

rotork



Pakscan IIE Master Station System Manual

Software Level

This manual relates to Pakscan IIE master stations fitted with software versions

V25 (5206-014) software version 5.8 or greater

Loop Driver (5206-034) software version 5.2 or greater

As we are continually developing our products their design is subject to change without notice.

© The contents of this document are copyright and must not be reproduced without the written permission of Rotork Controls Ltd.

The name Rotork is a registered trademark

Windows is a registered trademark by Microsoft Corporation

Modbus is a registered trademark by Modbus IDA

Contents

Glossary of Terms	7
Abbreviations	7
How to use this Manual	9
Software level	9
1 INTRODUCTION	11
1.1 Related Documents.....	11
2 EQUIPMENT DESCRIPTION	13
3 STORAGE PROCEDURE	15
4 OVERVIEW OF PAKSCAN.....	17
4.1 Field Control Units	17
4.2 Control and Indication	18
5 FUNCTIONS.....	19
5.1 Cable Fault Protection - Loopback system	19
5.2 Current Loop Start Up Operations	19
5.2.1 Loop Configuration	20
5.2.2 Normal Running Operation	20
5.3 Modbus Serial and Ethernet Interfaces	21
5.4 Local User Interface (LCD and Keypad)	21
6 INITIAL SETTING UP.....	23
6.1 Jumper Settings	23
6.2 External Links.....	25
6.3 Display Screen Contrast	26
7 INSTALLATION AND CONNECTION.....	27
7.1 Mounting	27
7.2 Mains Power	27
7.3 Field Wiring.....	28
7.3.1 Screen Connections	29
7.4 Loop Checks.....	29
7.4.1 Loop Continuity	29
7.4.2 Screen Continuity	30
7.4.3 Cable Capacitance	30

8	LOCAL USER INTERFACE	33
8.1	Front Panel Indication LEDs	33
8.2	LCD Screen and Keypad	34
8.3	Keypad Security	35
8.3.1	Using a PIN.....	35
8.4	Menu Structure.....	35
8.5	Master Station Status	38
8.5.1	Master Station Commands	39
8.5.2	Master Station Alarms - Text Description	40
8.6	Configuration Mode Screen	41
8.7	Diagnostic Menus	42
8.7.1	Top Diagnostic Display	42
8.7.2	Modbus Port Diagnostic Displays.....	43
8.7.3	Printer port diagnostic display	44
8.7.4	Loop Diagnostic Display	45
8.7.4.1	FCU Map and Failure Counts	47
8.7.4.2	Loop Speed Test.....	48
8.7.4.3	FCU Address Fault Details.....	49
8.7.5	Hot Standby Inter Unit Diagnostic Display.....	50
8.8	Setup Menus.....	51
8.8.1	Top Setup Menu	51
8.8.2	Port Setup Menus	52
8.8.2.1	Alarm Linkage	53
8.8.3	Data transfer to Standby Unit	54
8.8.4	Loop Setup Menu	55
8.8.4.1	Further Loop Options	56
8.8.5	Unit Address Setup Menu.....	57
8.8.6	Tag Setup Menu	58
8.8.7	Date and Time Setup.....	59
8.8.8	ESD Options Setup Menu	60
8.8.9	Keypad Security Options	61
8.9	Field Unit Menus	62
8.9.1	Actuator Field Unit Status Display	62
8.9.1.1	IQ Actuator Second Status Page	63
8.9.1.2	IQ and IQT Historic Torque Displays	64
8.9.2	Flowpak Actuator Field Unit Status Display.....	65
8.9.3	General Purpose Field Unit Status Display	66
8.9.3.1	Second Page for General Purpose Field Unit.....	67
8.9.4	IQ Analogue Input Field Unit	68
8.9.5	Communications Failure Display	69
8.9.6	Field Unit Status Secondary Data	70
8.9.7	Field Unit Alarm – Text Description	71
9	SETTING PARAMETERS	73
9.1	Initial Decisions.....	73
9.2	Serial Communication Ports.....	74
9.3	Loop Data.....	75

9.4	Tag Names	76
9.5	Date and Time.....	76
9.6	ESD Configuration	77
9.7	Security Access Level	77
9.8	Final Checks	77
10	SETTING A HOT STANDBY PAIR PARAMETERS	79
10.1	Copy Data A to B.....	79
10.2	Changes to Terminal Connections.....	79
10.2.1	Main/Standby Connections.....	79
10.3	Hot Standby Parameter Setting and Options.....	81
10.4	The PS300 Keyswitch	81
11	INCLUDING A PS410 CONVERTER	83
11.1	Jumper functions	84
11.1.1	PS410 port 2 to RS485 setup.....	84
11.1.2	PS410 port 1 to RS232 setup.....	85
11.1.3	LED functions	85
11.1.4	RS485 line conditioning.....	85
11.1.5	2-Wire and 4-wire RS485 communications	86
12	SETTING UP AND USING THE PS600 ETHERNET MODULE	87
12.1	Internal Connections	88
12.2	Connecting to the Ethernet Bridge	88
12.2.1	Local Ethernet Connection	89
12.2.2	Direct Ethernet Connection to a PC	89
12.2.2.1	Connection using Windows XP	89
12.3	Ethernet Module Status Indicators.....	90
12.3.1	LED Functionality.....	90
12.4	Setting Up the Module	91
12.4.1	Setting the Serial Connection Fields	92
12.4.2	Setting the User Fields for the Web Browser	93
12.4.3	Setting the Alarm Messaging Information.....	95
12.4.4	Setting the Local Area Network Connection Parameters.....	96
12.5	Using the Ethernet Connection	97
12.5.1	Master Station Overview	97
12.5.2	Master Station Configuration	98
12.5.3	Network Diagnostics.....	99
12.5.4	FCU Menu	100
12.5.4.1	Field Unit Status and Control	101
12.5.4.2	Field Unit Alarms screen	102
12.5.4.3	IQ and IQT Actuator Torque screen.....	102
12.5.5	FCU Parameters.....	103
13	COMMISSIONING THE SYSTEM	107

13.1	Checking Individual Field Units.....	107
13.2	Checking the Loop Itself	108
13.3	Checking System Performance	110
13.3.1	Setting the Loop Driver Voltages.....	110
13.4	Diagnostic Information	111
13.4.1	Loop Configuration	111
13.4.2	Loop Communications	112
13.4.3	Loop speed reprogramming	112
13.4.4	Checking Host Communications	113
13.5	Final Checks	113
13.6	Commissioning Aids	114
14	MASTER STATION SOFTWARE VERSION	115
15	SET UP DATA RECORDS.....	117
15.1	Loop Map	118
16	TECHNICAL SPECIFICATIONS.....	121
16.1	Master Station	121
16.2	Actuator Field Units.....	121
16.3	GP Field Unit.....	122
16.4	2-Wire Loop	122
16.5	External Connections	124
16.5.1	Loop Connections and Digital I/O	124
16.5.2	Serial Ports	125
16.6	Printer Messages	127
16.7	Maintenance	127
16.8	Master Station Dimensions.....	128
17	GENERAL SAFETY INFORMATION.....	129

Glossary of Terms

Address	The unique address for a field unit on the Pakscan loop, range 1-240
Loop	The digital, twisted pair 2-wire data communication link
Field Unit	The Pakscan option card fitted to the actuator, or complete General Purpose field unit
Master/Slave	The method of communication used on the field loop. The master station controls the data exchange on the highway
Node	A single device (address) on the Pakscan loop
RS485	The electrical properties as defined by the IEA485 standard, 2-wire twisted pair.
RS232	The electrical properties as defined by the IEA232 standard

Abbreviations

Comms	Communications
FCU	Pakscan Field Unit
RAM	Random Access Memory
ROM	Read Only Memory
RTU	Remote Terminal Unit
SW	Software

Rotork Controls Limited
Brassmill Lane
Bath, England BA1 3JQ

telephone 01225 733200
telex 01225 333467
<http://www.rotork.com>
mail@rotork.co.uk

rotork



Declaration of Conformity

Rotork Controls Ltd.,
Brassmill Lane,
Lower Weston,
Bath,
BA1 3JQ
ENGLAND

declare under our sole responsibility that the

Pakscan IIE Master Station Modules
Pakscan IIS Master Station
Pakscan Field Units

conform to the essential protection requirements of the Low Voltage Directive 72/73EEC, amended by 93/68/EEC, by the application of BS EN 61010-1: 2001.

and that the above products conform to the protection requirements of the EMC Directive 89/336/EEC, amended by 92/31/EEC and 93/68/EEC, by the application of BS EN 61326: 1997 (amendment A1).

Issued in Bath on 8th April 2003

Signed

A handwritten signature in black ink, appearing to read 'W Whiteley'.

William Whiteley
Managing Director

Holding company Rotork p.l.c. Registration England 608345. Registered office: Rotork House, Brassmill Lane, Bath BA1 3JQ

How to use this Manual

In order to make the best use of the information in the following pages we suggest you use this manual as follows:

- Familiarise yourself with the hardware - section 4 will show you all the parts
- Read sections 4 to 12 before attempting to commission the system
- Refer to section 6 to check the internal link settings
- Section 8 relates to the front panel LED's, keypad and LCD screen
- Make sure you understand how to connect the system - section 7 tells you how
- Set up the Software selected parameters - also see section 9
- With a Hot Standby system check the information in section 10
- Commissioning the system is explained in section 13
- If you have RS485 Converter units, read section 11 carefully
- Ethernet connections are explained in section 12
- Record the information about your system on data sheets such as those outlined in section 15, or use Rotork MasterTools to document the system. Pakscan Ethernet systems can also record the master station data to file from the web server application.

Software level

This technical manual relates to Pakscan IIE master stations with software version **5206-014 V5.8** or later for the main V25 processor and version **5206-034 V5.2** or later for the loop processor.

MasterTools

The software utility, MasterTools, runs on a PC and maybe downloaded from www.rotork.com. With this utility a complete record of the Pakscan loop, the field units and master station settings can be made and retained either as an electronic file or the data may be printed out.

(This page is intentionally blank)

1 INTRODUCTION

This document describes the procedures for setting up commissioning and running a Pakscan IIE system. If the unit is to be stored for a period of time prior to its use, then please refer to section 3 for information about storage of electronic equipment.

The Pakscan IIE master station hardware is a stand-alone unit requiring only the connection of power and suitable field units to operate. This manual describes the Pakscan IIE master station only. Please refer to the documentation relating to the field units for information on that part of the system.

The Pakscan IIE system is compatible with all Pakscan II and IIE field units and setting tools. The Pakscan IIE is equipped with either serial communication ports, or Ethernet ports, or both through which the master station can be controlled and operated from another device. The communication protocol supported by these ports is Modbus RTU and Modbus TCP and details of the function codes and data base organisation established within the master station are contained in the associated protocol documents.

1.1 Related Documents

There are a number of documents for the Pakscan system that relate to the Pakscan IIE master station these include:

General

- | | | |
|-----|---|----------|
| (1) | Field Test Unit Technical Manual (Paktester) | S178E |
| (2) | Master Station Test Unit Technical Manual (Pakreader) | 5161-021 |
| (3) | Pakscan IIE RS485 Converter Technical Manual | 5218-023 |

Serial Communications

- | | | |
|-----|--|-------|
| (4) | Pakscan Modbus Interface Specification | S171E |
|-----|--|-------|

(This page is intentionally blank)

2 EQUIPMENT DESCRIPTION

The master station is an assembly of a computer card, a current loop interface card, a power supply card, and a front panel with an LCD screen and 16-key keyboard, fitted to a standard 19-inch rack. The rack will contain some or all of the items identified in Fig. 1.

- PS100 CPU and Display Module (two off in Hot Standby systems)
- PS210 Power Supply module (unless the hardware is supplied by 24V dc)
- PS300 Switch module for Hot Standby systems only
- PS410 RS485 Converter (optional)
- PS601/2/3/4 Ethernet port converter

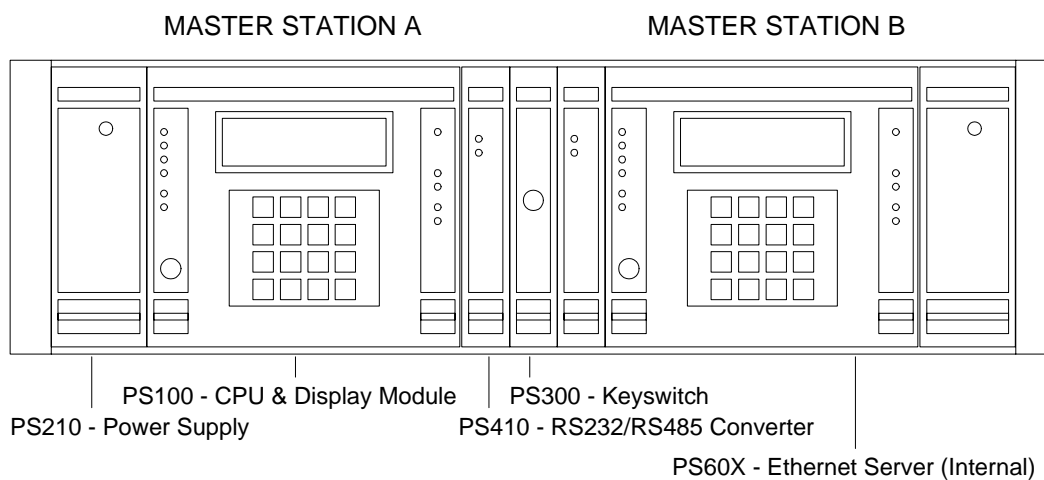

Fig 1: Pakscan IIE Master Stations in a 19 inch rack

The rack can accommodate two master stations, when viewed from the front these are referred to as M/S A on the left and M/S B on the right. The 19-inch rack is always fully wired to accommodate all variations of assembly within it. Some applications may require external links on the connectors and terminal blocks and these will normally be fitted before despatch. It is advisable to check that any links that may be required for a particular application are in place. When PS601 or PS602 Ethernet servers are fitted there will be links to the Port 1 or Port 2 connectors and these will not be available for host connections.

All master stations have their own dedicated power packs, each operating from an independent input. In the case of a dual or hot standby system there maybe two independent supplies to the rack.

Optional additional cards may be fitted to the master station rack for converting the communications hardware between RS232 and RS485, and in the case of a Hot Standby a switch unit is also included. If the master station includes Ethernet connectivity then there are internal servers fitted inside the rack. Where no cards are fitted blanking plates are used to cover the resulting space.

Two master stations may optionally be interconnected to form a dual redundant system. In this configuration, one unit controls the loop, whilst the other acts as a 'hot standby'. Changeover between the units can be automatic or manually triggered.

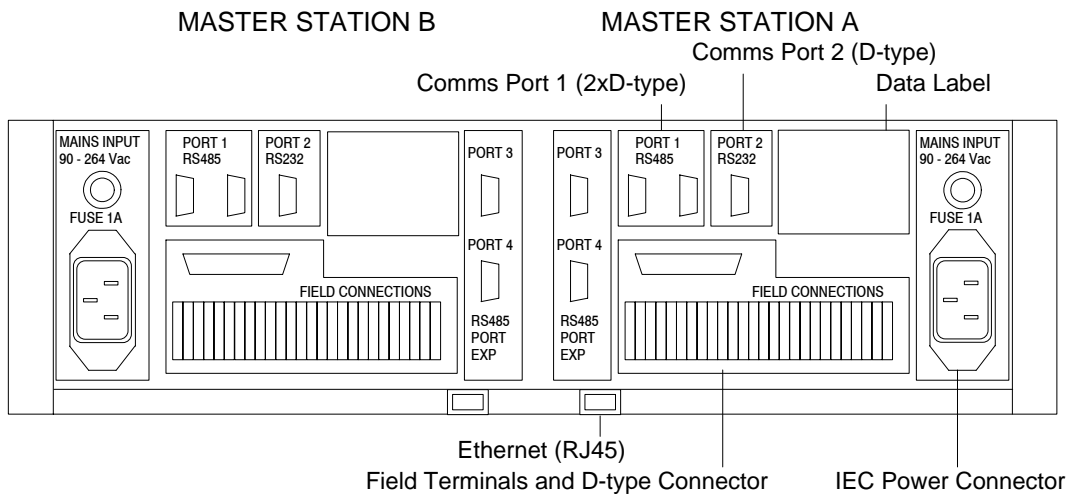

Fig 2: Pakscan IIE Master Stations – rear view

On the rear are the following items, repeated for both M/S A and M/S B.

- Power Connector (IEC) for use with a.c. powered units (when a 24V dc supply is used this is replaced by a terminal block). There is a 1 Amp slow blow fuse adjacent to the power connection.
- 26 screw terminals for Field Connections, of these 25 only are used, and terminals 1 to 21 are directly linked internally to the 25 way D type connector (pins 1 to 21) above the terminal block.
- Two 9 way D type connectors for Comms Port 1, a male and a female. This port is always RS485, 2-wire.
- A single 9 way D type female connector for Comms Port 2. This port is always RS232.
- There are two further connectors, 9 way D type female, for Ports 3 and 4. These are only used if the optional RS232/485 Protocol Converter Module, PS410, is fitted, as described in section 11.
- One trailing RJ45 female socket for connection to the Ethernet server when one is fitted.

For host computer communications either serial or Ethernet connections can be used. The data format for information exchange is Modbus RTU (for serial ports) or Modbus-TCP (for Ethernet LAN connection). There are multiple data bases within the master station and these are explained later in this manual.

Support for a printer to log alarms is provided. Each entry can be tagged with the time and date. There are contact outputs for various alarm conditions, and provision for an Emergency Shutdown ('ESD') input. Emergency Shutdown may be invoked by breaking the circuit between two terminals at the master station causing an 'ESD' message to be broadcast on the current loop. Field units and actuators may be set up to carry out an appropriate action, e.g. close a valve.

3 STORAGE PROCEDURE

On receipt the hardware should be examined for signs of damage and to ensure that the expected equipment is present. Identify all the parts.

If the unit is to be stored for a period of time then normal conditions for keeping electronic hardware must be provided.

The ambient conditions should remain in the following bands at all times:

Temperature: 10 - 30 degrees Centigrade

Humidity: Not to exceed 80% R.H.

The equipment should not be stacked, though it may be stored in any orientation. The original packing should be retained. **DO NOT LOSE THE MANUALS.**

If it is to be kept for a prolonged period then an electrical exercise test is recommended every 6 months, for 24 hours. The master station internal battery has a shelf life of 3 years.

(This page is intentionally blank)

4 OVERVIEW OF PAKSCAN

The Pakscan system is a control and monitoring package comprising a master station, 2-wire serial data cable wired in a ring or loop and a number of connected actuators with Pakscan field units fitted. The fieldbus loop can have up to 60, 120, 180 or 240 field units connected depending on the capability of the master station, and the cable can be up to 20 km long. The length of the 2-wire cable (loop length) can be considered as the circumference of a circle starting and finishing at the master station.

The master station is a single module in a 19-inch rack. It may have a supporting, identical, standby unit. Details of setting a Hot Standby pair are covered in Section 10. In essence, the Hot Standby simply comprises two identical master stations each of which is set identically to its partner. In some cases two master stations are fitted into one 19-inch rack (there is space for two). These can be considered as two independent units.

The current loop is single fault tolerant and can withstand either an open circuit, short circuit or ground connection fault and still maintain communication with all the field units. Subsequent faults do not stop the complete system from working and the parts that remain connected to the master station will continue to be in communication with it.

In addition to controlling the loop, the master station also provides the external interface to the system. It supports 2 serial ports for communications to host computers, as well as providing a local user interface. Alternatively, one of the serial ports may be used to drive a printer to log alarms. In the Pakscan Ethernet version one or both the serial ports are replaced with a standard 10Base-T Ethernet ports. When a single Ethernet port is available the remaining serial port may be either RS232 or RS485 depending on the option chosen.

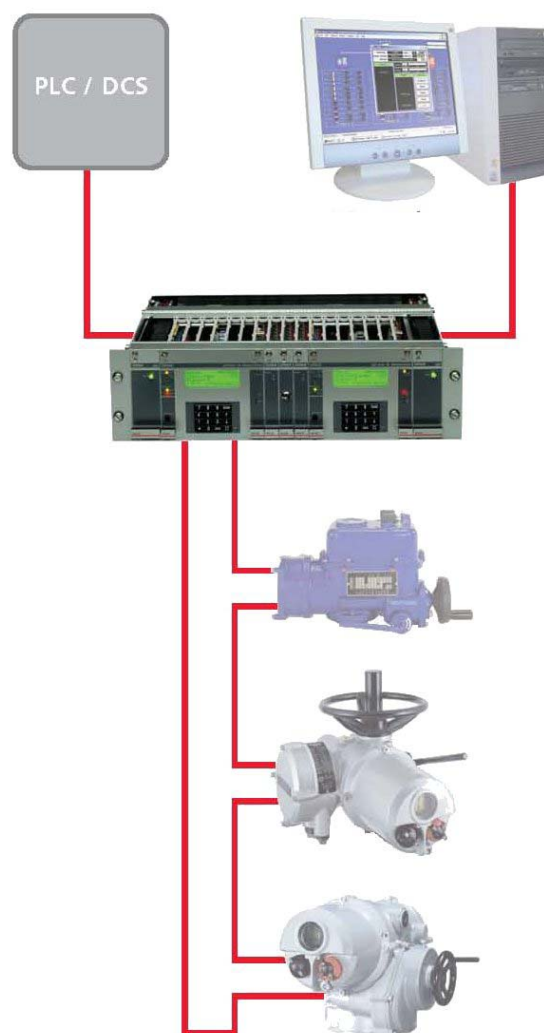

Fig 3: Pakscan IIE System Diagram

4.1 Field Control Units

A range of field control units ('FCU's) is available to cater for specific application areas. These may be summarised as follows:

- ❑ Integral type field control units mounted within a Rotork actuator electrical housing such as the IQ, IQT or Q range actuator.
- ❑ Externally mounted field control unit. Various packages are available, including 'Pakbox', weather-proof box, or rack mounting. The unit may be used for either actuator control applications, or for general purpose applications such as pumps, blenders etc. Its complement of I/O is 8 digital inputs, 4 changeover relay outputs, 2 analogue inputs and 1 analogue output.

4.2 Control and Indication

The field units each report information to the master station that can be viewed on the integral LCD display, or collected from the serial communication port of the master station for use on another display system. The reported data is already organised and requires no configuration by the user; each field unit automatically reports all its available data.

Commands to operate the output devices may be sent over the system, the initiation of the command can either be from the integral keypad (under the correct access code) or from the serial or Ethernet data link. Once again the organisation of these commands is already configured and the user only has to address the correct register to implement the command.

5 FUNCTIONS

5.1 Cable Fault Protection - Loopback system

Communication between the master station and the field control units is via a twisted pair 2-wire cable carrying a 20 mA current in a loop. In normal operation the current flows round the loop on one wire and returns via the master station on the second wire. If high-speed operation with 'doubling on' is selected the current returns inside the master station and the second wire is not used.

Each field control unit has the capability to connect the 2 wires together (apply a loopback circuit), and this mechanism is used to divert the current in the event of a loop fault. With field units each side of a loop fault 'in loopback', the system can still communicate with all field units by operating the system as 2 segments. If there are 2 loop faults, those field units between the faults will be isolated.

A loop cable fault may be an open circuit, a short circuit, or an earth fault.

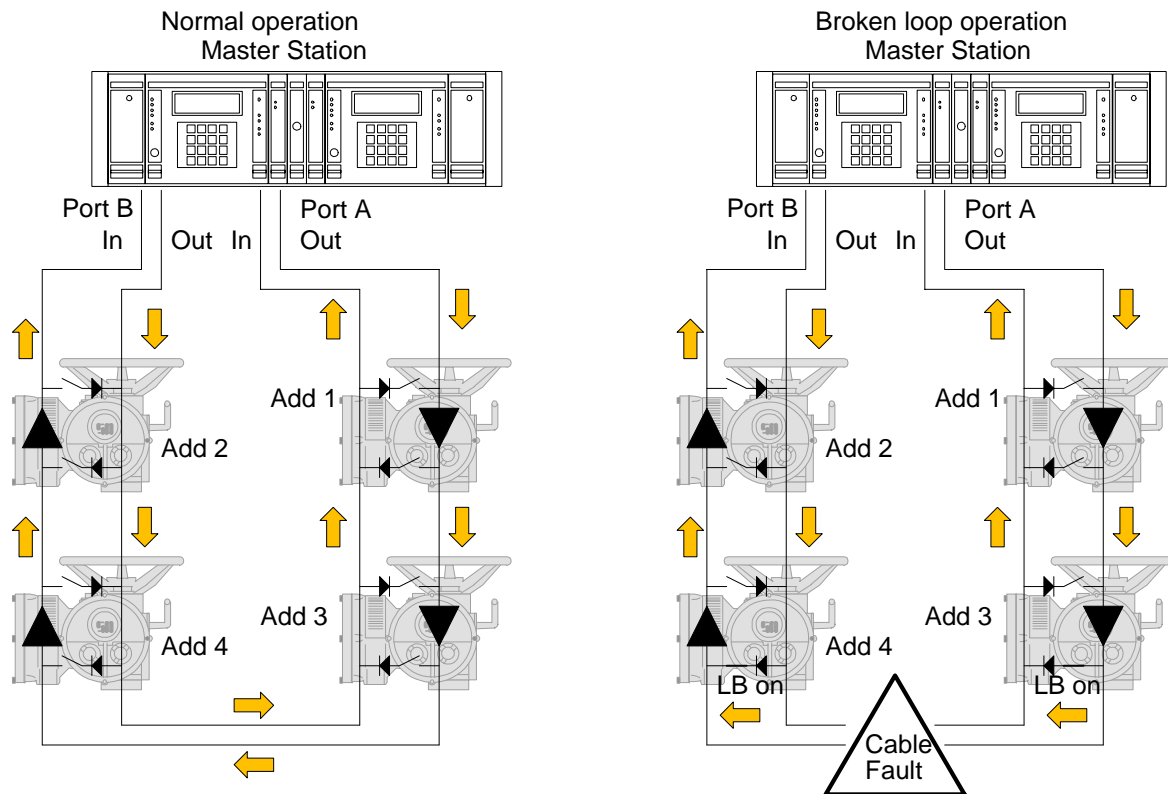

Fig 4: Loopback system

5.2 Current Loop Start Up Operations

The Pakscan IIE controls the current on the loop to communicate with the attached field units. Loop communication divides into two parts: configuration (when the master station decides whether the loop is complete, and if not, where the faults are), and normal operation.

5.2.1 Loop Configuration

The loop configuration phase is entered after power-up, after a loop fault is detected, or after a loop configure command is received.

Configuration consists of the following steps:

1. Wait for all the field units to go into loopback. The time is dependent on the baud rate.
2. Issue a command from Port A to ask a field unit in loopback for its address. This finds the first field unit.
3. Use that address to tell the field unit to remove its loopback.
4. Repeat steps 2 and 3 until no more field units are found.
5. Attempt to send a message right round the loop and receive it back at the sending end. This tests the integrity of the complete loop.
6. If the loop is complete stop here. If the loop has a problem execute steps 7 to 10.
7. Repeat steps 2 to 4 from Port B.
8. Again wait for all field units to go into loopback.
9. Remove loopbacks one field unit at a time from Port A until only the last field unit is left in loopback.
10. Repeat step 9 for Port B.

Loop configuration will identify and mark as out of service any field unit found which has an address that is zero, an address that is the same as one which has already been found, or which has an address, which is too high. An address that is too high is one outside the range selected for the master station.

The master station has the facility to double the loop Baud rate. If this facility is enabled, via the Keypad, the master station will issue a broadcast command to all the field units to get them to double the baud rate they are using, once it has detected that the loop is complete.

5.2.2 Normal Running Operation

In normal operation, the master station polls each field unit for any changed data it has to report. Most of the time, field units have no changes to report, and traffic on the loop is kept to a minimum. Field units are polled in address order. Data that might be reported includes changes to digital inputs, alarm changes, or significant changes to an analogue input.

If a field unit, which previously responded on the last scan, fails to respond correctly the master station will retry twice to get a reply. On subsequent scans only a single attempt is made to get a response.

All field units up to the address preset in the master station database are polled. Thus new field units which are powered-up on a working loop will be identified by the master station, provided they are within the selected address range, and future scans will poll the new field unit for data.

Commands to field units (open, close, etc.) are interleaved between polls to individual field units. This ensures they are sent as soon as a slot is available. When the current transaction is completed the command will be next.

A check is made at the end of each scan to see if a loop fault has occurred. For a complete loop with no loopbacks present a test message is sent round the loop; for a broken loop (loopbacks in use)

communications failure to the last field unit on either side is taken as an indication of a fault. In the event of a new fault, loop re-configuration is initiated.

5.3 Modbus Serial and Ethernet Interfaces

The Pakscan IIE master station is provided with two interfaces for data exchange with external host systems. These may be a combination of one serial and one Ethernet, two serial or two Ethernet connections. In addition one port can be selected for serial printer use. For Ethernet connections one or more PS601, PS602, PS603 or PS604 modules must be fitted. In all cases the interfaces behave similarly and always use Modbus RTU or Modbus TCP for the data communication protocol.

The master station's use of the Modbus RTU protocol is described in detail in the protocol documents listed in section 1 (Related Documents). The master station may operate slightly differing protocols data bases from each of its two ports. The protocols available are indicated on the set up screen display, (see screen displays section). Modbus TCP behaves in a similar manner to Modbus RTU and the register locations are the same for both protocols.

The two serial ports can both issue commands to field units via the master station, and to the master station itself. Three separate registers of field unit alarms are maintained by the master station, one for each serial or Ethernet port and one for the front panel display. This ensures that alarms cannot be missed by any of the interfaces. If the host system is reading alarms from both the serial data bases it must consider each one separately and perform the read and accept routines for each serial link. Accepting an alarm on either serial interface does not accept the alarm on the display, or vice versa.

The alarm handling on the Modbus TCP Ethernet link is different. If the host protocol is selected as Yokogawa then the alarm handling is exactly as for the RTU serial data and alarms are held until accepted. If the protocol is selected as Generic then the Web Server will be populated with data; alarm handling is similar to the other serial data bases, but now either the web server or the external Ethernet host can accept the alarm on the associated data base. Effectively there is one alarm register for the IP address and both the web server and host access the same register and accept the same register.

5.4 Local User Interface (LCD and Keypad)

The Local User Interface allows the master station to be interrogated directly for its own status and diagnostic information, and for field unit status. Various parameters may also be configured from the front panel and commands sent to field units. The available screens are illustrated later in this manual.

(This page is intentionally blank)

6 INITIAL SETTING UP

The factory default settings for the jumpers and links inside the master station will be satisfactory for most applications. However there are some cases where special settings could be required. Before applying any power to the master station check that the internal settings of the jumpers match the system requirements. These jumpers will have been factory set to the default positions, or to user specified positions, prior to dispatch.

In addition to the internal jumpers there may be a need to fit external links to achieve satisfactory operation of the installed unit, for example with Hot Standby units. These links can be fitted prior to installation.

6.1 Jumper Settings

The PS100 CPU and Display module contains a number of jumpers to set some of the parameters for the performance of the unit. These are factory set and should generally not require adjustment at any time. However there are links that may need to be fitted to match specific applications. There are no jumper links on the power board, display board or loop driver board that require customer adjustment.

The diagram Fig. 5 is a top view of the PS100 module showing the different circuit boards. Fig. 6 shows the layout of the V25 card of the module. This is the PCB located to the left of the display screen when viewed from the front; it is clearly distinguished by the battery on the board.

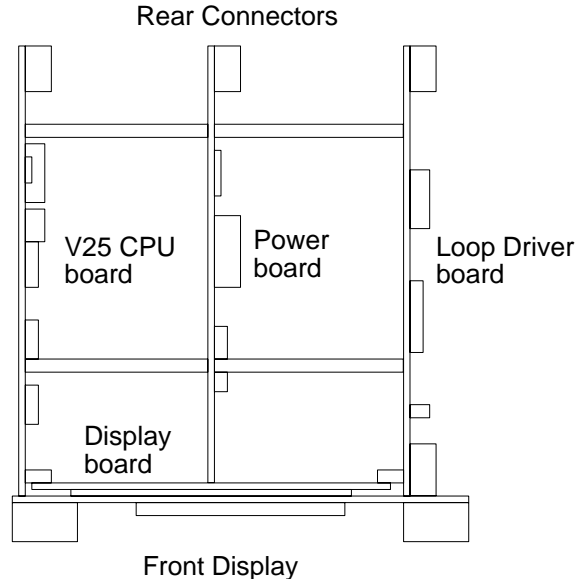
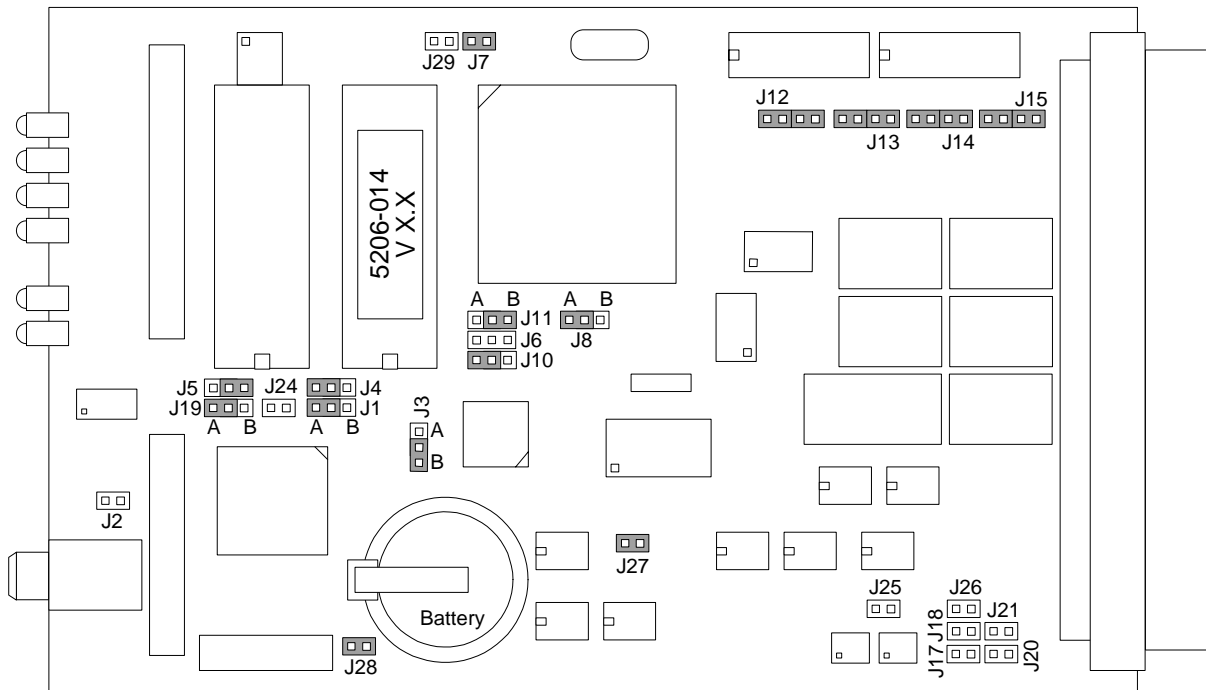

Fig 5: The PS100 card positions

The function and default settings of the jumpers is listed in the table, please note that some select the type of integrated circuit used, and therefore may vary from one unit to another.



Jumper No	Description	Function	Setting
J1	Reset jumper	Normal operation Override reset Hold in reset	A Not fitted B
J2	RAMWR jumper	Normal operation Full RAM access	Link 1 - 2 Not fitted
J3	CTR CLK2 jumper	CTR CLK2	Freq - A ISAF - B
J4	MEMWR	MEMWR	Flash - B EPROM - A
J5	RAM (A12) jumper	A12	Fitted
J6	ROM (A17) jumper	A17	Fitted
J7	IRQ jumper	IRQ enable IRQ disable	Not fitted Fitted
J8	CTS jumper	CTS enable CTS disable	Link 1-2 Link 2-3
J10	ROM (A18) jumper	A18	Fitted
J11	ROM (A15) jumper	A15	Fitted
J12 to J15	Digital input jumpers	Un-isolated Isolate channel	Link 1-2 & 3-4 Link 2-3
J17 & J18	RS485 termination jumpers J17 = data, J18 = RTS	Termination No Termination	Fitted Not fitted
J19	RAM (A16) jumper	A16	Fitted
J20 & J25	RS485 bias jumper	RS485 bias data	Fitted
J21 & J26	RS485 bias jumper	RS485 bias RTS	Fitted
J24	FPGA write jumper	Enable local FPGA write	Fitted
J27	CTS1 jumper	CTS1 enable (RS485 only)	Fitted
J28	Battery jumper	Disconnect battery Connect battery	None Fitted
J29	INTP2 jumper	Enable INTP2	Fitted

Fig 6: Master Station V25 card internal links

❑ **J8 – CTS Function Select for Port 2**

Link 2-3 (default setting) causes the master station to ignore the RS232 CTS line on Port 2. If the link is placed in 1-2, then the connected serial device may control the output of the master station on Port 2. This may be required if Port 2 is operating a printer.

❑ **J17 and J18 – RS485 Termination**

These allow for two terminating 100 ohm resistors to be connected to the RS485 lines to prevent signal reflections. These jumpers are not normally fitted as if there are too many terminating resistors connected the line function will deteriorate due to the electrical loading. However all RS485 data highways should include terminating resistors at either end of the highway, i.e. at the host and at the last device.

❑ **J20 and J25 / J21 and J26 – RS485 Bias**

These allow for four biasing resistors (470 ohm) to be connected to the RS485 lines to pull them apart. These jumpers should not normally fitted as if there are too many bias resistors connected the line function will deteriorate due to the electrical loading. However all RS485 data highways should include bias resistors in a single location. If a PS412 stand-alone converter is used in the system then the pull apart resistors in that unit will already be connected.

❑ **J28 - Battery Backup**

Link 2-3 connects the battery, linking 1-2 isolates the battery. If the battery is disabled, or removed, for any length of time, e.g. greater than 1 hour, the settings on the master station may be lost. The battery maintains the type of station, the clock, and any user set parameters.

Note: The battery should never be disconnected except in extreme circumstances.

6.2 External Links

Some of the functions of the master station are settable by external connections. These connections may come from other pieces of plant where a contact opening or closing forces a master station action, or they may be fixed for the application.

The function and setting of these links is described here.

❑ **Terminal 10 & 11 – ESD (Emergency Shutdown)**

The Pakscan system may be configured (on software version 5206-014 V3.2 or higher) for a global command to 'ESD' all the connected devices. One source of the ESD command is connected as an input to these terminals.

When configured to do so, the system will issue continuous ESD commands to the Loop whenever these two terminals are unconnected. A remote ESD contact, process normal closed, may be connected. If the contact opens, then an ESD is issued.

If the ESD function via these terminals is not required then it may be removed from the configuration or, if it remains an enabled option, a link MUST be fitted between these terminals.

❑ **Terminal 22 & 23, Terminal 24 & 25**

If the master station is not part of a hot standby pair, that is, it is a single stand-alone unit then two links **MUST** be fitted. (A hot standby pair always includes the PS300 switch module in the centre of the rack.)

If the rack does not contain a PS300 Switch module:

Link terminal 22 to 23

Link terminal 24 to 25

6.3 Display Screen Contrast

On the front of the master station there is a multi-turn potentiometer that is used to adjust the contrast of the LCD display. Adjusting clockwise increases the contrast.

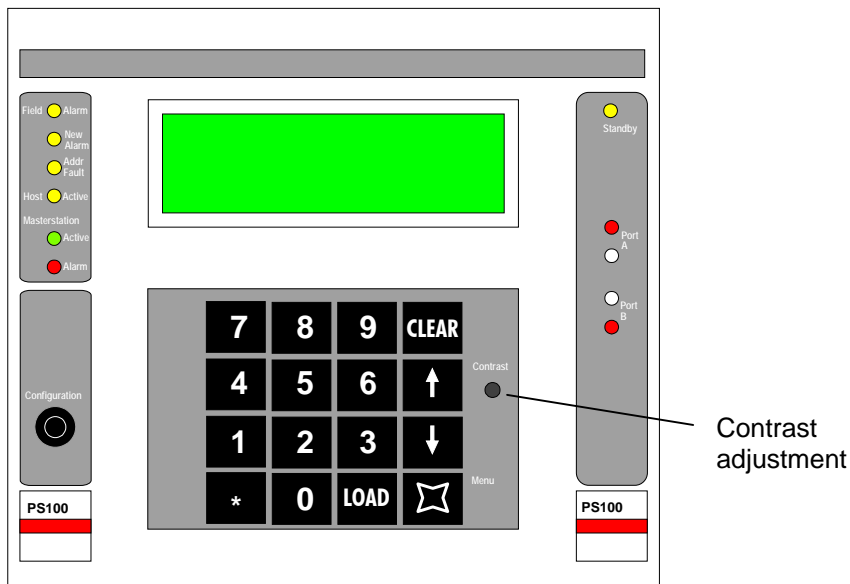

Fig 7: Master Station front panel

7 INSTALLATION AND CONNECTION

The master station is now ready for installation and connecting to the loop.

7.1 Mounting

The master station rack should be mounted horizontally in a suitable frame or cabinet. The height of the front should be between 1.0 m and 1.7 m above the floor so that the screen may be viewed and the keys accessed. There should be no equipment in front of the master station. At the rear ensure sufficient space is provided to access the terminals and connectors.

Ideally both front and rear access to the unit should be provided. However if rear access is not possible, ensure sufficient cable length is allowed for the rack to be withdrawn and placed safely when checks to the connections are required.

All connections are to the rear of the rack.

7.2 Mains Power

The individual master stations in the rack each require their own power feed. When ac power is used this is connected by an IEC connector.

The unit will operate on an ac supply between 90 and 264 volts, 43 to 440 Hz, single phase.

[For dc systems a suitable dc supply must be arranged (24 V dc nominal, range 21-30 V dc), this is connected to the screw terminals on the rear of the unit, and each master station still requires its own supply feed.]

It is essential that an Earth connection is made to the master station via the IEC connector, and/or the safety earth stud.

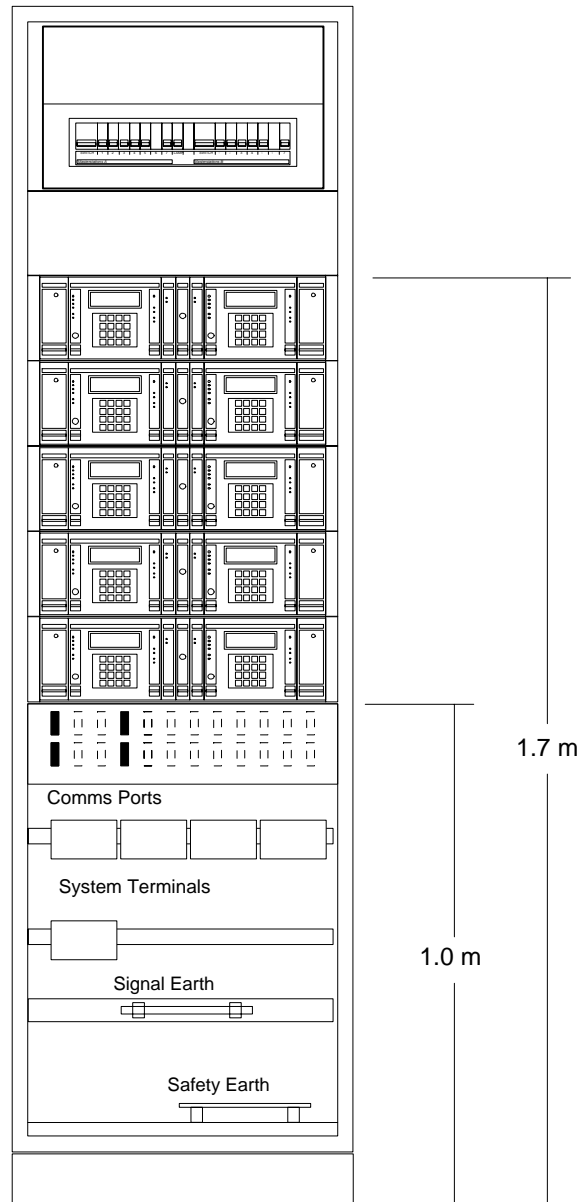

Fig 8: Typical system cabinet

7.3 Field Wiring

The field wiring includes the loop wires to the field units. The loop cable should have an overall electrical screen. Particular attention should be paid to the connection of the screen on this cable.

The wiring should be in accordance with the diagram Fig. 9. (For connecting up a Hot Standby system refer to section 10.)

Note that the system is a current loop, and that Port A Out, (terminal 12), connects via all the field units to Port B In, (terminal 16), whilst Port B Out, (terminal 15), connects similarly to Port A In, (terminal 13). If a coloured pair, red and blue, is used this results in say the red wires being in terminals 12 and 16, with the blue wires in 13 and 15. The order is red, blue, blue, red.

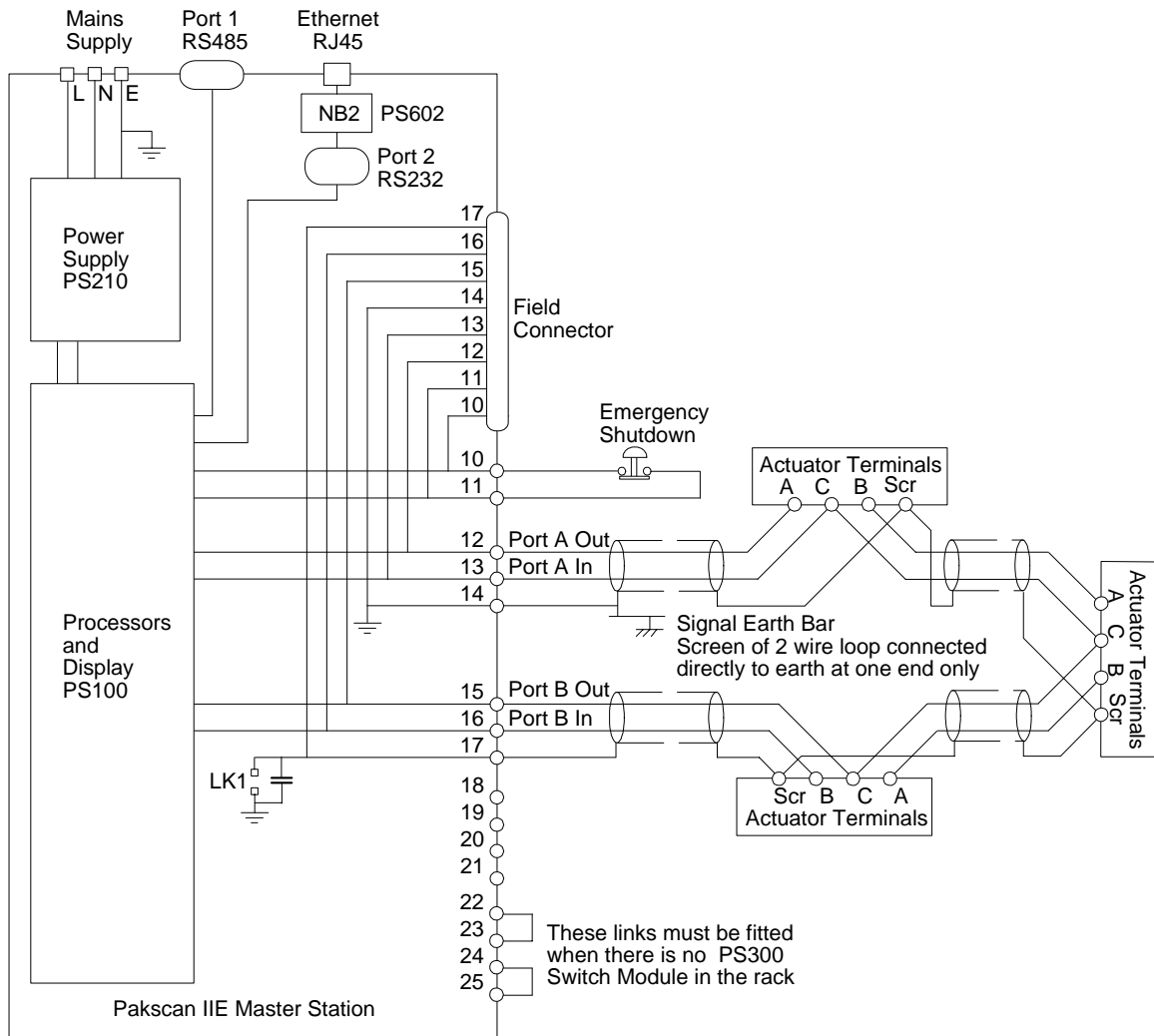

Fig 9: Typical System Wiring Diagram

7.3.1 Screen Connections

The screen terminal 14 is connected internally to the supply earth pin, and the chassis. Terminal 17 is connected to earth via a capacitor, (to meet the CE specification for EMC emission standard), or directly to earth if link LK1 for master station A or hot standby systems, or LK2 for master station B, is fitted. If no alternative clean earth bar is provided then the screen will have to connect to the supply or safety earth.

Note: The screen must only be connected directly to earth at one point, and at one end of the cable.

If you choose to use the internal earth point on terminal 14 or 17 you must ensure that a safety earth is connected to the master station. Connect the screen of the cable on one side only, say Port A using terminal 14. **DO NOT CONNECT THE SCREEN ON BOTH ENDS OF THE CABLE IF LK1 (LK2 for station B) IS FITTED.** If you connected the loop directly to earth at two or more points, an earth loop will result that will probably degrade the loop communications.

If your system includes a Signal Earth bar then connect the screen of one of the loop cables to this bar only. Do not link the bar to the master station earth via the cable screen and terminal 14.

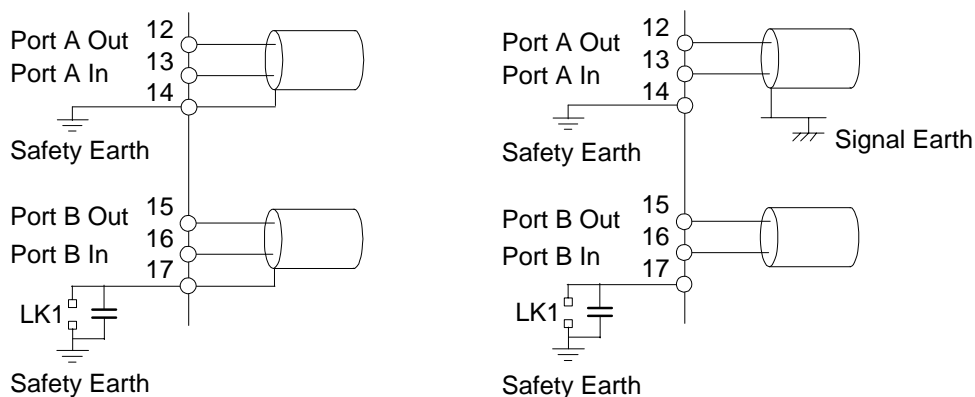

Fig 10: Typical Screen Connection

7.4 Loop Checks

Once the loop is fully wired there are a number of checks that should be made before power is applied to any of the connected field units, actuators, or the master station. These simple tests will always help in the setting to work of the system.

7.4.1 Loop Continuity.

With all the field units connected, but none of them powered up, check the continuity of the 2 cores of the cable using a simple resistance (ohm) meter. [The most common errors in installing the system occur on the field wiring.]

1. Disconnect all the loop wires and the screen from the master station.

2. Measure, and note down, the resistance of each core (the core connected to A and B will have a higher resistance than the core connected to the common).
3. Check the resistance between the cores, this should be a high resistance as they are not connected together. (Note that if a field unit has power to it, then the internal circuitry will connect the two cores together.)
4. Join the 2 wires that will be connected to Port B together and measure the total resistance of the whole loop cable - note this down as you will need it for reference later.

7.4.2 Screen Continuity

With the Port B cables still connected together make sure that the screen is isolated from the loop cores themselves, there should be a high resistance between screen and cores.

5. Check the screen is continuous by measuring the resistance of the screen between the two ends.
6. Check that the screen is isolated from earth by measuring the resistance between the screen and your screen earth point.

7.4.3 Cable Capacitance

The capacitance between the cores, and to the screen, is critical to the system performance. Too high a capacitance for the selected loop baud rate will result in poor communications, or even communication failure.

7. Disconnect the join between the 2 cores that connect to Port B, the cores and screen are now all separated.
8. With the digital meter set to capacitance, measure the core to core capacitance, and note it down.
9. Also measure the core to screen capacitance, which will probably be slightly higher, for cable core 1.
10. Measure the capacitance between core 2 and the screen.

If any problems are encountered during these tests rectify them before proceeding. The results should be noted on a form such as that shown overleaf.

Results of Cable Checks		
1	Resistance of Core 1 (A-B)	
2	Resistance of Core 2 (Common)	
3	Resistance between Core 1 and 2	
4	Total Resistance of both Cores [should be the total of (1) and (2)]	
5	Screen end to end Resistance	
6	Cable to Screen Resistance [should be high]	
7	Screen to Earth Resistance [should be high]	
8	Capacitance Core to Core	
9	Capacitance Core 1 to Screen	
10	Capacitance Core 2 to Screen [should be the same as (9)]	

(This page is intentionally blank)

8 LOCAL USER INTERFACE

The master station has indication LEDs to show the condition of the hardware and also contains the main 4 line LCD display and keypad. This section describes the use of this display panel and also the menu structure for access to the various screens and settings for the system.

8.1 Front Panel Indication LEDs

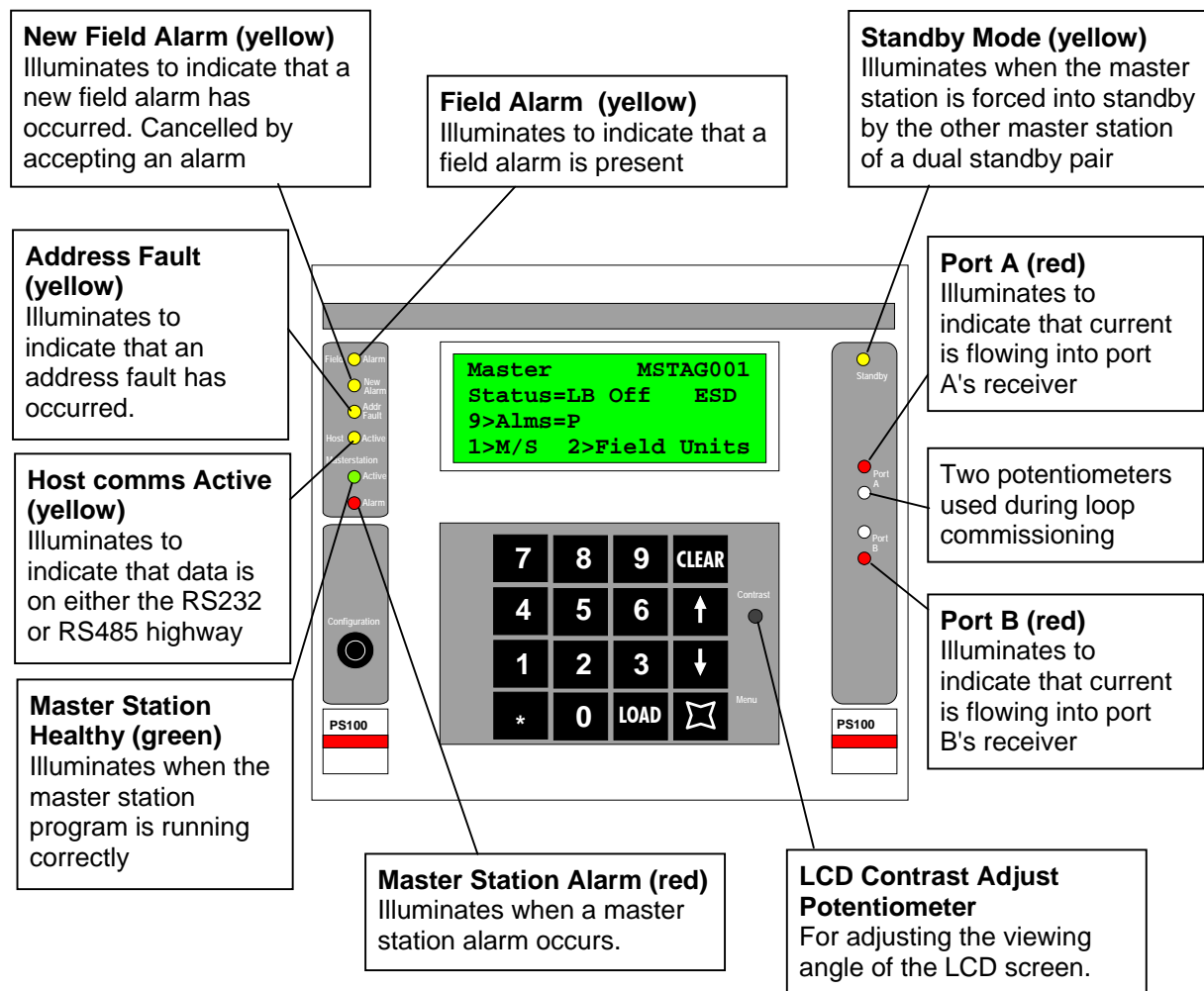

Fig 11: Master Station Front showing function of LED's

The Standby Mode LED will only illuminate in a hot standby master station, and then only on the unit that is currently in standby mode. This can be either the left or right hand PS100 module.

The loop activity indicators flicker as data is transmitted and received, if they both operate together the loop is complete, but if they alternate then a loop fault exists.

8.2 LCD Screen and Keypad

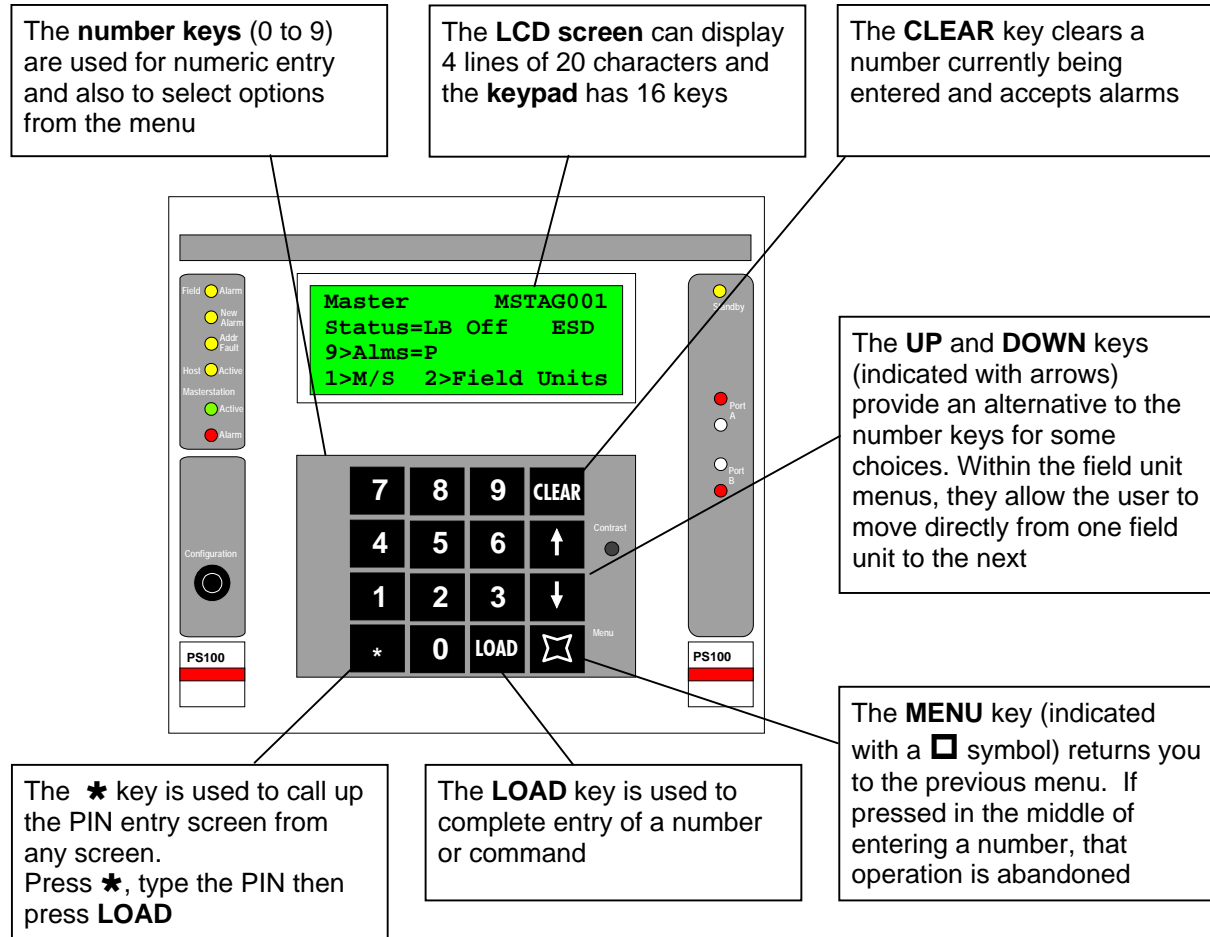

Fig 12: Master Station Front showing keypad and LCD screen

The screen is used to show the current status of the system and also to allow changes to be made to the configuration of the system. The keypad is always available to view data although alterations to settings and commands to valves can be prevented by the use of a PIN entry.

Like all LCD displays, the Pakscan screen has an optimum viewing angle and for best results the contrast should be adjusted when the station is finally mounted. On start up when power is first applied there is a delay before the screen shows the current status.

Navigation between the screens always uses numbers and the function of the numbers is displayed on the bottom line of the LCD. The menu structure used for the master station is shown in the next section.

All number displays on the LCD are decimal format.

8.3 Keypad Security

The Pakscan IIE master station can be protected against unauthorised changes by a password, or 'PIN', mechanism.

Note: If a PIN has been programmed, it must be entered before particular functions can be accessed. These functions then remain accessible whilst keys are being pressed and for 30 seconds after the last key press.

Note: It is not always possible to recover a 'lost' PIN. There is no default PIN. Once lost the only way to recover the system is to remove the battery which results in total data loss. In some cases, returning the unit to Rotork may allow a Pin to be recovered.

8.3.1 Using a PIN

The PIN can be entered from any screen by pressing the star key (*). The master station then prompts for a PIN that should be entered, followed by 'LOAD', before being returned to the previous screen. The numbers entered are not displayed as they are keyed.

8.4 Menu Structure

Each page offers the user options to enter commands or move to a different page. The structure of these menus is outlined in the diagram and detailed in the following sections. The menu pages that appear depend on the connected field units and options chosen.

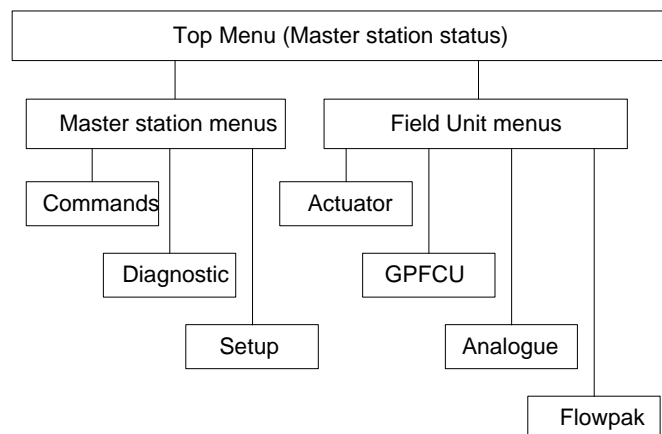
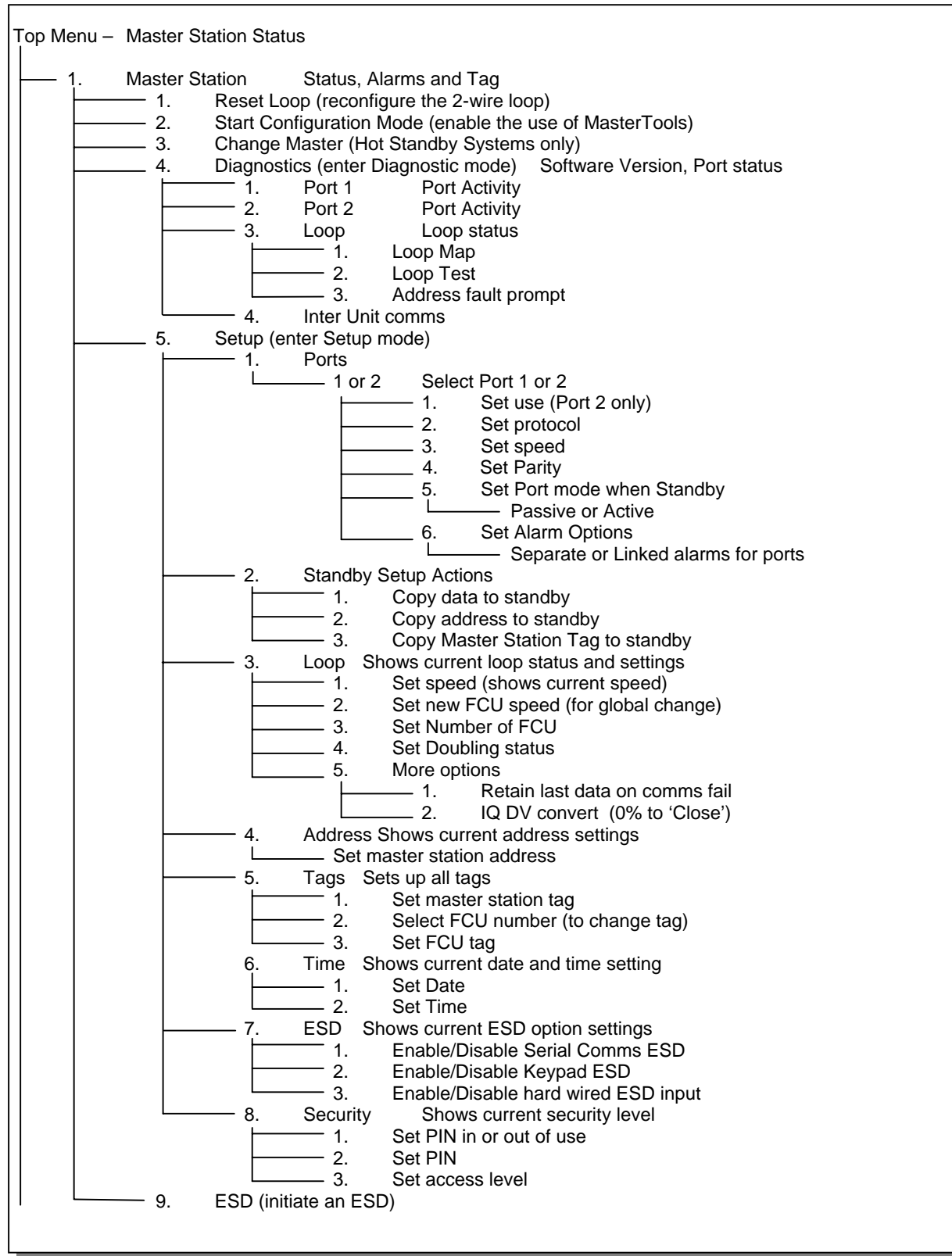

Fig 13: Master Station Functional Menu Structure

Menu pages are reached by using the number keys on the control pad. Commands and settings of the system require that the correct security level is chosen and, when selected, the PIN is entered. All commands must be verified by the **LOAD** key and may be cancelled by the **CLEAR** key. The **MENU** key always returns to a higher level in the structure.



Top Menu – Master Station Status

2. Field Units Shows status of selected field unit

For non IQ Actuators -

- 1. Open command
- 2. Close command
- 3. Stop command
- 4. Set Desired Value output
- 5. Block and Parameter screen
- 9. Alarms text
 - 1. Next alarm (if there is one)

For General Purpose FCU

- 1. Show relay output status
 - 1. Control relay 1
 - 2. Control relay 2
 - 3. Control relay 3
 - 4. Control relay 4
 - 5. Set analogue output
 - 6. Block and Parameter screen
- 9. Alarms text
 - 1. Next alarm (if there is one)

For IQ Analogue field unit

- 1. Go to Block and Parameter screen
- 9. Alarms text
 - 1. Next alarm (if there is one)

For IQ Actuators

- 1. Open command
- 2. Close command
- 3. Stop command
- 4. Set Desired Value output
- 5. IQ secondary status (Aux Inputs)
 - 1. IQ Opening Torque display
 - 1. IQ Closing Torque display
 - 2. Reload opening torque
 - 3. Block and Parameter screen
 - 2. Block and Parameter screen
- 9. Alarms text
 - 1. Next alarm (if there is one)

For devices not communicating

- 5. Block and Parameter screen

- 1. FCU number
- 2. Block select
- 3. Parameter select

9. Alarm Data (full text alarm message – only visible if an alarm is present)

8.5 Master Station Status

Master tag	Master	MSTAG001
Status	Status=LB OFF	ESD
Alarms	9>Alarms=P	
Options	1>M/S	2>Field Units

This is the first master station screen that is displayed at power-up

The Master Tag is an identity tag that can be configured by the user.

The Status line indicates the loopback status and the ESD input state. The loopback state is displayed as:

- LB OFF** - loopbacks are all off
- LB ON** - loopbacks are in use, i.e. there is a loop fault
- LB busy** - this message appears during loop re-configuration and is one of the following;
 1. LBbusy: Wait for LB 1 (first wait for loopbacks to come on)
 2. LBbusy: Find FCU's on A (finding FCU's on port A)
 3. LBbusy: Test Loop (testing for complete loop)
 4. LBbusy: Find FCU's on B (finding FCU's on port B)
 5. LBbusy: Wait for LB 2 (second wait for loopbacks to come on)
 6. LBbusy: LBs off on A (removing loopbacks from port A)
 7. LBbusy: LBs off on B (removing loopbacks from port B)

(The normal sequence for a fault free loop would be 1, 2 and 3. A sequence for a break in the loop anywhere except at port A or port B, would be 1 to 7. Some of the phases may be very quick, particularly at higher baud rates, and so may not be displayed as the LCD update rate is about twice a second.)

- ESD** - master station in ESD mode, e.g. ESD link broken

The Alarms line shows master station alarms by means of code letters:

- F** - Memory failure
- B** - Low battery
- P** - Power on reset
- A** - Field unit address fault
- auto LB** - Automatic loopback occurred

☐ Commands available:

- CLEAR** - Accept alarms
- 1** - Go to master station menu
- 2** - Go to field unit status page
- 9** - Go to alarm detail page (displays full text of system alarms present)

8.5.1 Master Station Commands

```
1>Reset Loop   9>ESD
2>Start Config Mode
3>Change Master
4>Diagnostic 5>Setup
```

This screen provides commands and options for the master station itself. The PIN number may require to be entered before some functions are permitted. Config Mode forces the selected serial port to a fixed setup so that MasterTools utility can communicate via that port. The RS232/RS485 settings must be made independently. (MasterTools is the Rotork supplied utility used to read and write setup and tag data with a PC.)

□ Commands available:

- 1** - Command to re-configure loop. This should be used after a loop fault has been corrected
- 2** - Start or stop Configuration Mode. A port selection screen appears to set the comms port to use with the MasterTools utility.
- 3** - (Hot Standby systems only) Relinquish control and allow the other unit to take over.
- 4** - Go to diagnostic menu
- 5** - Go to setup menu
- 9** - Send ESD command to all field units. This option is only displayed if the Keypad ESD has been enabled.
- MENU** - Return to previous menu

After pressing either of the command keys 1, 3 or 9, a confirmation message screen appears asking whether you wish to send the command (e.g. after pressing 1, the Reset Loop key, the following will appear)

```
Reset Loop Command
LOAD to confirm
CLEAR to cancel
```

- LOAD** - Confirms the command previously selected and executes it.
- CLEAR** - Cancels the command previously selected.

8.5.2 Master Station Alarms - Text Description

Number of system alarms	1 System Alarms
Alarm description	Power up Reset
View the next alarm	1>Next Alarm

This page gives an English text description of the master station alarms that appear as single letters on the Master Station Status screen.

The first line shows how many unacknowledged or current master station alarms there are.

The third line gives a full text description of each alarm in turn.

Pressing “1” displays the text string for the next alarm. Pressing “1” on the last alarm, brings up the first alarm.

The following table shows the text displayed for each of the letter codes,

Letter	Alarm Text
F	Memory failure
A	Address fault
P	Power up reset
W	Watchdog reset
B	Battery low
Auto LB	Auto loopback

□ Commands available:

- 1** - View next alarm text description
- MENU** - Return to previous menu
- CLEAR** - Cancels the command previously selected.

8.6 Configuration Mode Screen

```
Select Port for
Upload and Download:
1>Port 1
2>Port 2
```

This mode forces the selected port to adopt speed, protocol and address parameters that match the settings needed for the MasterTools utility. MasterTools runs on a PC and allows the master station settings to be modified using a PC screen and keyboard. In addition MasterTools will record all the settings present and those of the attached field units. Tags for all devices can be set with the utility.

Select the port to use bearing in mind that the PC probably requires RS232 communications. The hardware connection to the master station must still match the PC. This means that for direct communication Port 2 (the RS232 port) should be used.

❑ Commands available:

- 1** - Selects Port 1
- 2** - Selects Port 2
- MENU** - Return to previous menu

Once selected the screen changes to that below (shown with Port 2 selected) and the port adopts the settings shown irrespective of the configured settings.

```
Select Port for
Upload and Download:
Port 2 Config Mode
9600, odd Par, Addr1
```

When Configuration Mode has been finished with select Menu to return to the main menu. The master station will reload the original or newly set configured values for the port's settings.

❑ Commands available:

- MENU** - Return to previous menu

8.7 Diagnostic Menus

8.7.1 Top Diagnostic Display

Software version	S/W: 0124 V5. 8/V5. 2
Port 1 activity	1>Port 1 Rx Tx
Port 2 activity	2>Port 2 Rx Tx
Loop diagnostics	3>Loop 1 x2 >4 Inter-unit comms

The top line shows the code for the software type fitted and its version numbers:

011X	-	single master station
012X	-	hot standby master station
01X1	-	60 channel unit
01X2	-	120 channel unit
01X3	-	180 channel unit
01X4	-	240 channel unit
		(X means doesn't matter)
V5.8/V5.2	-	V25 card software version, (5206-014) and loop driver software version, (5206-034)

The port activity flags flash to indicate when a message is received (Rx), or when a reply is transmitted (Tx).

The centre of the fourth line contains a number that indicates loop activity and the field unit that is currently passing data to the master station (0 or 255 may be shown when no data is being passed), The message 'x2' indicates when the loop is running at double speed. Inter-unit communications applies to hot standby systems only and is information about the data exchange between the two units in the hot standby pair.

□ Commands available:

1	-	Go to Port 1 diagnostic page
2	-	Go to Port 2 diagnostic page
3	-	Go to Loop diagnostic page
4	-	Go to Inter-unit comms page (hot standby systems only)
MENU	-	Return to previous menu

8.7.2 Modbus Port Diagnostic Displays

Port number	1	msg	err	xcpt	crc
Message counts	123	0	0	0	0
	Mod	func	addr	data	
Last message details	1	2	1920	48	

The illustration shows the diagnostic display for Port 1, the display for Port 2 is similar.

These screens give detailed diagnostic information for the serial links; the Port number is shown on the top line. The top half displays numerical count for various message types since the last time the display was reset (cleared to 0):

- msg** - number of valid messages received
- err** - number of errors, e.g. overrun errors, parity errors, Baud rate errors
- xcpt** - number of Modbus exception responses generated
- crc** - number of messages received with incorrect CRC's

The bottom half shows details of the last message received, (the address and data in decimal format):

- Mod** - the Modbus address of the last request
- func** - the Modbus function code of the last request
- addr** - the discrete bit or register number in the last request
- data** - the data field of the last request, typically the number of points or registers

Some familiarity with the protocol is needed to make use of this display. Its purpose is help in commissioning a serial communications link to a Host computer by making the master station show the received data as it interpreted it. By referring to the protocol specification the validity of the messages can be checked. The display is normally 'frozen' and is only updated when a key is pressed (any key except the Menu key). This gives time to take note of the numbers. Most Host systems are set up to send out a short sequence of requests for data, and by pressing a key a few times it is possible to capture all the messages. The "Clear" key resets the counters on the top half of the screen.

□ Commands available:

- CLEAR** - Zeros the message and error counts
- LOAD** - Or any other key except Clear or Menu updates display with the last message
- MENU** - Return to previous menu

8.7.3 Printer port diagnostic display

Port number	1	len	pin	pout	err
Print queue		1	0	0	0

The master station port 2 supports a serial (RS232) printer or similar generic device. If Port 2 is set for Printer use then the diagnostic display will be changed from that shown in section 8.7.2 Modbus Port Diagnostic Displays to the one shown above.

The screen shows the following data:

- len** - number messages queued up to be printed
- pin** - printer queue input pointer
- pout** - printer queue output pointer
- err** - number of overflow errors, (indicated the master station buffer is full)

□ Commands available:

- MENU** - Return to previous menu

8.7.4 Loop Diagnostic Display

Reason for loop configuration	Loop: Fault Found
Fault Found	Loop open circuit
Address of fault details	Loopbacks at 4 5
FCU map/Test/Address fault	1>Map 2>Test 3>Addr

This screen provides information to aid in commissioning and fault finding on the current loop. Additional screens below this one also contain useful data on the loop status and connected field units.

The first line gives the Reason message and shows the reason why the loop was last re-configured. The message will be one of the following:

Power on Reset	- loop configured because the master station powered up
Fault Found	- fault detected on the loop whilst it was running without loopbacks present
Fault Found A	- fault detected on the A side of broken loop whilst running with loopbacks on
Fault Found B	- fault detected on the B side of broken loop whilst running with loopbacks on
Reset Command	- loop Reconfigure command entered from keypad or serial port
Return wire fault	- fault detected in the return current path whilst the loop was running at double speed
Doubling failed	- fault detected after loop assumed double speed.

If a fault occurs, the Fault Found message will be one of the following:

Zero Address	- a field unit has been found with an address of zero
Address too High xx	- a field unit has been found with an address higher than that setup within the master station, xx is the address
Same Address xx	- two field units found with the same address, xx is the address
Loop Open Circuit	- an open circuit fault found on the loop
Loop Short Circuit	- a short circuit fault found on the loop

Note: In the case of address faults, the master station will continue to operate the loop, missing out the faulty field units. The fault details can be found with command 3.

If a fault occurs the message on the third line will be:

Position xx	- xx is the position from A of zero address or address too high
Positions xx yy	- xx and yy are the positions from A of the duplicate addresses
Loopbacks at xx yy	- cable fault lies between xx and yy

If there are no loop faults then lines 2 and 3 will be blank. If there is more than one loop fault the display shows the first one detected.

❑ **Commands available:**

- 1** - Go to FCU map screen
- 2** - Loop speed test (only possible if loop is complete)
- 3** - Field Unit address fault details (only available if an address fault is present)
- MENU** - Return to previous menu

8.7.4.1 FCU Map and Failure Counts

Physical position	Loop Position = 72	
Address	FCU Address = 17	
Attached port	Port=A Fails = 5	Comms fail count
Field unit type	Type=Act S/W = 2.07	Software version

The screen displays information about field units found on the loop during loop configuration.

The top line shows the physical position on the loop, the second line the address of the field unit found at that position, and the third line the master station port it is attached to. For a complete loop with no loopbacks, all the field units are attached to port A.

The third line also shows a count of communication errors with the field unit whose address is displayed above. The count has a range of 0 to 255, after which it rolls around to zero. The counter increments for every communication error though the system will only announce a 'Comms failure' when 3 successive tries have failed to locate the field unit. This counter therefore reflects the communications condition and can be used as an indicator of the health of the field unit to assess the probability of failure in the future.



The bottom line shows the type of field unit and the software version of the EPROM. "Type" can be displayed as:

Act	- Non - IQ Actuator
IQ	- IQ or IQT Actuator
GP	- General Purpose Field Unit
IQA	- IQ or IQT Analogue
PPk	- Flowpak actuator

Information for this screen is available approximately 30 seconds after loop configuration is complete and is updated approximately once a minute after that.

The example screen above shows that at loop position 72 there is field unit address 17, and it is attached to port A, that it is an actuator field unit with software version 2.07 and that 5 communications failures have been recorded for it since the system was last reset.

□ Commands available:

	-	Move to the next field unit
	-	Move back to previous field unit
	-	Return to previous menu

8.7.4.2 Loop Speed Test

Speed selection	1>Loop Speed = 1200
Perform test	2>Test
Test result	Result 100%

This screen allows the user to cause test messages to be sent around the loop at a defined baud rate. After each test the loop returns to normal speed so that the interruption to FCU communications is minimal. (The loop speed test should be done at speeds higher than the loop is currently running at). The result of the test is displayed as a percentage success rate so that the user may have a degree of confidence in the performance with the loop speed chosen.

❑ Commands available

- 1** - Select the test speed, pressing '1' will scroll through the speed options
- 2** - Perform test. This causes a test message to be sent around the loop 10 times
- MENU** - Return to previous menu

The loop speed options are 300, 450, 600, 900, 1200, 1800, 2400, 3600, 4800, and 7200. Some of these speeds cannot be selected for normal use, however they do provide information about the performance margin available.

8.7.4.3 FCU Address Fault Details

```
FCU Address Fault
Duplicate Address
Address 10
  15 on A & 139 on B
```

This screen shows details of any address fault present on the loop.

Line 2 shows the type of fault. Possible messages are

Duplicate address	- More than one field unit with the same address
Address too High	- A field unit has an address higher than the set address to scan up to
Zero Address	- A field unit has address zero (not permitted)

Line 3 shows the offending address.

Line 4 shows the position of the offending address or addresses. The above example indicates that a field unit at address 10 was found at position 15 out of port A and at position 139 out of port B. The display can show only two positions. If the same address occurs 3 or more times on the loop only the first two will be shown.

If there is more than one address fault on the loop this display will show the last one found.

The FCU map will always show the complete picture, i.e. every FCU found during loop configuration, including duplicates, however many FCU there are.

□ **Commands available:**

MENU - Return to previous menu

8.7.5 Hot Standby Inter Unit Diagnostic Display

```

Inter-Unit Comms
Clock OK   Data OK
Watchdog Lo
T 0 C 0 R 1 L 0
    
```

This screen gives information about the communications between the two units that make up a hot standby pair. It is intended mainly as an aid to testing and fault diagnosis.

The signals Clock, Data and Watchdog are interconnected between the two units with each side having its own set. In normal operation the screens on the two units differ and will show:

Signal	Main Unit	Standby Unit
Clock	OK	OK
Data	Hi or Lo	OK
Watchdog	Hi or Lo	OK

The signals may transiently change to other values. In addition they will show as below if there is a fault on the unit.

Signal status	Condition
OK	The signal is good
Hi	The signal is stuck at logic '1'
Lo	The signal is stuck at logic '0'
Err	The signal is faulty

The last line shows the cumulative counts for 4 important errors. The value can be reset to 0 with the Clear key. The counters record the data on the side viewed. The sending (Main) side resends messages if it does not receive a response within the Timeout period. After 2 retries (3 attempts) it gives up and increments the Limit counter. On system operating normally the counter incremental rate should be small.

- T** - Number of Timeouts
- C** - Number of Checksum errors
- R** - Number of Retries
- L** - Number of times retry Limit reached

□ Commands available:

- CLEAR** - Zeros the error counts
- MENU** - Return to previous menu

8.8 Setup Menu

Note: The Setup options can be PIN protected. See sections 8.3 and 8.8.9

8.8.1 Top Setup Menu

Port setup	1>Ports	2>Standby	Only shows on hot standby units
Loop options	3>Loop	4>Address	Unit addresses
Set tag names	5>Tags	6>Time	Date and time
ESD options	7>ESD	8>Security	Access level settings

Note: When the Ethernet connections are being used the port settings are critical. See section 12.

□ Commands available:

- 1** - Go to Port 1 setup page
- 2** - Go to Standby mode menu page
- 3** - Go to Loop options page
- 4** - Change unit address used in communications with host computers,
- 5** - Go to FCU Tag names page
- 6** - Go to Date and Time setup page
- 7** - Go to ESD configuration page
- 8** - Go to Access level and security page
- MENU** - Return to previous menu

8.8.2 Port Setup Menus

```

1>Port 1
2>Port 2
    
```

The first screen allows the port to be set up to be selected, press 1 or 2 for port 1 or 2. Press Menu to return to the previous menu. Once selected a screen similar to the following is revealed.

Port use	1>P1 Use =Host	
Protocol	2>Generic Modbus	
Baud rate	3>19200	4>Par=Odd
Comms mode when standby	5>Standby Passive	6>
		Parity
		More options

For Port 1 (always RS485) the 'Use' option is restricted to host communication only, whilst Port 2 (always RS232) can be used either for host communication or to operate a serial printer.

Standby Passive or Active

Option 5 is only available on hot standby systems. It is used to set the mode of operation for the port when the master station (side A and B) is in standby mode. This is usually set to Standby Passive preventing the port from generating replies to data requests. If it is set to Standby Active then, when this module (side A or B) is the standby unit the port will remain active and generate responses. The appropriate setting of this option depends on how the serial communications to the host are organised. Note that the ports on a master station in Main mode (side A or B) are always active.

□ Commands available:

- 1** - Step around available options, fixed as Host for Port 1, selectable Host or Printer for Port 2
- 2** - Step round the available host communication protocol databases (always Modbus RTU half duplex, asynchronous communications)
- 3** - Step round the baud rate options for the port. Choices are 19200, 9600, 4800 and 2400
- 4** - Step round parity options. These are Odd, Even, None or '0' (always set to zero). Both ports have 1 stop bit and 8 bits/character
- 5** - Toggle between Passive (normal) and Active (hot standby systems only)
- 6** - Go to alarm linkage screen
- MENU** - Return to previous menu

8.8.2.1 Alarm Linkage

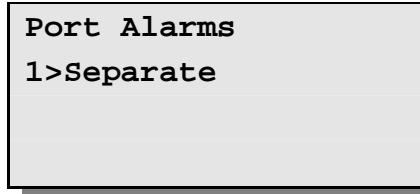

This screen allows port alarm handling to be configured. Alarms can either operate completely independently ('separate') for each port, or can be linked such that the same alarm information is always reported regardless of which serial port is used.



Alarms must be read and accepted before they can clear and return to normal. If configured as separate, alarm reading and acceptance must be done separately for each of the two ports. This ensures that the different hosts see all the alarms. When the alarms are linked, accepting an alarm on one port accepts the alarm on all the other ports as well.

The status screen displays for alarm indication cannot be linked to the serial communications alarm handling.

Linking the port alarm operations is useful in dual redundant serial link configurations between the master station and the host computer. When Ethernet communication is being used on hot standby systems the normal setting should be 'Linked'.

Note: Linking links both host serial port alarm handling together. The default option is Separate

□ Commands available:

-  - Toggle between "Linked" and "Separate".
-  - Return to previous menu

8.8.3 Data transfer to Standby Unit

1>Copy to Standby ON	Copy data to standby unit
2>Copy address ON	Copy master station address
3>Copy M/S tag ON	Copy master station tag

This page displays the “copy to standby” options and their current settings. This option is only available on hot standby master stations and allows data to be automatically transferred from the main unit to the standby unit. The default setting for all three options is “ON”.

❑ Commands available:

- 1** - Copy all settings from the main to standby unit except those listed below
- 2** - Copy the master station Modbus address from main to standby unit.
- 3** - Copy the master station tag from main to standby unit.
- MENU** - Return to previous menu

8.8.4 Loop Setup Menu

	1>Speed (now) = 1200	Current speed
	2>Speed (new) = 600	Desired speed
	3>Number FCUs = 69	Highest address
Doubling enable	4>Doubling - OFF	5>
		More options

This page displays and controls the options affecting the current loop.

The master station can program the speed used on the loop. Select the desired speed and it will be reprogrammed into the field units immediately the loop is next reconfigured.

The 'Doubling Enable' allows loop speed doubling to be enabled (ON) or disabled (OFF). If enabled, the master station automatically doubles the loop baud rate provided that it finds the loop is complete. This improves the scan time. In a few cases it may be necessary to disable this feature if it causes a high error rate on the loop.

□ Commands available:

- 1 - Step round the loop baud rate options. Choices are 110, 300, 600, 1200, and 2400.
- 2 - Step round the desired loop baud rate options. It is possible to select rates in the range one step up or one step down from the current speed.
- 3 - Change the highest field unit address on the loop. The master station polls all field units up to this highest address. The scan time is minimised if polling is restricted to only those field units that may be present.
- 4 - Toggle between doubling enabled and disabled.
- 5 - Further options
- MENU - Return to previous menu

Note: The loop scan time is minimised by setting the highest number to scan up to (the highest address). All the addresses in the selected range should be used and gaps in the address range should be avoided. Gaps or unused addresses cause the system to run more slowly as the unused addresses are still checked. In addition unused addresses will generate a communication failure alarm.

8.8.4.1 Further Loop Options

```
1>Retain data on
    Comms fail =OFF
2>IQ DV Convert=OFF
```

Two further settings for the data on the loop can be made from this screen.

There is an option to make the data held in the Modbus database for each FCU retain the last value obtained prior to loss of communication with the field unit should this occur. Retaining the data (ON) has the effect of reporting the last known position of the valve. The alternate option (OFF) is that once communications is lost the data is cleared to all zeros. Clearing the data ensures that information cannot falsely report actuator position data. The default value is OFF.

The IQ DV Convert option can be used to ensure that 100% and 0% Desired Value outputs to the IQ actuators only is transformed into actions to make the actuator run to the fully open (100%) and fully closed (0%) positions. With IQ DV Convert set to ON, the command message is converted from a DV command to an Open or Close command. This is useful for positioning actuators where it is possible that the valve will not fully shut or open when moved by only a small amount. When used for tight shut off valves with analogue position control only the setting should be ON.

With IQ DV Convert set to OFF the DV command is not changed and the actuator positions to as near to 0 and 100% as the deadband setting allows. If Limited Range Positioning is being used the setting must be OFF. The default is OFF.

□ Commands available:

- 1** - Toggle Retain Last Data setting
- 2** - Toggle IQ DV Convert option
- MENU** - Return to previous menu

8.8.5 Unit Address Setup Menu



The master station responds to messages directed at the Modbus slave address set using this page.

Note that in some cases when using Pakscan Generic Modbus protocol settings the master station will respond to more than one address, and the setting here is the Base address. There is more information on the base address and offset addresses in the Pakscan Modbus Protocol document (S171E). Valid Modbus addresses are from 1 to 247 inclusive.

□ Commands available:

- 1** - Set up the Pakscan data Modbus address
- MENU** - Return to previous menu

8.8.6 Tag Setup Menu

Master station tag	1>M/S Tag	MSTAG001
FCU address	2>FCU =	2
FCU's tag	3> Tag	FCUTAG02

This is the page for editing tag names that may be assigned to the master station and the field units.

□ Commands available:

- 1** - Edit master station's tag
- 2** - Change field unit address
- 3** - Edit field unit tag
- ↑** - Go on to next FCU
- ↓** - Go back to previous FCU
- MENU** - Return to previous menu

Editing a tag:

An arrow appears beneath the character being edited

MSTAG001

^

□ Commands available:

- ↑** - The Up and Down arrow keys are used to scroll through the characters which can be used in tag names. These are: 'A' to 'Z', '0' to '9', plus '-', and 'Space'. (Numbers 0 to 9 can however, be entered directly via the keypad)
- ↓**
- CLEAR** - Abandon editing and start again
- LOAD** - Accept current character and move onto the next one
- MENU** - Finish editing

8.8.7 Date and Time Setup

Date	1>Date 25/10/ 5
Time	2>Time 19:32:00

This page shows the state of the internal real-time clock. It is used to tag printer alarm messages with the time at which the alarm occurred and email messages from the Pakscan Ethernet alarm function when they are sent.

The date is displayed in the form Day/Month/Year.

The time is displayed in the form Hours:Minutes:Seconds using a 24 hour clock.

□ Commands available:

- | | | |
|------|---|-------------------------|
| 1 | - | Set date |
| 2 | - | Set time |
| MENU | - | Return to previous menu |

Setting the date:

On pressing '1', the 'Day' field is cleared and you can type in a new day. Correct a mistake by pressing the 'CLEAR' key. Finish entering the new day by pressing 'LOAD'. The 'Month' field will then be cleared, and so on.

Setting the time:

This is similar to setting the date.

8.8.8 ESD Options Setup Menu

```
ESD Options
1>Serial Disabled
2>Keypad Disabled
3>Input Disabled
```

This page allows the user to select the ESD (emergency shutdown) function. ESD operation can be enabled or disabled separately for the serial ports, the keypad, and the hardware input. The default setting for all three controls is all inputs disabled.

❑ **Commands available:**

- 1** - Enables / disables host port ESD input
- 2** - Enables / disables keypad ESD input
- 3** - Enables / disables hard wired ESD input, (terminals 32 and 33)
- MENU** - Return to previous menu

Note: A hard wired input ESD will cause a shutdown action when the contact input is open circuit. The individual actuator function on receipt of the ESD command is set within the actuator itself. Valves may close, open or stay put during an ESD event.

Once an ESD command has been issued to the actuator field units, local control is not available until a new command is sent from the master station to each actuator. The new command may be open, close or stop.

8.8.9 Keypad Security Options

```

Keypad Security
1>PIN In Use
2>PIN = ****
3>Access Level 3

```

A security code, PIN, can be set up to prevent unauthorised changes to the master station settings or field unit outputs. Line two shows '**PIN Not In Use**' if no PIN has been set up and '**PIN In Use**' once a PIN has been set.

The 'Access Level' number on line 3 indicates the operations that are protected by the PIN. The meaning of these numbers is:

- ❑ **Access level:**
 - 1 - No protection. Setup can be changed and keypad commands entered without the PIN.
 - 2 - Setup protection. Setup changes require the PIN but keypad commands do not.
 - 3 - Setup and Command protection. Both setup changes and keypad commands require the PIN.
 - 4 - No keypad commands permitted whilst any host serial communication line is active. [If all serial communication links are inactive for 5 seconds then keypad commands can be entered provided the PIN is entered (as with level 3).]

- ❑ **Commands available:**

(All changes require either the Access level to be set to 1 or the current PIN to be entered)

- 1 - Change the requirement for inputting a PIN. When setting the PIN as 'Out of use' the previously programmed PIN is lost
- 2 - Enter a new PIN (when entered it will automatically place PIN 'In use'). Key in the PIN required. Numbers between 1000 and 9999 are acceptable. Mistakes can be corrected using the CLEAR key. Finish entering the PIN by pressing LOAD. (The shipping default is 1000).
- 3 - Change the access level
- MENU - Return to previous menu

- ❑ **Entering a PIN from any screen:**

- * - Pressing the * key reveals the PIN entry screen. Type in the PIN and then press the LOAD key. If the PIN is correct then press the MENU key to return to the previous page.

When an action requires the PIN to be entered a screen message 'PIN required' is displayed.

8.9 Field Unit Menus

The master station displays a screen appropriate to the type of field unit.

8.9.1 Actuator Field Unit Status Display

Digital status	OA1 ST0 MO0 FCUTAG01	Tag name
Digital status	CA0 MR0 MC0 1	FCU address
Measured value (position)	MV=100% 9>Alms=P	Alarm status
FCU commands	1>O 2>C 3>S 4>DV 5>	More options

Digital Status key:

(The display shows a '0' if the state is false and a '1' if it is true)

- | | |
|--|-----------------------------------|
| OA - Open Limit Switch | CA - Close Limit Switch |
| MO - Running Open | MC - Running Closed |
| MR - Motor Running | ST - Stopped in mid-travel |
| LB - appears if field unit is in loopback | |



Alarms key:

(The letter is present if the alarm has occurred)

- | | |
|-----------------------------------|---|
| F - FCU memory failure | j - Valve jammed |
| P - Power on reset | o - Valve obstructed |
| C - Communications failure | e - Motor running at end of travel |
| W - Watchdog reset | m - Manual operation |
| r - Monitor relay | s - Start/Stop failure |
| l - Local stop pressed | a - Auxiliary override alarm (IQ only) |
| c - Control Not Available | x - Travel time exceeded (IQ only) |
| t - Thermostat tripped | |

Commands available:

- | | |
|-------------|---|
| 1 | - Send Open command |
| 2 | - Send Close command |
| 3 | - Send Stop command |
| 4 | - Send Set DV command. The master station prompts for the new DV before sending the command |
| 5 | - Go to secondary data page |
| 9 | - Go to alarm detail page (full text details of field unit alarms) |
| MENU | - Return to previous menu |

	The Up and Down arrow keys are used to scroll through the field units
	
	CLEAR - Accept alarms





Note: When the Access Level is set to 3 or 4, to issue a command the correct PIN must be entered first. Pressing command keys 1, 2, 3, or 4 causes a confirmation screen to appear before the command is sent.

8.9.1.1 IQ Actuator Second Status Page

Current torque	Torq=85%	FCUTAG01	Tag name	
Auxiliary inputs	Aux1=1	Aux2=0	1	FCU address
	Aux3=0	Aux4=0	LoBat	Battery status
	1>Torque	2>		More options

This screen only appears for IQ and similar actuators, it shows the current torque value and the status of the 4 auxiliary digital inputs on an IQ actuator. The flag "LoBat" is displayed if the field unit is reporting that the battery within the actuator is low.

☐ **Commands available:**

	-	Go to next field unit
	-	Go to previous field unit
	-	Go to torque display screen
	-	Go to secondary data page
	-	Return to previous menu

8.9.1.2 IQ and IQT Historic Torque Displays

Open Torq FCUTAG01				
101	83	74	62	1
59	67	81	98	<Open
1>	Close	2>	Reload	3>

Close Torq FCUTAG01				
96	85	70	58	1
57	65	78	92	<Open
1>	Open	2>	Reload	3>







These screens show 8 values of torque for the actuator travelling in the opening or closing direction. They are the values that have been most recently received from the field unit. The 8 values refer to the actuator motor torque at the following positions of the actuators stroke, 6%, 19%, 31%, 44%, 56%, 69%, 81% and 94%. Thus on the "Open Torque" example screen shown above, 101% is the torque value at 6% open, 83% is the torque value at 19% open, etc.

Torque values are displayed as percent of rated torque and have a range of 0 to 120%.

Note: If the actuator has been moved over part of its stroke, e.g. from 20% to 60% open, then the torque values outside that range may have been reset to zero.

If the IQ field unit has been programmed with a torque filter factor of "000" then these 8 torque values are automatically returned to the master station once the actuator has travelled from one end of travel to the other. However, if the filter factor has been set to a value greater than "000" these values are only returned when the reload button (2) is pressed. Pressing reload will also cause the master station to fetch the torque values when the actuator has not travelled from end to end, irrespective of filter factor setting. If the actuator is not an IQ, but uses an IQ actuator field unit these pages will appear, but will not be populated with data.

☐ **Commands available:**

-  - Go to next field unit
-  - Go to previous field unit
-  - Toggle between opening and closing torque screens
-  - Reload new torque values
-  - Go to secondary data page
-  - Return to previous menu

8.9.2 Flowpak Actuator Field Unit Status Display

Digital status	OS1 ST0 TO0 FCUTAG01	Tag name
Digital status	CS0 TR0 TC0 1	FCU address
Measured value (position)	MV=100% 9>Alms=P	Alarm status
FCU commands	1>O 2>C 3>S 4>DV 5>	More options

❑ **Digital Status key:**

(The display shows a '0' if the state is false and a '1' if it is true)



OS - Open Limit Switch	ST - Stopped in mid-travel
TO - Travelling Open	CS - Close Limit Switch
TR - Valve Travelling	TC - Travelling Closed
LB - appears if field unit is in loopback	

❑ **Alarms key:**

(The letter is present if the alarm has occurred)

F - FCU memory failure	j - Valve jammed
P - Power on reset	o - Valve obstructed
C - Communications failure	l - Local stop pressed
W - Watchdog reset	r - Monitor relay
s - Start/Stop failure	t - Low pressure
m - Manual operation	c - Control Not Available

❑ **Commands available:**

1	- Send Open command	 The Up and Down arrow keys are used to scroll through the field units   CLEAR - Accept alarms
2	- Send Close command	
3	- Send Stop command	
4	- Send Set DV command. The master station prompts for the new DV before sending the command	
5	- Go to secondary data page	
9	- Go to alarm detail page (full text details of field unit alarms)	
MENU	- Return to previous menu	

Note: When the Access Level is set to 3 or 4, to issue a command the correct PIN must be entered first. Pressing command keys 1, 2, 3, or 4 causes a confirmation screen to appear before the command is sent.

8.9.3 General Purpose Field Unit Status Display

	DIN1->DIN8	FCUTAG01	Tag name
Digital inputs	00001111	1	FCU address
Measured value 1	A1= 75% 9>Alms=P		Alarms
Measured value 2	A2= 50%	1>More	Commands page

The status of the eight digital inputs is displayed as eight 0's or 1's. A 1 indicates that the input is true.

The alarms code letters are the same as for an actuator field unit. However, only memory failure (F), comms failure (C), power on reset (P) and watchdog timer (W) are valid alarms. As with the actuator page there is a full text display of the alarms that may be found by pressing 9.

- ❑ **Alarms key:**
 (The letter is present if the alarm has occurred)
F - FCU memory failure
P - Power on reset
C - Communications failure
W - Watchdog reset

The commands are accessed by going to a second page (press 1). This is because there is more data than for an actuator field unit.

- ❑ **Commands available:**

- 1 - Go to commands page
- 9 - Go to alarm detail page (full text details of field unit alarms)
- MENU - Return to previous menu

- ↑ The Up and Down arrow keys are used to scroll through the field units
- ↓
- CLEAR CLEAR - Accept alarms

8.9.3.1 Second Page for General Purpose Field Unit

Pulse counter	Pulses= 44 FCUTAG01	Tag name
Relay commands	1>R1=0 2>R2=0 1	FCU address
	3>R3=0 4>R4=0	
Analogue output	5>Aout= 0% 6>	Block and parameter screen

Digital input 1 on a GPFCU can be used as a pulse counter. The master station screen will count pulses up to 9999 before rolling over to 0 and starting again.

Options 1 to 4 prompt the user to Energise (1) or De-energise (0) the relay before the command is sent.

Note: The general Purpose Field Unit may be configured for fleeting relay outputs, in which case it will not action the de-energise commands, and if the relays are energised their status will always display 0.

Option 5 prompts the user to enter a data value for the analogue output in the range 0 to 100 %.

□ Commands available:

↑	-	Go to next field unit
↓	-	Go to previous field unit
1	-	Operate relay 1
2	-	Operate relay 2
3	-	Operate relay 3
4	-	Operate relay 4
5	-	Set analogue output
6	-	Go to secondary data page
MENU	-	Return to previous menu

Note: When the Access Level is set to 3 or 4, to issue a command the correct PIN must be entered first. Pressing command keys 1, 2, 3, or 4 causes a confirmation screen to appear before the command is sent.

8.9.4 IQ Analogue Input Field Unit

Analogue input channel 1	A1= 12%	FCUTAG01	Tag name
Analogue input channel 2	A2= 34%	1	FCU address
	9>Alms=P		Alarms
		5>	Block and parameter screen



The IQ actuator can contain two field units, each with their own loop address. The IQ Analogue Input field unit collects two analogue signals for display and reporting.

The alarms code letters are the same as for an actuator field unit. However, only memory failure (F), comms failure (C), power on reset (P) and watchdog timer (W) are valid alarms. As with the actuator page there is a full text display of the alarms that may be found by pressing 9.

- ❑ **Alarms key:**
(The letter is present if the alarm has occurred)
 - F** - FCU memory failure
 - P** - Power on reset
 - C** - Communications failure
 - W** - Watchdog reset

There are no commands associated with this page, though the block and parameter screen does allow access to the parameters associated with reporting.

- ❑ **Commands available:**
 - 5** - Go to secondary data page
 - 9** - Go to alarm detail page (full text details of field unit alarms)
 - MENU** - Return to previous menu

	The Up and Down arrow keys are used to scroll through the field units
	
	CLEAR - Accept alarms

8.9.5 Communications Failure Display

FCUTAG01	Tag name
1	FCU address
Alarm : Comms Fail	Alarm
5>	Block and parameter screen





This display is put up if the field unit is not in communication with the master station.

FCUTAG01	Tag name
1	FCU address
Alarm : Comms Fail	Alarm
(FCU Fault) 5>	Block and parameter screen

Address Fault

If the field unit has an address that is duplicated, the additional line FCU Fault is also indicated.

□ Commands available:

	-	Go to next field unit
	-	Go to previous field unit
	-	Go to secondary data page
	-	Return to previous menu

8.9.6 Field Unit Status Secondary Data

Block	1>Block= 5 FCUTAG01	Tag name
Parameter	2>Para = 2 1	FCU address
Data	3>Data = 16	
Name	Motion Inhibit Timer	

This page allows the user to read and change parameters in a field unit. Data in field units is organised into 32 blocks each of 8 parameters, the parameters within each block being related to each other, e.g. block 5 contains parameters which are connected with the position control mechanism of an actuator.







Parameters are selected by setting the appropriate block and parameter numbers. The parameter name and its current value are then displayed. Values are displayed and entered as decimal numbers.

On entry of a parameter number the master station will send a message to the field unit to read the required data, which will then be displayed.

On entry of new parameter data in a valid parameter, the master station will write that data to the field unit. The master station does not check whether the data is valid, only that the parameter may be written to. After writing, the master station will read back the parameter. Writes to Block 1, and to Parameter 0 of any Block, are not permitted from the master station.

Refer to S171E: Pakscan Master Station Modbus Interface Specification for Communication via RS232 or RS485 for field unit data allocation information and details of the meaning of each parameter.

□ Commands available:

-  - Go to next field unit
-  - Go to previous field unit
-  - Enter block number, numbers between 0 and 14 are valid
-  - Enter parameter number, numbers between 0 and 7 are valid
-  - Enter new parameter data (in decimal)
-  - Return to previous menu

 Press LOAD after entering a new value to complete the action and update the screen.

8.9.7 Field Unit Alarm – Text Description

Number of alarms	3 Alarms	FCUTAG01	Tag name
		1	FCU address
Alarm description	Power up Reset		Alarm
View the next alarm	1>Next Alarm		

This page gives an English text description of the FCU alarms that appear as single letters on the FCU status display screen.

The first line shows how many unacknowledged or current FCU alarms there are.

The third line gives a full text description of each alarm in turn.

Pressing “1” displays the text string for the next alarm. Pressing “1” on the last alarm, brings up the first alarm.

The following table shows the text displayed for each of the letter codes;

Letter	Alarm text	Letter	Alarm text
F	Memory failure	t	Thermostat tripped
P	Power up reset	j	Valve jammed
C	Communication failure	o	Valve obstructed
W	Watchdog reset	s	Stop/start failure
c	Control not available	m	Motor running at end of travel
L	Local stop pressed	a	Auxiliary override alarm
r	Monitor relay	x	Valve travel time exceeded

□ Commands available:

1 - Go to secondary data page

MENU - Return to previous menu

CLEAR - Accept alarms

(This page is intentionally blank)

9 SETTING PARAMETERS

IMPORTANT SAFETY PRECAUTIONS

- If it is not possible to secure the connected equipment into a safe state then disconnecting the loop cable from both ports of the master station will prevent plant operation.
- When setting the parameters for a particular master station it is essential to protect any connected plant from inadvertent operation. Ensure that the connected actuators are in Local control (as this will prevent them from moving under Pakscan control EXCEPT for ESD - remember that ESD is latched in a field unit), or Local Stop is selected, or locked in 'Hand'. Also ensure that any other plant equipment connected to field units is either able to be operated safely, or is prevented from operating.
- On the master station ensure that the ESD option is either disabled or that the input is a closed circuit (by either a link or the actual input contact).
- These simple precautions will make sure that if a mistake is made in the setting of the master station parameters no plant action will result.
- The plant should only be returned to an operational state once it is certain that the parameters are correctly set or the programme operates correctly.

BEFORE COMMENCING

- Make sure that all the hardware selections match those required for the final equipment. Set all the jumper links and switches as required.
- Make sure the master station is powered up and the screen is illuminated.
- Changes to the internal parameter settings can only be made if the PIN is known or disabled or the Access level is low enough. (When the master station leaves Rotork its PIN protection level is disabled, however, it may have been enabled by a third party before arriving on site). Make sure that access is possible by knowing the PIN or knowing what PIN is to be set.

9.1 Initial Decisions

The setting up of the user variable parameters in a master station requires detailed knowledge of what the system is required to do and how it is to achieve it.

Answers to the following questions must be available:

- 2-wire loop**
For the 2-wire loop, how many field units are connected, or to be connected, and what is the highest address used for a field unit? What is the loop baud rate? Is it necessary to run the loop at its maximum performance?

- ❑ **Serial Host Communications (RS232 or RS485)**
Where applicable, for communication to the host system what Protocol will be used, what Baud rate is needed, what parity is needed? If there are two hosts this data is needed for both and also if the alarms data bases should be separate or linked.
- ❑ **Ethernet Host Communications**
Where applicable, what IP address is required for the master station? What is the Protocol that is to be used? The settings for Port 1 and Port 2 will also vary depending on the connection configuration of the Ethernet bridge module.

9.2 Serial Communication Ports

The master station may be configured for different functions on each of its two serial communication ports. However the Modbus address of the master station relates to all the ports, they cannot differ.

Setup	
Addresses	Host, Modbus Slave address
Comms Protocol	Generic Modbus Yokogawa Modbus Honeywell PLCG Modbus Honeywell SI Modbus
Baud Rate	2400, 4800, 9600, 19200
Parity	Odd, Even, None, always 0
Port Alarms	Linked, Separate

The settings to make are in the Master Station Setup Menu as described in section 8.8. To reach the required screens from the opening top menu screen, press '1' to select the master station side of the menu structure. The next screen revealed shows the options for what to do next. Press '5' to select Setup. Changes to the settings can only be made if the PIN is entered or the Access Level is set to 1, though the settings may be reviewed at any time. The next screen displayed is as shown in section 8.8.1 and this has under option 4 the ability to set the master station Modbus slave address.

Press '4', then '1' and enter the number to be used as the Modbus address, when it is correct press 'LOAD'. The screen is refreshed, shows the selected address and a message briefly appears informing you that the new setup is loaded. Return to the previous menu by pressing 'MENU'.

From the master station setup menu screen (8.8.1) press '1' to select Ports (8.8.2), then '1' to select port 1. The revealed screen shows the selectable options for Port 1.

Option 1 is fixed as host communication on this port.

Pressing '2' will scroll round the available protocols, select the required. Note that the Rotork PC based plant control package, InVision, uses the Generic Modbus setting and Ethernet uses Generic Modbus when the web browser is required.

Pressing '3' steps round the baud rates and '4' selects the parity.

When the settings are correct, press 'MENU' to return to the previous page. The chosen settings will only become active once you leave the 'set up' screen. Press '1' and then '2' to select Port 2.

The screen is very similar to the one for Port 1 except that Port 2 can be selected to operate a serial printer. Make the settings required in the same way as for Port 1.

Having set the port communications parameters it is then necessary to set the alarm linkage if both comms connections to a single host are being used, or an Ethernet bridge linked to both ports is being used. Press '6' to gain access to the screen shown in section 8.8.2.1. Linked alarms will operate such that accepting an alarm using comm port 1 will also cause it to be accepted in the data base serving comm port 2 (and similarly for comm port 2, it will accept alarms on port 1). If the host system is using redundant serial communications with two links to one host then the option should be set to 'Linked'. If two or more independent hosts are accessing the master station over the serial links then the setting should be 'Separate'.

Once the settings are correct, press 'MENU' to install the settings and return to the previous page.

9.3 Loop Data

In section 7.4 the various pieces of information relating to the loop wiring and the cable parameters were measured and recorded. When it comes to setting the master station Loop Data the Loop Speed has to be compatible with that data (also the individual field units must be set to match the master station setting). The following table indicates the Loop Baud Rate that may be used for various values of cable resistance and capacitance.

Setup	
Loop Speed	110, 300, 600, 1200 or 2400 baud
Number of FCU's	In the range 1 to 240
Doubling	On or Off

□ Pakscan Cable Capacitance

Baud Rate	R max (ohms)	C max for 240 FCU system (μF) ^①	C max for 60 FCU system (μF) ^①	C max for 20 FCU system (μF) ^①
110	500	3.97	4.36	4.45
300	500	1.57	1.98	2.05
600	500	1.02	1.41	1.49
1200	500	0.07	0.47	0.55
2400	500	N/A	0.17	0.25

① Each field unit has a capacitance of 2.2nF
The C max figure given is the maximum value for the cable capacitance without the field units connected.

Note: Never attempt to run the system with cable resistance and capacitance values above those specified for the chosen baud rate as communication may not be possible.

To set the loop parameters, start from the Top Setup Menu (as shown in section 8.8.1). If the Ports have just been set then this is the screen displayed.

Press '3' to select Loop Options. The screen revealed is as shown in section 8.8.4.

Press '2' to step around the available baud rates, when the correct one is revealed leave it there.

Press '3' to set the number of the highest address for the connected field units on the loop. Enter the number of the highest address with the keypad numbers and press 'Load' to confirm the setting. The Master Station will then only poll around field units up to and including this address number. Note that if the Master Station is a 60 channel unit it cannot have the highest address set above 60, likewise for a 120 or 180 channel master station.

Press '4' to toggle between Baud Rate Doubling 'On' or 'Off'. Most systems will probably want to be run with doubling on, as this improves the speed of communication on the loop by a factor of 2. However whilst commissioning the system it may be better to start with this option set to 'Off'. It can always be change to 'On' once the loop is successfully operating. Take care when upgrading from an older Pakscan II system as the baud rate doubling function will only operate successfully if all the field units are also upgraded to Pakscan IIE standards.

Once these three parameters are set they will only become active when this screen is left by pressing 'MENU'. This returns to the Top Setup screen shown in 8.8.1.

9.4 Tag Names

It is possible to insert a tag name for every field unit, and also for the master station itself. Tag numbers help maintenance in checking that they have the right MOV. Tag names can also be set using the MasterTools PC based utility connected to the serial port, or by the Pakscan Ethernet Web browser utility.

Option '5' on the screen shown in section 8.8.1 selects the Tag Name Setting screen (as shown in section 8.8.6).

By pressing buttons '1', '2', or '3' you can select which field to edit. To select a different field unit address, simply use the 'Up' or 'Down' arrow keys. Section 8.6.5 explains how to select the letters and characters for a tag name.

9.5 Date and Time

From the 'Top Setup Menu' as shown in section 8.8.1, select option '6' to enter the 'Date and Time Setup'.

The screen revealed is as shown in section 8.8.7. Pressing buttons '1' or '2' allows the date and time settings to be modified. In most cases the clock will have been set to U.K. or U.S. time prior to shipment. If daylight saving time changes are in use in your territory then the clock will need altering when this local time change occurs. The clock is used for time stamping messages from the Pakscan Ethernet alarm e-mail system.

9.6 ESD Configuration

From the 'Top Setup Menu' as shown section 8.8.1, select option '7' to enter the 'ESD Options Setup'.

The screen revealed will be as shown in section 8.8.8. It is possible to enable or disable the ESD action from the 3 possible sources on the system. The default is to disable ESD on all inputs.

Pressing '1', '2', or '3' will toggle the mode for the labelled input between enabled and disabled. This function allows the keypad ESD input to be inhibited, in which case the prompt is removed from the master station commands screen. Similarly the remote terminal input or serial control inputs may be inhibited.

Note: It is always recommended that the external link on terminals 10 and 11 is made even if the ESD input is not in use so as to ensure that the inadvertent changing of these settings does not produce an unwanted ESD action.

9.7 Security Access Level

System access security is provided using two parameters, a PIN and the Access level. In general no setup data or commands to the actuators can be issued from the keypad unless the required PIN has been set. If access has been gained using the PIN, then the future requirement for a PIN can be removed, or the level of access required for issuing commands and altering the setup altered.

At any time the PIN may be entered. Pressing the * key reveals the PIN entry screen. Successful entry is acknowledged whilst an unsuccessful entry prompts for a retry. PIN's may be any number in the range 1000 to 9999. The default PIN on shipment is set to 1000.

From the 'Top Setup Menu' as shown section 8.8.1, select option '8' to enter the 'Security Setup'. The screen revealed will be as shown in section 8.8.9. It is possible to enable or disable the requirement for a PIN or change the Access level from this screen as well as define a new PIN.

The PIN may be placed in or out of use by option 1. A new PIN may be specified using option 2 and the access level altered using option 3. If the PIN is out of use then the access level is automatically at level 1 - no restrictions on what may be done via the keypad.

Set the required PIN by pressing '2' and entering the required number. It must be 4 digits in the range 1000 to 9999. Once it is entered make sure that the access level is set correctly.

9.8 Final Checks

Once all the parameters are set, revisit each screen for setting the Ports, Loop, Tags, Time ESD and Access settings to make sure they have loaded correctly, and that there are no mistakes.

As a final operation, note all the settings on a record sheet such as that shown in Section 15.

(This page is intentionally blank)

10 SETTING A HOT STANDBY PAIR PARAMETERS

If the system is a Hot Standby pair then the rack will contain two identical master station PS100 modules, two Power Supplies, PS210, and a Switch module, PS300. In addition it may contain one or more Ethernet bridges and two PS410 RS232/RS485 converters.

The two master stations must be set to have identical parameters for controlling the loop, and will usually have identical settings for the communication ports. If a common RS485 highway is used to communicate with a host then often both the master stations have the same Modbus address. The information in section 0 above can be used to set up both stations.

Check that the S/W Type is the same on both units of the pair. The software version is reported on the top diagnostic screen as shown in section 8.7.1.

10.1 Copy Data A to B

The master station is able to copy data from one side to the other as described in section 8.8.3. Copying only occurs from the Main unit of the pair. If the Modbus address is to be different on the two master stations (because of the way the host is to be configured) set these according to the host system requirements, but be careful regarding the “copy to standby settings” in section 8.8.3. The default condition is to copy tags, address and all parameter data between the two stations.

10.2 Changes to Terminal Connections

Whenever there is a PS300 Switch module in the rack, and a Hot Standby pair of master stations, there are connections that must not be made, and some additional connections to make to the rear of the master station rack.

All the connections are made to one set of terminals only. These are the terminals associated with master station 'M/S A' - the left hand master station of the pair, viewed from the front of the rack.

- The loop connections are made to the 'M/S A' side terminals only.
- The ESD input connection is made to the 'M/S A' side terminals only.
- DO NOT fit links between Terminal 22 to 23 of either master station.
- DO NOT fit links between Terminal 24 to 25 of either master station.

10.2.1 Main/Standby Connections

It is possible to define whether the left hand (A) or right hand (B) master station will be the unit that becomes the Main unit and assumes control when both sides are powered on simultaneously. If the link indicated below is not fitted the unit that powers on first will assume Main status.

- On the 'M/S A' terminals only:
 - Link terminal 18 to 19 to select 'M/S B' as the 'Main' unit.
 - Or Link terminal 20 to 21 to select 'M/S A' as the 'Main' unit.

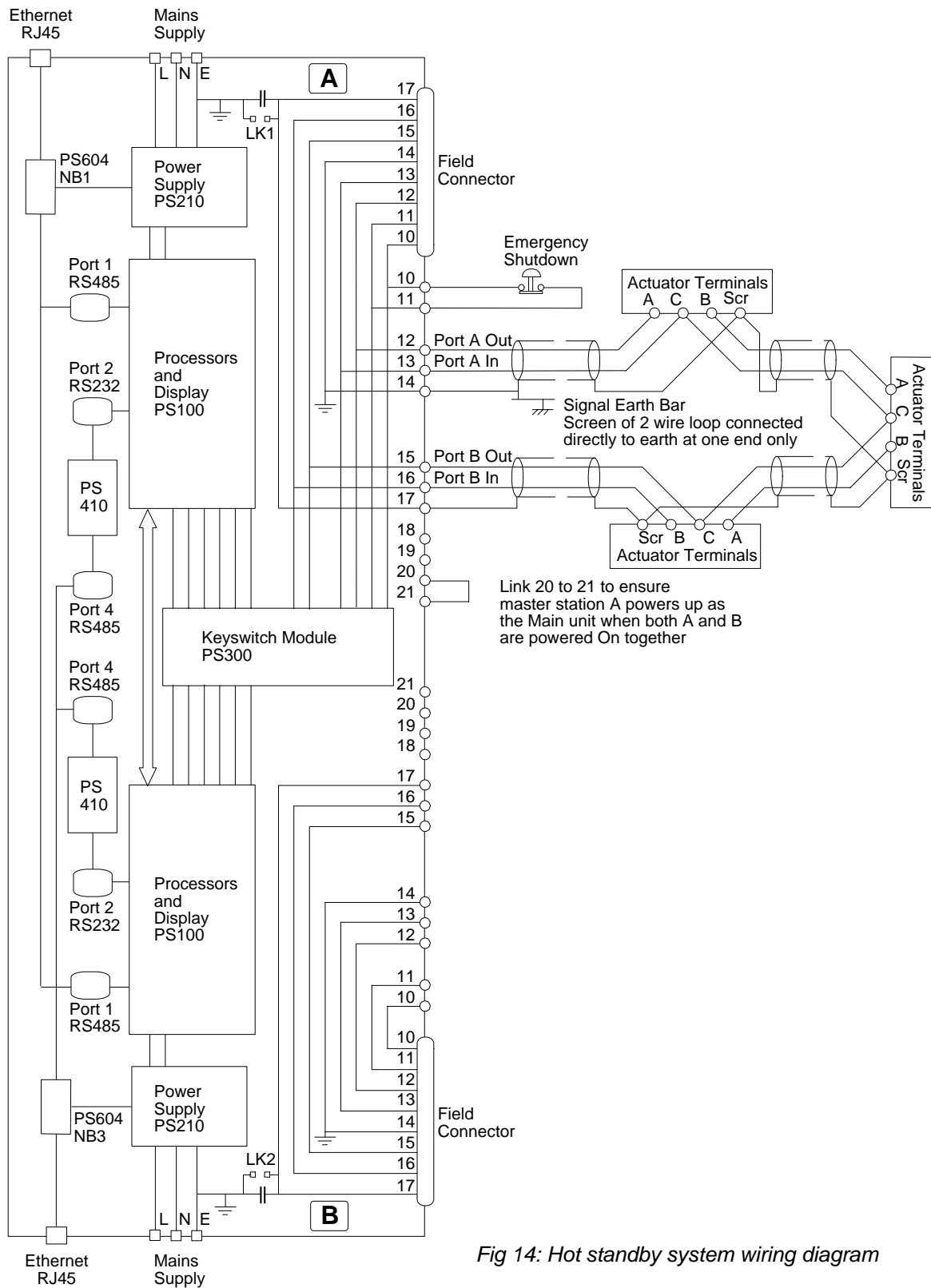

Fig 14: Hot standby system wiring diagram

10.3 Hot Standby Parameter Setting and Options

When setting the communication port options, as described in 9.2 above, there is an additional option on the screen shown in section 8.8.2. With a master station module, in a hot standby pair, it is possible to set it up to be Active or Passive when in standby mode by pressing button '5'.

The main unit of the pair will always respond to messages it receives on the port. This setting allows the action of both units when in standby mode to be set. If the setting is made 'Standby Passive', the unit will not respond to most of the messages it receives when it is in standby mode. The exception to this rule is a message to 'Change Master', this will be accepted by a unit in standby mode even if the port setting is 'Standby Passive'. (Allowing this one command to be accepted allows a host system using a direct comms link to the standby unit to make that unit adopt main mode if the link to the main unit fails.)

If the port is set to 'Standby Active' it will always respond to all messages when it is in standby mode. Both units in the rack must be set to the same value for this parameter – they must never be different. In most serial comms systems using multi-drop RS485, and in those systems fitted with Ethernet bridges, the setting will most commonly be 'Standby Passive'.

Note: When one common RS485 link is used connecting the RS485 port on station A to the RS485 port on station B station, the comms ports must be set to 'Standby Passive'.

However if two independent communication links to the host are used then both stations should be set to 'Active'. This will ensure that both respond to messages to or from the Host computer. Note that whatever the setting only the master station that is actually in control of the 2-wire loop will issue commands to the loop. So with a system using two communication links it is the responsibility of the Host computer to direct instructions to move valves to the correct master station of the pair.

- RS485 on A side connected to RS485 on B side, set A and B to Standby Passive
- RS485 on A side independent of RS485 on B side, set A and B to Standby Active
- Ethernet bridge connecting to both the A side and B side, set A and B to Standby Passive

During normal operation it is also possible to change which of the two sides is in control of the loop. In the Master Station Commands menu, (refer to section 8.5), button '3' allows the master to be changed. Note that this is only operative on the current 'master' unit of a pair. It can relinquish control and become the standby unit, making the other master station the 'main'. When commissioning the system this feature should be checked. The standby LED is lit on the station that is in 'standby' mode.

10.4 The PS300 Keyswitch

The PS300 keyswitch is located in the centre of the rack, between the two master stations. This unit is used to force one or the other station to be connected to the loop, allowing the other, disconnected one, to be safely removed without interrupting the loop.

The Key is removable in the lower Auto position only. When that position is selected both stations are operating in Hot Standby mode. If a unit fails, then the keyswitch should be moved to select 'A' if 'B' is to be removed, or moved to 'B' if 'A' is to be removed. The key should not be returned to the 'Auto' position whilst a master station is removed from the rack.

The key rotates through 4 positions and is only removable in the Auto position.

- Select Auto for normal operation
- Select position B before removing master station A
- Select position A before removing master station B

There are no electronic components on the PS300 module and its function is solely to allow a unit to be removed for repair.

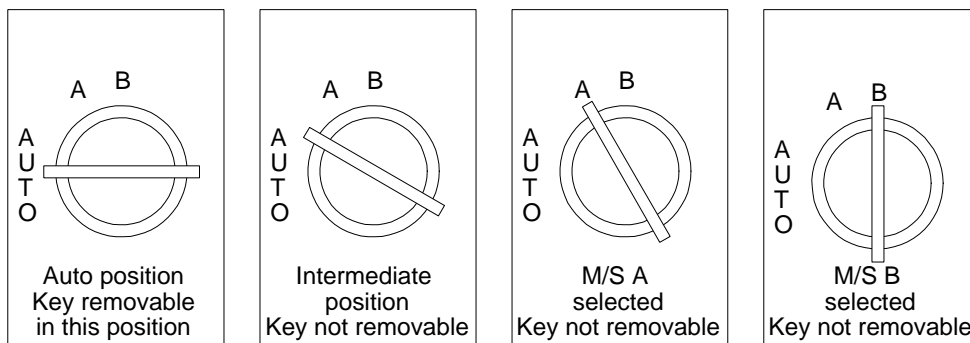

Fig 15: PS300 Keyswitch positions

After a master station is replaced return the key to the normal position. It may be necessary to reset the loop in order to completely restore correct operation.

11 INCLUDING A PS410 CONVERTER

Within the master station rack there are two pre-allocated positions for PS410 RS232/RS485 converter modules. These are fitted when there is a need for two RS485 or two RS232 highways to the master station. Occasionally they may also be fitted to accommodate the requirements for dual Ethernet communications.

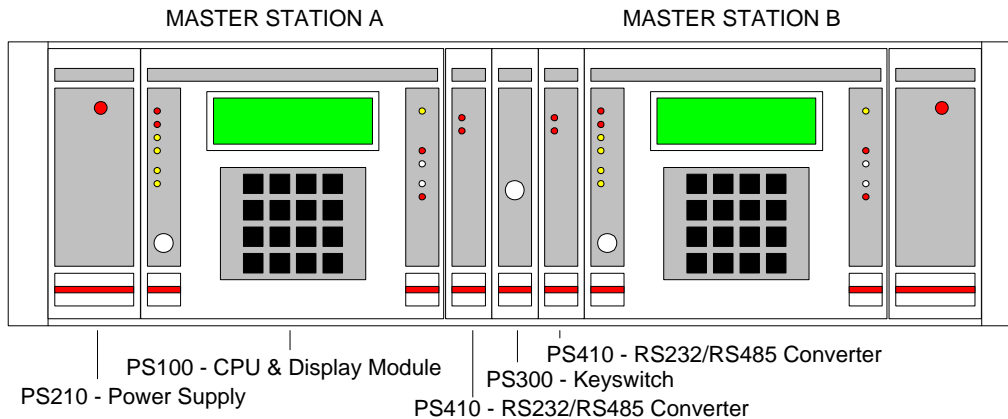

Fig 16: Master station front showing PS410 and PS300

The PS410 provides an RS232 to RS485 conversion that allows each of the master stations to be set up with either 2 RS485 serial ports or 2 RS232 serial ports. On the RS485 side the converter supports both 2-wire and 4-wire communications and is true RS485. There is a similar stand-alone version, the PS412, which can be used in conjunction with the Pakscan equipment. There are activity LED's on the front panel showing transmit and receive data. The unit is designed to operate without the need for an enable signal from the host computer, relying instead on line activity to enable the RS485 transmitter.

The two options require different installation of the card.

- When there is a need for two RS232 ports an external link must be fitted from Port 1 to Port 4 and the internal jumpers fitted to 'convert Port 1 to RS232'.
- When there is a requirement for two RS485 ports there is no link needed and the jumpers must be set to 'convert Port 2 to RS485'.

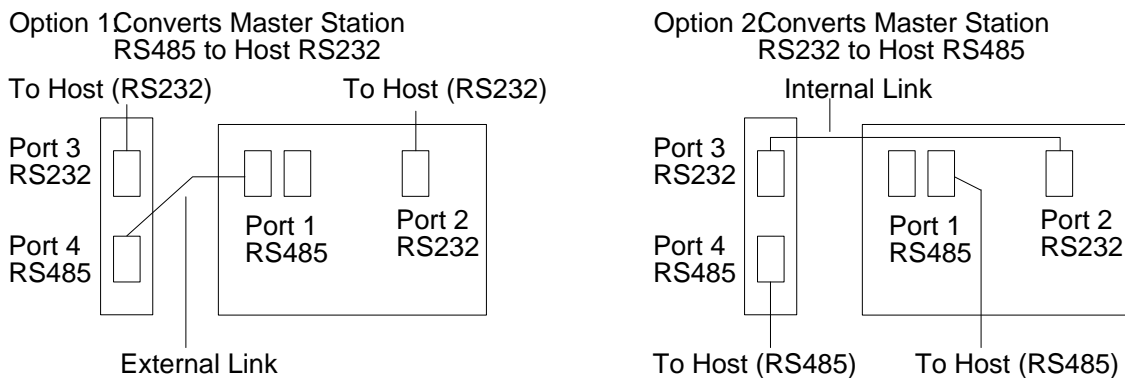

Fig 17: PS410 Converter connection options

11.1 Jumper functions

Internally the PS410 has several jumpers used to configure the card to match the performance required. Once the function has been set the next most important setting is the use of bias and termination resistors on the RS485 highway. In general termination and biasing should only be fitted once to any RS485 highway and it should be at the host connection end.

Jumper	Position	Function when fitted
J1	1-2) Convert master station port 1 to RS232
	4-6)
	7-8)
	2-3) Convert master station port 2 to RS485
	5-6)
	8-9)
J2	1-5	Select baud rate 19200) Fit one only
	2-6	Select baud rate 9600)
	3-7	Select baud rate 4800)
	4-8	Select baud rate 2400)
J3	1-2	RS485 data line bias resistor
	3-4	RS485 data line bias resistor
J4	1-2	RS485 data line termination resistor
J5	1-2	RS485 control line bias resistor
	3-4	RS485 control line bias resistor
J6	1-2	RS485 control line termination resistor
J7	1-2) 2-wire RS485 communications
	7-8)
	or	or
	3-4) 4-wire RS485 communications
	5-6)

11.1.1 PS410 port 2 to RS485 setup

To use the PS410 to convert the master station RS232 port (port 2) to a second RS485 port.

- Set J1 to positions 2-3, 5-6 and 8-9 (marked 'PORT 2 TO RS485' on the PCB)
- Set J2 according to the baud rate to be used
- See Section 11.1.4 for details of setting J3, J4, J5 and J6
- RS485 communications will use the 'Port 4' connector on the back of the rack. Note that the Port 2 connector can no longer be used.
- Set J7 for either 2-wire or 4-wire RS485 communications.

This second RS485 port is isolated and has the same I/O connections as the master station port 1.

11.1.2 PS410 port 1 to RS232 setup

To use the converter to convert the master station RS485 port (Port 1) to a second RS232 port.

- Set J1 to positions 1-2, 4-5 and 7-8 (marked 'PORT 1 TO RS232' on the PCB)
- Set J2 according to the baud rate being used
- Set J7 to positions 1-2 and 7-8 (2-wire mode)
- Set jumpers J3, J4, J5 and J6 according to Section 11.1.4
- Connect Port 1 and Port 4 together at the back of the rack with a length of cable terminated in 9-way D-type connectors. Ribbon cable is suitable.
- RS232 communications will use the 'Port 3' connector on the back of the rack.

This second RS232 port is isolated, and has the same I/O connections as the master station port 2, except that the 'CTS' signal is not supported.

11.1.3 LED functions

The top LED comes on when data is being transmitted on the RS485 side. The bottom LED comes on when data is being received on the RS485 side.

11.1.4 RS485 line conditioning

Proper conditioning of a multi-drop RS485 serial link is essential if it is to work properly. It should ideally be terminated with about 120 ohms at each end, but NOT at each node, and at one point only on the link there MUST be 'pull-apart' resistors to bias the line to the idle state when nobody is driving it. Provision for both data line termination, J4, and 470 ohm pull-apart resistors, J3, is made on the Converter. Whether or not the jumpers should be fitted depends on the design of the whole system. Jumpers J5 and J6 carry out similar functions for the RS485 control line.

In practice, some experimentation may be necessary to find the correct setting of these jumpers in each application. At the baud rates that the master station uses, line termination (J4 and J6) often does not have much effect, but the 'pull-apart' resistors (J3) are critical to successful communications. Without the 'pull-apart' function, communications may be subject to many errors or may fail completely.

If 4-wire mode is selected, J3 and J4 operate on the Transmit lines, and J5 and J6 operate on the Receive lines.

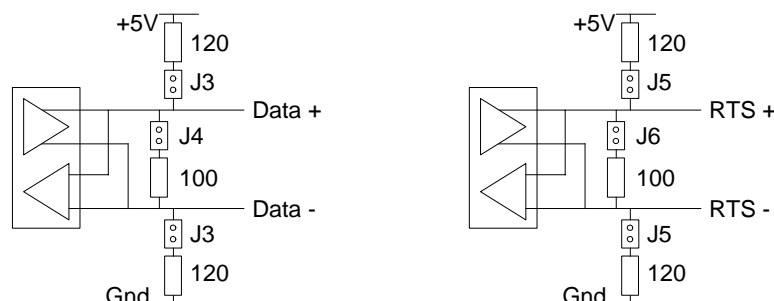

Fig 18: PS410 Converter bias and termination resistors

11.1.5 2-Wire and 4-wire RS485 communications

A 2-wire RS485 communications link consists of at least the following signals:

- Data +
- Data –
- Signal ground

'Data' and 'Data*' are a balanced, bi-directional pair of signals which carry both transmitted and received data. Note that the nomenclature used for the pair varies, '+' and '-' or 'A' and 'B' are sometimes used. The PS410 also supports a control line, RTS.

A 4-wire RS485 communications link consists of:

- Tx +
- Tx –
- Rx +
- Rx –
- Signal ground

Transmitted and received data have their own pairs of wires. The Pakscan IIE master station Port 1 supports 2-wire RS485 communications only.

12 SETTING UP AND USING THE PS600 ETHERNET MODULE

The Pakscan IIE master station may include PS601/2/3/4 Ethernet modules to allow direct Ethernet connection to the control system. These modules connect to either one or both stations when a hot standby system is being used. They are located in the rear of the rack, behind the cards and in front of the connection plane. Power for the module is drawn from the PS210 power supply in the master station rack.

The connection to the Ethernet LAN uses RJ45 connectors industry standard Modbus TCP protocol and the data base format presented to the LAN is identical to that used for Modbus RTU communication. If the master station is selected for Generic protocol then the Ethernet bridge also makes available web server and a number of system diagnostic and control screens. These screens are not available when Yokogawa or any other protocol is selected. In order to view these screens it is necessary to connect a suitable PC with a web browser such as Microsoft Internet Explorer.

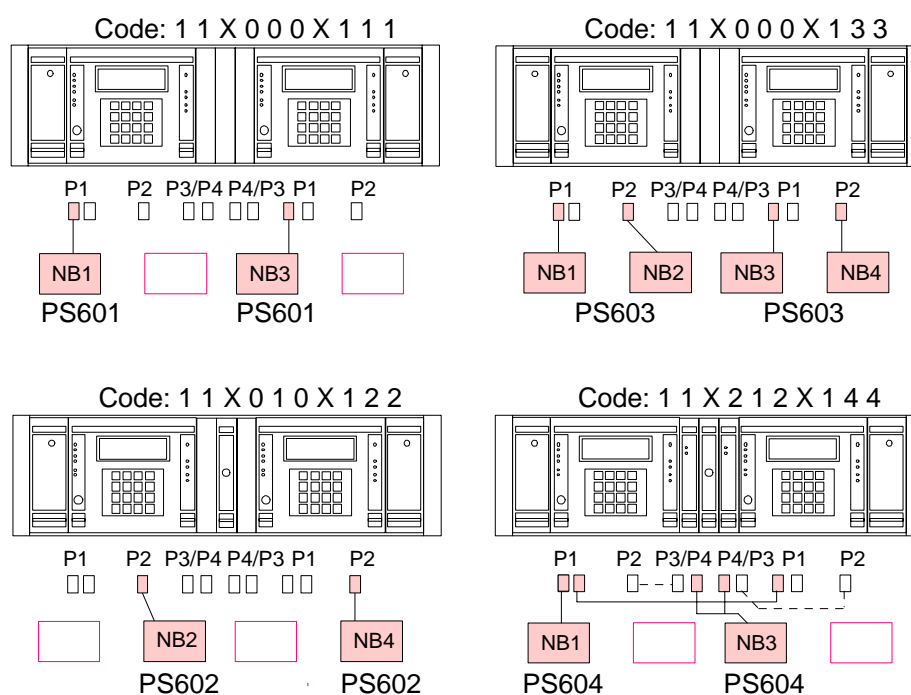

Fig 19: PS600 Ethernet bridge options

The Modbus TCP port support 10/100 Mbps Ethernet and up to 10 simultaneous users. It requires configuration for address and user permissions during the system commissioning.

- PS601 connects to the RS485 port of the master station PS100 module (port 1)
- PS602 connects to the RS232 port of the master station PS100 module (port 2)
- PS603 is two modules, each connected to a port of the PS100 module (port 1 and 2)
- PS604 is for hot standby systems and connects to port 1 and 4 on both master stations

12.1 Internal Connections

The module is connected to the master station port 1, 2 or 4 using an RJ12 connector on the module and the 9 way D type on the rear of the rack. The cable used is specific to the type of connection, either RS232 or RS485. Power is connected to the terminals on the opposite side to the RJ12 serial connection. Note that the 9-way D type connector on the module must not be used.

RJ12 Pin	Function
1	RS485 Line A
2	RS485 Line B
3	Ground
4	Ground
5	RS232 transmit
6	RS232 receive

12.2 Connecting to the Ethernet Bridge

The Ethernet connection uses a standard RJ45 connector, an extension cable is inserted in this connector and the loose end (RJ45 socket) is available for external connection the master station assembly.

RJ45 Pin	Function
1	Tx +
2	Tx -
3	Rx +
4	Rx -

When connecting to a LAN the master station should be connected to a hub or switch using a standard category 5 Ethernet cable (UTP).

Note: If the master station is connected directly to the Ethernet port on a PC a cross over cable must be used.

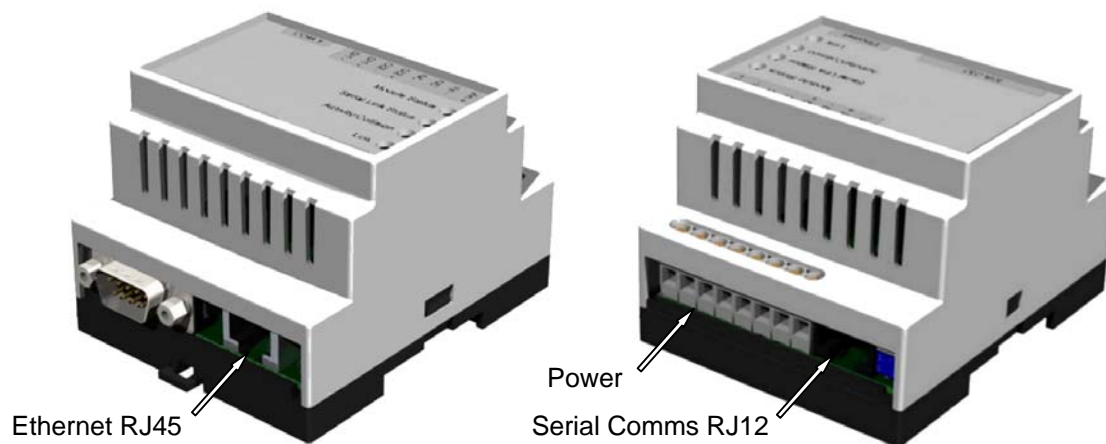

Fig 20: Ethernet bridge

Once connected to the PC, either via a LAN or directly, the Ethernet bridge may then be set up or the web pages accessed.

12.2.1 Local Ethernet Connection

- The Ethernet bridge default I/P address is: **10.200.1.1**.

For local Ethernet connection, consult your network administrator. The LAN administrator will control the rules and permissions used on your site. The connection of any device is generally only permitted if these rules are met.

12.2.2 Direct Ethernet Connection to a PC

An Ethernet cross over cable is required to directly connect the master station PS600 module to a PC Ethernet port without using a LAN. It is also required to set the PC's TCP/IP connection properties to a Static Address instead of allowing the PC to 'Obtain an IP Address Automatically'.

- Set PC connection properties to **Static IP Address**

12.2.2.1 Connection using Windows XP

To set up a PC using Windows XP carry out the following steps –

- Go to Start>Settings>Control Panel>Network Connections and right click on the Local Area Connection Icon.
- Select Properties
- Under the General Tab, double click on the "Internet Protocol [TCP/IP] Icon
- Under the General Tab, change the "Obtain an IP Address Automatically" to "Use the Following IP Address"
- Enter the following IP address: 10.200.1.2
- Enter the following Subnet Mask: 255.255.255.0
- Click OK

When completed, use a web browser pointed at address 10.200.1.1 to access the PS600 module. When the log on screen appears, use the following log in data to sign in -

- User Name = admin
- Password = admin

(Note that the user name and password entered is all in lower case.)

Configuration and settings can now be carried out. When completed, make sure you reset your TCP/IP connection properties to 'Obtain an IP Address Automatically' once more.

12.3 Ethernet Module Status Indicators

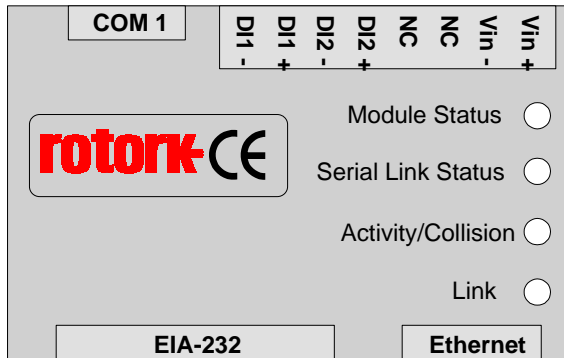

Fig 21: Top view of the Ethernet bridge module

The module includes four bi-colour LED's that are used to show the status and activity of the device. The function of these indicators is shown in the table and their status can be used to diagnose the activity of the module.

12.3.1 LED Functionality

Title	Colour	Function
Module Status	Off Green Orange	No Power Module is running in normal mode During boot up
Serial Status Link	Flashing Green Flashing Red Orange	Serial Packet Receive Serial Packet Transmit During boot up
Ethernet Activity/Collision	Flashing Green Flashing Red	Ethernet Packet Received Ethernet Collision Detected
Link	Off Green Orange	No Ethernet Link Detected Ethernet Network Detected, 10 Mbps Ethernet Network Detected, 100 Mbps

12.4 Setting Up the Module

Once the PC is connected to the master station either by a cross over cable or locally via the LAN it can be set up for the particular application for which it is intended. The following notes assume that Microsoft Internet Explorer is used as the web browser for the connection. Other browsers will produce similar results. The module cannot be set except over the Ethernet connection.

- Browse to the module using default IP address 10.200.1.1

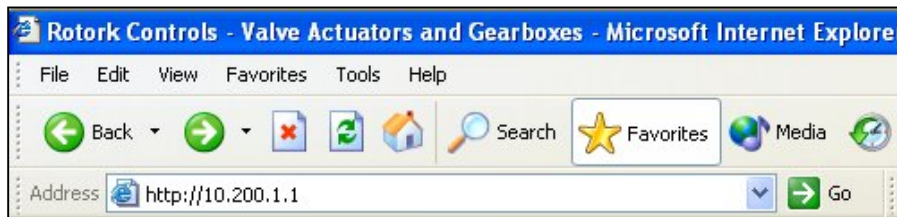

Fig 22: Browsing to the Ethernet bridge module with Internet Explorer

- The user log in screen will appear once the connection is made



Fig 23: Ethernet Log In screen

In order to set up the final IP address, the master station protocol to use between the Ethernet and the PS100 and so on it is necessary to log in at the highest level as an administrator.

The master station ships with the default settings indicated below for administrator access, these should be altered as soon as possible to ensure system security.

Default User Name = admin
 Default Password = admin

Once entered at administrator level all the settings can be altered and user accounts set up. The opening screen is displayed as shown below.

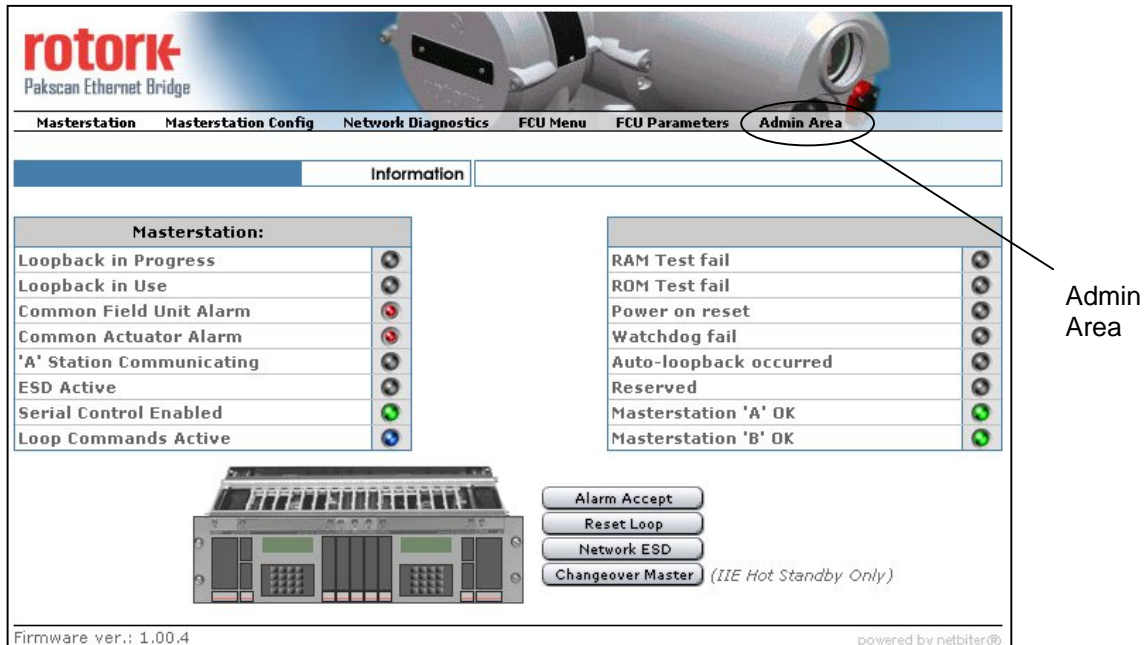

Fig 24: Web Server opening screen

12.4.1 Setting the Serial Connection Fields

Click on the **Admin Area** then select **Serial** from the menu that appears below Admin Area.

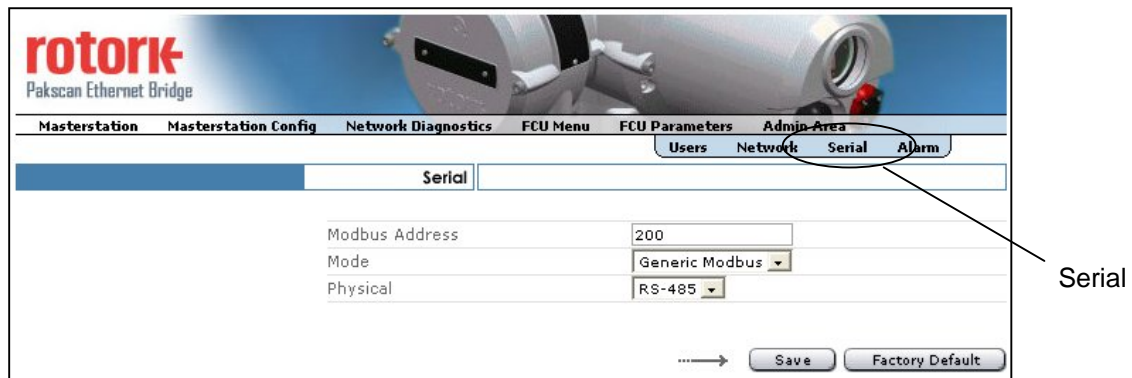

Fig 25: Serial Comms to PS100 setup screen

The serial communication screen allows the settings between the bridge and the PS100 module to be set.

- Modbus address: The address must match the Modbus address set for the master station under section 8.8.5. The default is address 200.
- Mode: The mode may be Generic Modbus or Yokogawa. For the web browser to operate and show master station and field unit data this must be set to Generic Modbus.

- If the host Modbus TCP connection requires Generic Modbus or Honeywell PLCG protocol, set the mode to Generic Modbus. Note that the analogue data format is the only difference between these two data bases.
- If the host Modbus TCP connection requires Yokogawa or Honeywell SI protocol, set the mode to Yokogawa. Note that the analogue data format is the only difference between these two data bases. Also note that the web browser will not be available with this setting as it does not populate with the correct data.

Physical:

The physical layer will have been set at the factory before shipment and must match the type of physical port to which the bridge is connected. This can be either RS232 or RS485 and different cables are used for the two choices although the RJ12 connector is always used.

12.4.2 Setting the User Fields for the Web Browser

When the web browser feature is being used it is possible to set up several users, each with their own password and email alarm notification who will have access to the system. If the email feature is not required then it need not be used. Existing password settings cannot be seen or recovered from the system. New users can only be added by an Administrator.

From the **Admin Area** then select **Users** to open the screen shown below. This is the default screen that opens when the Admin Area is selected and is only accessible if the Administrator password has been entered. All the users are listed and the access permission for each is shown. To modify a user, select them and an Edit screen similar the Add screen allows alterations or deletion of user data.

Select Add and the user profile editing screen appears that allows a new user to be set up on the system.

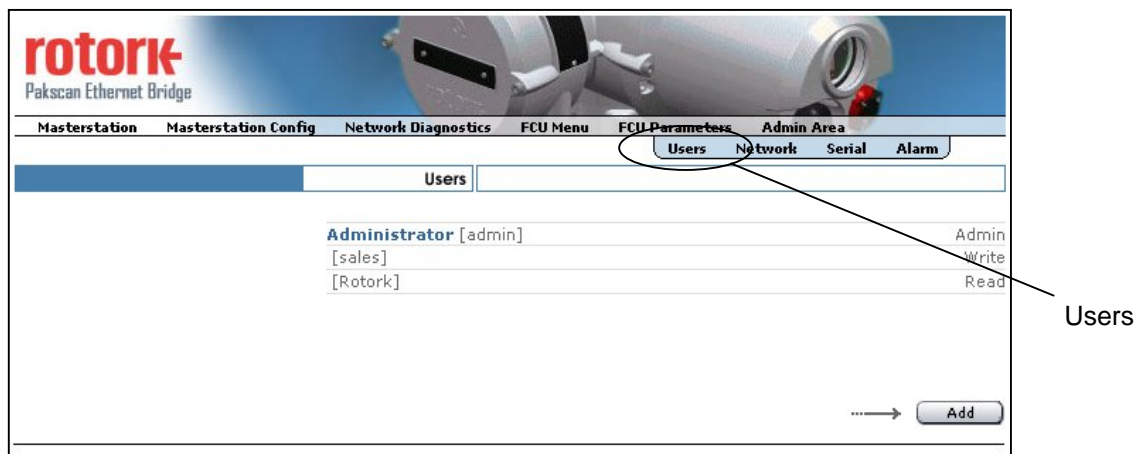

Fig 26: Users screen

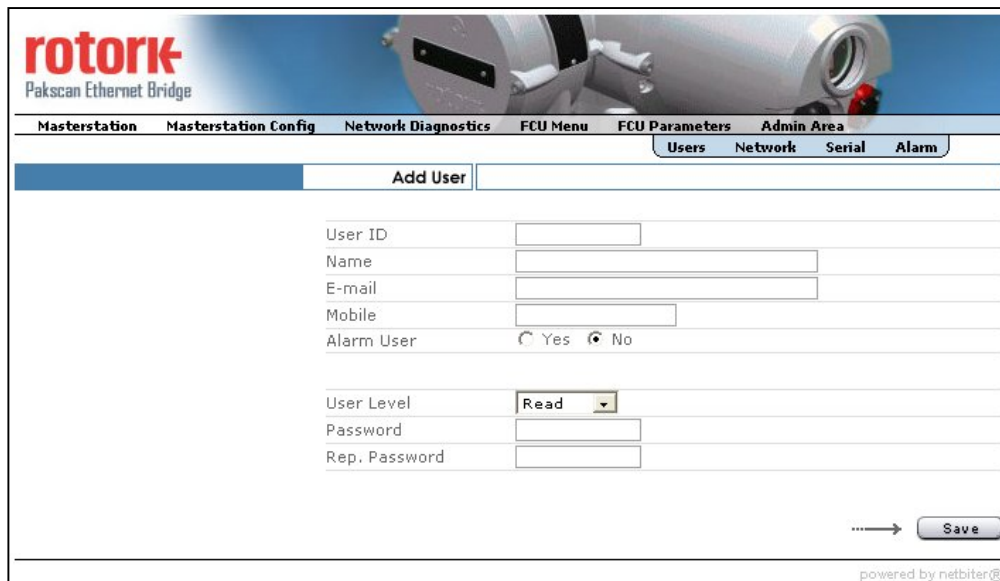

Fig 27: Users profile setup screen

The user profile fields are entered as appropriate. Only administrators have access to these fields.

Field	Function	Example
User ID	Name of the user as entered in the initial connection security screen	Engineer1
Name	The name used to identify the user	John Smith
E-mail	The address to send e-mail messages to for this user. Leave blank if e-mail messaging is not required	John.smith@anymail.com
Mobile	Not implemented on Ethernet – leave blank	
Alarm User	Yes – E-mail alarm messages will be sent to the address entered No – E-mail messages are inhibited	Yes
User Level	Read – allows viewing of data only Write – allows settings to be altered and valves to be moved Admin – allows full administration and access to all functions	Write
Password	The password used by this user on initial log in. Passwords are case sensitive and they are not revealed on this or any other screen	rabbit
Repeat password	Repeat the password for confirmation	rabbit

When the fields have been completed, click on 'Save' to retain the data and user profile.

12.4.3 Setting the Alarm Messaging Information

Emails may be used to report critical alarms. The email messages sent to the specified recipients are the same for all recipients. The decision about who gets the message is made in the user profile. This screen allows the information to be sent in email form to be selected.

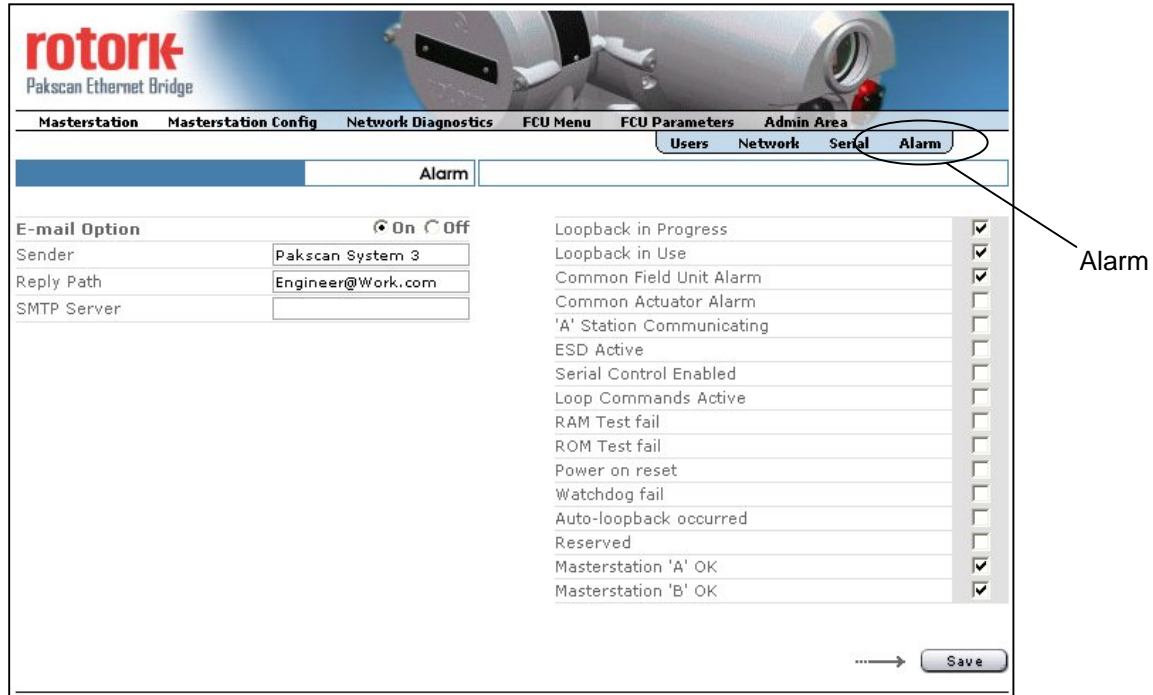

Fig 28: Alarm reporting setup screen

The left side of the screen sets up email facilities and right side is used to select the alarms.

Field	Function
E-mail Option	On – E-mails will be sent to the addresses specified in the user profiles. Off – No e-mails will be sent
Sender	A name used to identify this Pakscan system (messages will be titled by this name to indicate which system it is).
Reply Path	The address to send e-mail reply messages to for this system. Typically this might be a manager. Engineers responding to an alarm can send a message indicating it has been attended to.
SMTP Server	The LAN system administrator will supply the name of the e-mail server to be used by devices on the network.

A tick in the box on the right hand side indicates that a message will be sent if the selected event occurs. If the status of the alarm goes to a '1' the message is created. If messages cannot be sent they will be queued until a connection is available. All messages are date and time stamped using the master station clock as the reference.

12.4.4 Setting the Local Area Network Connection Parameters

The settings for the Ethernet connection are made from the Network screen.

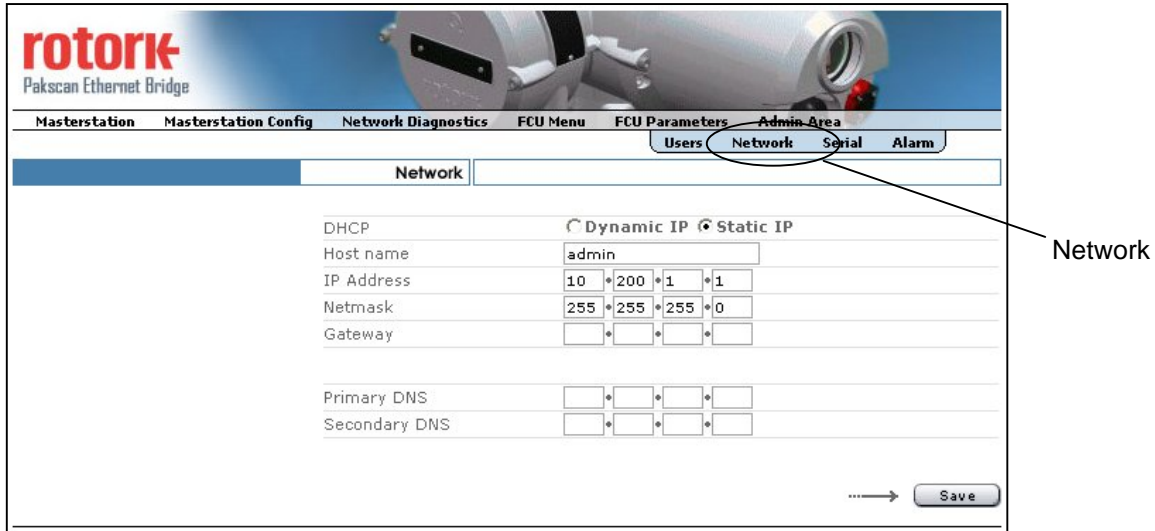

Fig 29: Network parameter setup screen

The LAN system administrator will normally provide the IP address and other settings. The settings will depend on how the network has been set up. It is usual to have a Static IP address for this type of equipment.

Make a note of the values once all the parameters have been set.

12.5 Using the Ethernet Connection

Once the module and LAN connections have been configured the Ethernet connection allows access to the Web Server pages inside the system. These pages are used to show information about the master station and allow some settings to be remotely altered. They also show the status of all the connected actuators and the parameters set inside the field units, and they even permit the valves to be moved provided the user has sufficient access rights.

Note: Up to 10 concurrent users are supported at any one time

12.5.1 Master Station Overview

The overview screen is the first screen displayed after a successful log in. The display will show either a Pakscan IIE or Pakscan IIS master station depending on the type of station accessed.

All users will have access to view the status, but only specified users can issue commands. When a command is selected such as Alarm Accept or Reset Loop a pop-up confirmation box appears and acceptance is required before the action takes place.

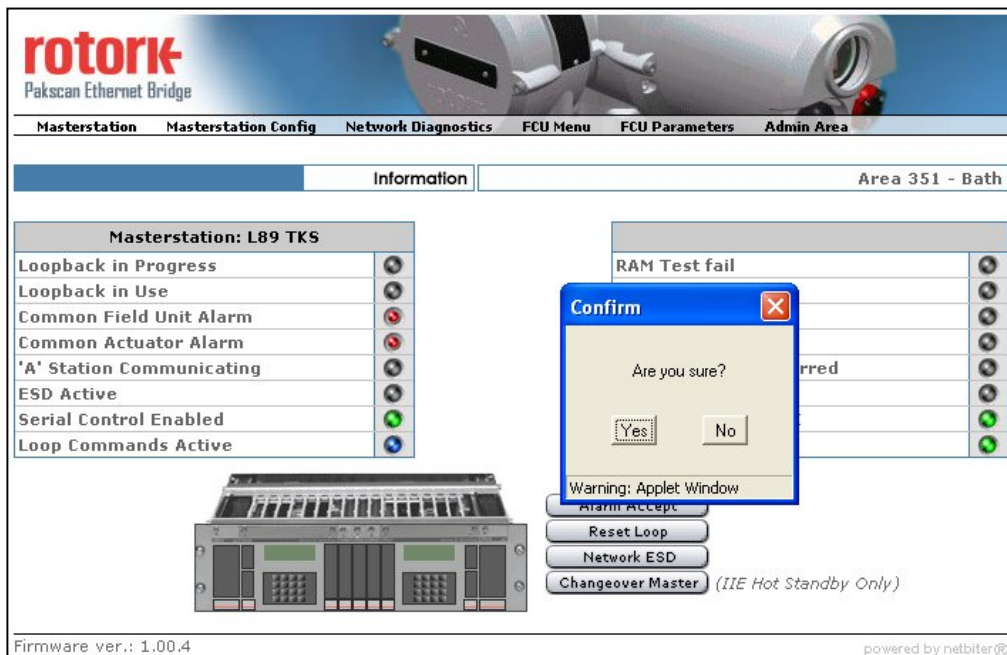

Fig 30: Master Station status screen and Pop-up confirmation box

The menu bar across the top of the screen is used to navigate to the other displays from this screen although the Admin Area is only available for users with administration rights.

12.5.2 Master Station Configuration

The master station settings can be viewed from this screen. Users with Administrator access are permitted to alter the settings, but great care must be taken when doing so as the results can lead to loss of control or communication with the system. The parameters that can be altered are described in detail in section 8.8 of this manual.

Changes are sent to the master station by clicking on the 'send' button for the section that has new values to be used. The print button allows a permanent record of the settings to be made.

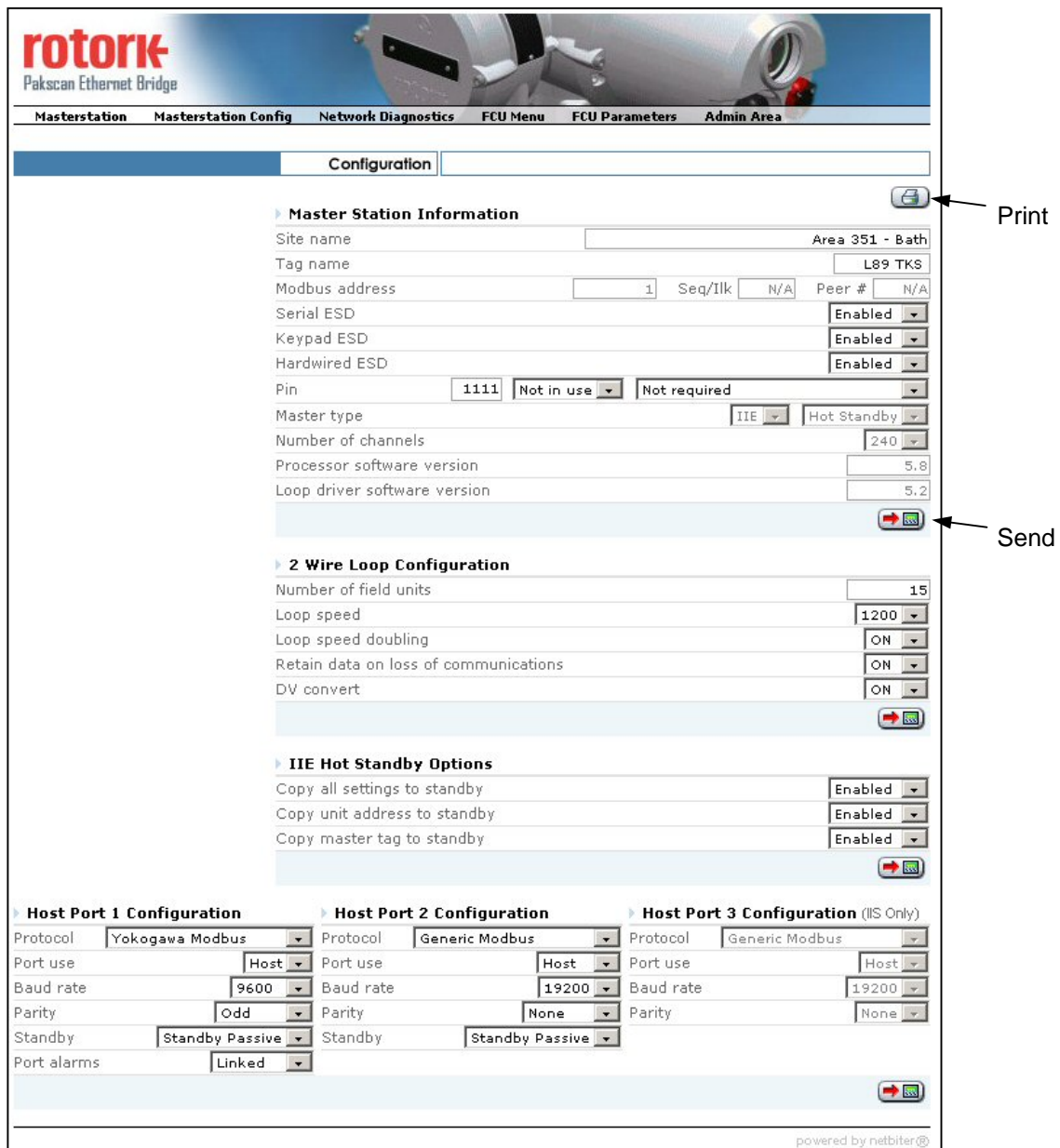

Fig 31: Master Station configuration screen

Some of the fields are fixed and cannot be altered from this screen as they are used to report basic settings of the system.

Note: Do not alter the Host Port Configuration for the serial port connected to the Pakscan Ethernet module. If this is changed communication between the PS600 and PS100 will be disrupted. The correct parameters must be re-entered from the local keypad on the front of the master station and their values will depend on the master station assembly and which port is connected to the Ethernet module.

The default port settings are -

Protocol: Generic Modbus
Port Use: Host
Baud Rate: 19200
Parity: None
Standby: Standby Passive (Applicable to Hot Standby master station)
Port Alarms: Separate

12.5.3 Network Diagnostics

The Network Diagnostics function shows the performance and configuration of the Pakscan loop. Much of the data shown is also available from the screen of the master station itself as described in section 8.7.4.

rotork
Pakscan Ethernet Bridge

Masterstation Masterstation Config **Network Diagnostics** FCU Menu FCU Parameters Admin Area

Network Diagnostics

Status Information		Fault Information	
No of devices on loop	15	Last loop reset initiated by	Loop configure command received
No of FCU's found on system	15	Loop fault type	No faults
Loop Status	Loopbacks off	No of FCU's on A side	15
Loop Baud Rate	1200	No of FCU's on B side	0
Loop config status	Wait for loopbacks 2		

Get loop map Reset Loop

Position	Address	Fails	Type	Tag
1	15	0	Integral	F56-001C
2	4	0	GPFCU - GP	F58-126
3	5	0	GPFCU - GP	F58-122
4	6	0	GPFCU - GP	F58-127
5	7	0	GPFCU - GP	F58-121
6	8	0	GPFCU - GP	F56-002A
7	14	0	GPFCU - GP	F56-001B
8	10	0	GPFCU - GP	F56-002C
9	11	0	IQ/IQT	F56-002D
10	13	1	Integral	F56-001A
11	12	0	IQ/IQT	F56-002E
12	1	0	Integral	F58-130
13	2	0	Integral	F58-129
14	3	1	IQ/IQT	F56-118
15	9	0	Integral	F56-002B

Fig 32: Network Diagnostics screen

The screen automatically builds a list showing all the field units in the order in which they are wired on the Pakscan loop. For this loop to be complete the actuators must all be powered up. The list includes details on the device type, the tag entered and the number of times the field unit has failed to respond. The 'fails count' can be used to indicate the current condition of each field unit. The counter increments for each message not acknowledged correctly even if communication is subsequently established within the 3 retry limit.

In addition the status of the field cable is shown and the location of any fault that is present, together with the nature of the fault. Any device in loopback is indicated in the table by shading the cells.

The loop can be reset and the map refreshed by using the two buttons provided.

12.5.4 FCU Menu

The FCU menu screen shows a list of all the field units on the system together with their tag name and actuator type. The list is in address order and includes any devices that are currently missing from the loop either because they are powered off or they have not yet been connected, but are within the span of the highest address to scan up to.

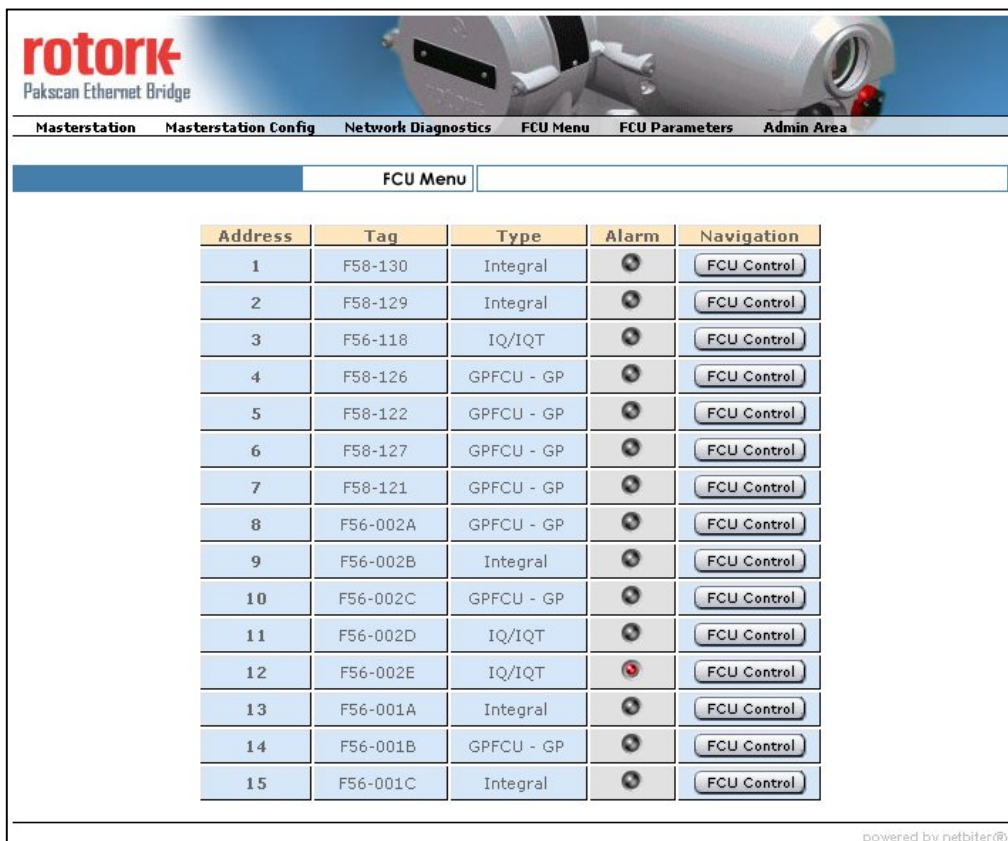

Fig 33: FCU Menu screen

- ❑ If there is an alarm present for the field unit then the alarm indicator will flash.
- ❑ Clicking on the FCU Control button reveals the control screen for the field Unit

12.5.4.1 Field Unit Status and Control

The FCU Control button brings up an additional screen that shows the current status of the actuator at that address.

Identification	
Tag Name	F56-118
Address	3
Type	IQ/IQT
Current Status	
Auxillary input #1	Inactive
Auxillary input #2	Inactive
Auxillary input #3	Inactive
Auxillary input #4	Inactive
Valve Position	Stopped mid-travel
Actuator	Stationary
Running Direction	-
Loopback	Off
Battery Status	OK
Alarm	No Alarm
Actuator Position	
62%	
Instantaneous Torque	
0%	

FCU Control

62

Slider

powered by netbiter®

Fig 34: FCU Status and Control screen

The basic status of the actuator is shown on the left and the picture on the right shows the type of actuator.

- The valve may be opened or closed, or set to an intermediate position using the buttons or slider control.
- The alarms present, and in the case of IQ actuators the torque profile, can be seen by clicking the appropriate button.

12.5.4.2 Field Unit Alarms screen

The alarm panel appears when the 'Show Alarms' button is clicked.

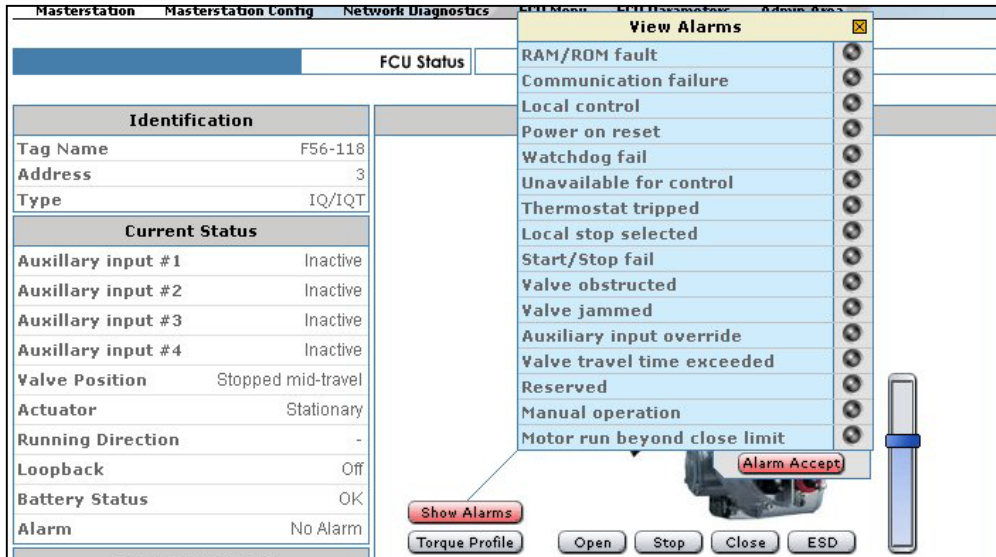

Fig 35: FCU Alarm screen

Any alarm that is present will be shown by a red symbol and alarms can be accepted from this screen. Alarms are latched until they are accepted, and once accepted the indication will return to normal if the alarm condition no longer exists. Clicking the Alarm Accept button will also accept alarms on the other field unit pages.

12.5.4.3 IQ and IQT Actuator Torque screen

The torque panel appears (for IQ actuators only) when the 'Torque Profile' button is clicked.

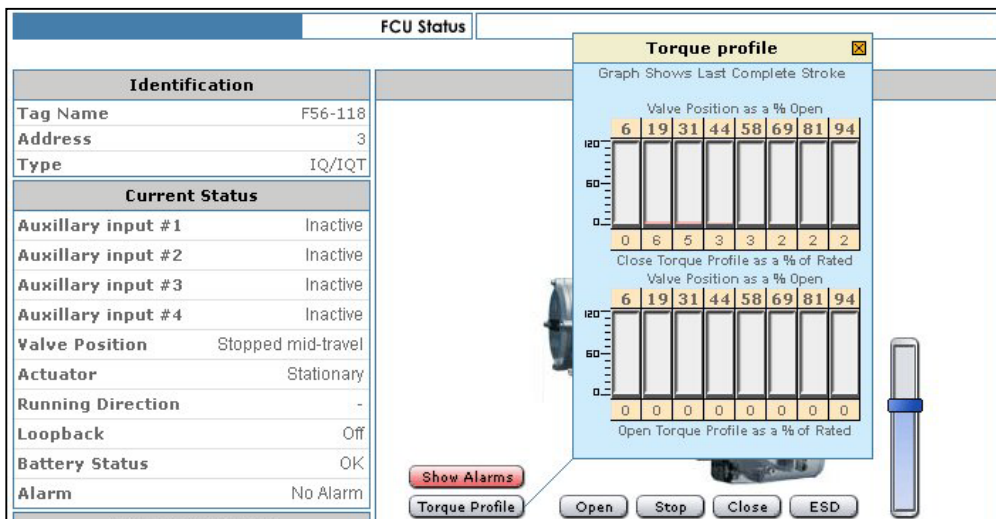

Fig 36: IQ/IQT Torque screen

The torque profile is shown in bar format for the last open to close and close to open valve movements.

Note: Historical Torque transmission must be enabled in the IQ field unit for this feature to become active. To make the FCU report the historical torque data the Torque Filter Factor must be set to 0. (0 makes the master station collect the raw data). See parameter settings in section 12.5.5.

12.5.5 FCU Parameters

Selecting FCU Parameters opens a screen warning that collecting the parameters from the FCU can take few minutes as all the parameters must be collected from the field units. The actual time taken will depend on the number of FCU and the loop speed, but in general it takes approximately 4 times longer than a loop reset.

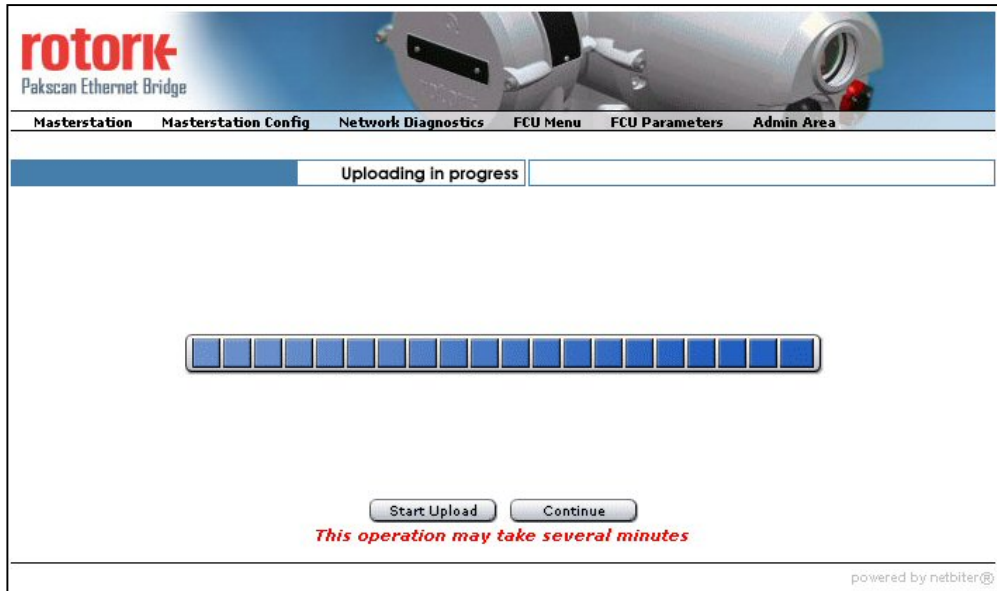

Fig 37: Parameter Upload screen

To commence the upload, click on 'Start Upload' and the progress bar will gradually fill as the parameters are collected.

Once the upload is complete the bar indicator will be completely full (similar to that shown above). Click on 'Continue' to move to the next screen. This shows a list of all the field units, their tag names and a button to write new names. In addition there is an 'FCU Parameter' button for each FCU that causes the individual FCU parameter screen to appear.

Individual tag names can be entered from this screen and sent to the master station. Tags are retained in the master station, not the individual field devices. These tag names cannot be accessed by the host system over the communication link and are only accessible to the Pakscan tools and Ethernet bridge.



Fig 38: Tag List and Parameter access screen

The field units are listed in address order and clicking the FCU parameter button leads to the individual field unit parameter screen.

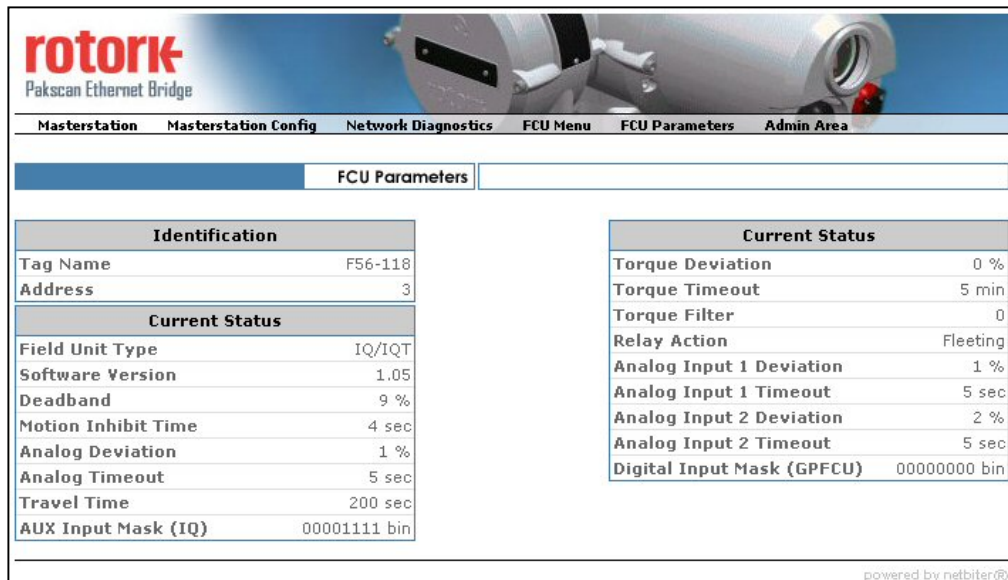

Fig 39: FCU Parameter screen

Every field unit has a number of configurable parameter settings that determine its operation in the network. If these are not correctly set then some features of the control system or the actuator may not

be available or function as expected. These screens allow the settings of all the field unit parameters to be examined including those relating to the operation on the network.

Note: Information about the field unit settings can be seen in the parameters listed, but alterations cannot be made from this connection. If a parameter needs to be altered this can be done from the PS100 Block and Parameter screen (see section 8.9.6), or by using the Paktester setting tool directly at the actuator.

(This page is intentionally blank)

13 COMMISSIONING THE SYSTEM

IMPORTANT SAFETY PRECAUTIONS

- In order to fully commission the Pakscan Loop it is necessary to ensure that all the system's valves are allowed to be opened and closed. Also any ancillary devices such as pumps and stirrers must be allowed to operate. Without this capability it is impossible to check all the functions of the total system.
- It may be that valve movement and pump operation is not permissible, as the plant may already be operational in a manual mode. In this case it will only be possible to test out parts of the Pakscan system. However if the connected field units are to operate devices on a 'live' plant it is vital to secure the connected equipment into a safe state. Ensure that the connected actuators are in Local control or locked in 'Hand' (as this will prevent them from moving under Pakscan control) and any other plant equipment connected to field units is either able to be operated safely, or that the outputs are prevented from operating the connected equipment.
- Don't forget that an actuator set to Local will still respond to an ESD signal and may move the valve. It is also advisable to ensure that all the connected equipment is safe, for example in Local Stop, whenever the loop is re-configured.
- The plant should only be returned to its original state once the loop is operating correctly.

BEFORE YOU START

- Ensure all the measurements and checks described in section 7.4 have been carried out. When the loop resistance and capacitance was measured the operating loop baud rate was determined. This baud rate must be set as the operating speed for ALL the connected field units. Note that the 'Doubling' option described in 9.3 above is an independent function, the cable parameters and number of field units present determine the baud rate selection.
- Set all the field units to match the master station Loop Baud Rate.

13.1 Checking Individual Field Units.

Use a Paktester to verify that each and every field unit is correctly set for Baud rate and Address. Where there are options for the setting of the field unit make sure these are adjusted correctly. Refer to the Paktester manual (S178E) for information regarding these adjustments. All field units, including those simply used for full open and full close duty, report analogue values for valve position. Whenever this data is not required, the Analogue Update Time and Deviation settings should be set to switch off this reporting, or to the maximum acceptable value. If these parameters are not correctly set then the field unit will be sending analogue messages far too often and slow down the remaining data communication on the loop.

Pay particular attention to selecting the correct function for General Purpose field units, and also for the settings for Analogue Update times and Deviation settings for all field units where analogue data is collected as mentioned above.

Make sure that no two field units on the loop have the same address, and that no field unit has an address set higher than that selected as 'the highest address' - see section 9.3.

When setting and checking a field unit remember that the Paktester will only communicate to one field unit at a time, the one to which it is connected. Also remember that the address and baud rate can only be altered if the field unit is in loopback.

13.2 Checking the Loop Itself

The most common problem in commissioning is that the field wiring is incorrectly made. If the cable is not connected correctly between the Output side of one field unit and the Input side of the next then the loop will fail to operate. As powered 'off' field units divert the signal directly from input to output a simple resistance check will not reveal this cabling error. Similarly if the cable is 'twisted' so that the common wire is not connected to all the common terminals this will also not be revealed by a simple resistance check.

It is extremely important to check all the wiring to ensure it is correctly connected throughout the loop.

Hint:

The loop wiring can often be checked by using a Paktester attached to one the end of the cable, then power 'on' all the actuators and successively power them 'off' starting with the one nearest the master station. The Paktester manual (S178E) has an illustration showing how to connect the Paktester.

This is only possible if the total loop resistance is **less than 200 ohms**.

Disconnect the loop wiring from the master station; connect the Paktester to the wires that were connected to Port A of the master station. Ensure that all the actuators are switched on. The Paktester should be able to establish communication with the nearest field unit to the master station. Once communication is verified, switch off the nearest field unit, and repeat the communication test with the next field unit. Successively power 'off' each field unit 'forwards' round the loop until communication has been verified with all the field units. Make a note of the order of the addresses of the field units on the loop (i.e. a Map).

Establishing communication in this way verifies the loop cabling, except for the final connection from the last field unit back to Port B of the master station. To check this final part of the wiring connect the Paktester to Port B wires (ensuring the correct polarity) and establish that you can communicate with the field unit nearest Port B.

❑ Checking the Loop with the Master Station

Initially set the Loop Driver circuits to deliver maximum loop voltage. Do this by turning the two potentiometers fully anti-clockwise.

Connect Port A wiring only to the master station and leave Port B disconnected. This time make sure that all the field units except the one furthest away are powered off. Select the Master Station Status screen, go to the Master Station Commands screen, and Reset the Loop by pressing '1'. Return to the Status screen (by pressing 'Menu').

The status screen will show 'Waiting for Loopbacks 1', and be followed by 'Finding FCU A', 'Finding FCU B', 'Waiting for Loopbacks 2', 'Loopbacks Off A', 'Loopbacks Off B' and finally 'Loopback On'. Now press '1' to select the master station commands, followed by '4' to select the diagnostic screen. This is illustrated in section 8.7.4. If all is well on the loop it should show that the reason for the last loop configuration is 'Reset Command' and that there is a loopback at the last field unit.

As the master station progresses through the configuration of the loop it moves through a number of steps:

1. It waits for all field units to revert to loopback on. - Waiting for Loopbacks 1
2. It locates each field unit connected to port A - Finding FCU A
3. It locates each field unit connected to port B - Finding FCU B
4. It then waits again for all field units to revert to loopback on - Waiting for Loopbacks 2
5. It removes loopbacks from field units on A as far as the last one on the loop, which it leaves in loopback - Loopbacks Off A
6. It removes loopbacks from field units on B as far as the last one on the loop, which it leaves in loopback - Loopbacks Off B
7. It reports the loop status - Loopback On or Off

The master station should have established communication with the furthest field unit. Return to the Master Station Status page (section 8.5), press 2 to select Field Units, and select the address for the powered on field unit by using the 'Up' or 'Down' arrow key. The FCU status screen (as illustrated in section 8.9.1) will show if communication is established.

Now switch on the next nearest field unit, change the display to show its status using the 'Up' or 'Down' arrow key and check that communication is established with it and the last field unit. There is no need to reset the loop as this unit has been introduced between the master station and the field unit in loopback and communication with it should be quickly established. If there is a fault on the loop wiring this will prevent the master from communicating to this field unit.

Successively progress backwards round the loop powering 'on' each field unit and establishing communications. Faults should be corrected as you go. Switch the display between the field unit being checked and the Master Station Status screen to make sure that communications are satisfactory. If the master station fails to locate a field unit, or goes into the reconfiguration process use the diagnostic screens to establish why. Finally you will end up with all the field units in communication with Port A.

Next connect the Port B wires and disconnect the Port A wires, reset the loop and check that there is only one loopback at the field unit nearest Port A.

Finally re-connect the Port A wires, reset the loop and check that there are no loopbacks anywhere, and that all the field units are in communication with the master station. Verify that status changes in the field are reported to the appropriate field unit screen, and that commands can be issued to every field unit.

13.3 Checking System Performance

In section 9.3 it was recommended to set Baud Rate Doubling 'OFF'. Once the loop is up and running this may be changed to 'Doubling On'.

13.3.1 Setting the Loop Driver Voltages

In most systems it is not necessary to trim the loop driver card voltages to optimise the performance. However for maximum performance the voltages can be set to match the loop cable parameters. The ideal voltage depends on the loop resistance and the number of field units attached:

$$\text{Ideal Voltage} = \frac{\text{Resistance}}{50} + \frac{\text{No. FCU's}}{50} + 3 \text{ Volts}$$

The two potentiometers can be set by either of two methods.

❑ Method 1

Turn both potentiometers fully anti-clockwise. This sets the voltage to the maximum.

To set Port A's voltage. Disconnect the two wires from Port B and re-configure the loop. With the loop running, turn Port A's potentiometer RV101 clockwise until the A LED on the door just goes out. Then turn the potentiometer back slightly until the A LED is fully lit once more.

To set Port B's voltage. Reconnect the two wires at Port B, and disconnect the two wires at Port A. Re-configure the loop. With the loop running, turn Port B's potentiometer RV102 clockwise until the B LED on the door just goes out. Then turn the potentiometer back slightly until the B LED is fully lit once more.

Reconnect the two wires at Port A. Re-configure the loop and leave it running for a few minutes. Check that communication with all field units is satisfactory.

❑ Method 2

With the field units powered up the master station should be able to communicate to all of them once the loop has been configured. If communications are not fully established see Section 13.4 for fault finding hints.

The line drive voltage can now be set with the aid of an oscilloscope. Allow the master station to configure the loop and ensure all field units are in communication without any loopbacks.

Monitor across Port A loop wires and trim V_{max} down to V_{ideal} by adjusting Port A's potentiometer. (See Figure 40)

Remove Port A wires, allow reconfiguration to finish, again checking all field units are in communication with only one unit in loopback (which should be the one that was connected directly to port A). Monitor across Port B loop wires and trim V_{max} down to V_{ideal} by adjusting Port B's potentiometer. Remove the oscilloscope and replace the field loop wires and reset the loop.

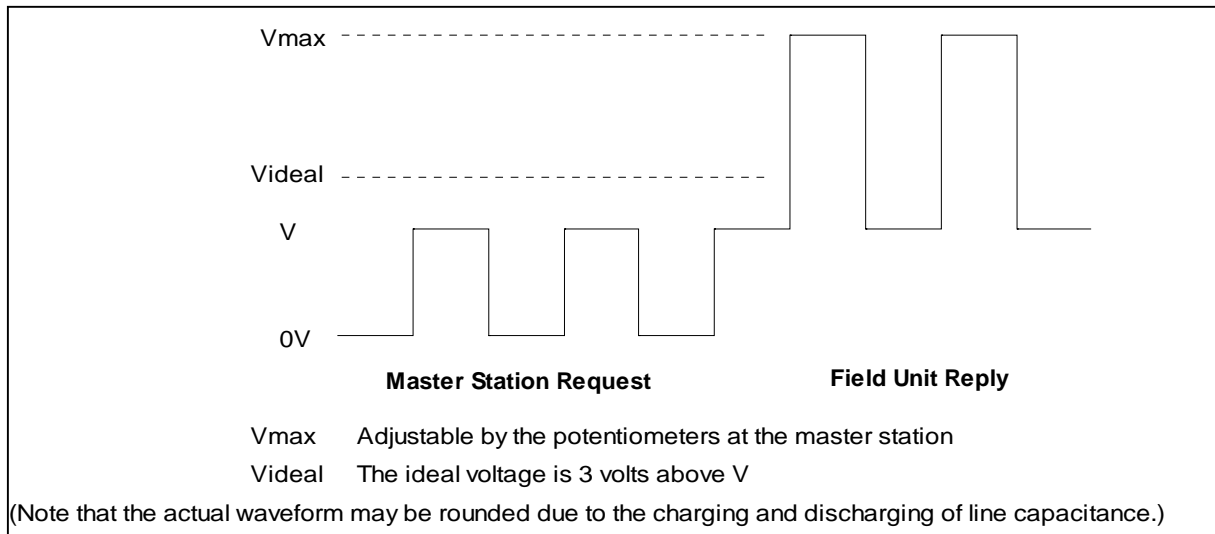

Fig 40: Idealised Loop Waveform, monitored at the master station

13.4 Diagnostic Information

The master station can provide information via its own display that can help in commissioning and fault finding.

13.4.1 Loop Configuration

The loop should configure with no loopbacks. If loopbacks are in use (as indicated by the master station status display), the loop diagnostic screen will indicate which field units have loopbacks asserted. The line fault will be at or between these units.

A code indicates the reason why loop configuration was last done. This can be useful if the system repeatedly carries out loop configuration, or fails to configure correctly.

The Port A and Port B LED's may help in indicating what is happening. At start-up or after a "Reset Loop" command the master station waits until it is sure that all the field units are in loopback. This time is about 10 seconds at 1200 baud. The Port A LED will come on when there is a complete current circuit. If it does not come on, there is a break near the Port A end.

The Port A LED then flickers as field units are found and their loopbacks removed. If the loop circuit is complete, normal scanning will then start as indicated by both LED's flickering together. The master station status will be reported as 'Loopbacks Off'.

If the loop continuity is incomplete, the master station switches to Port B after it has found all the field units connected to Port A. The Port B LED then flickers as field units are found there. Having found all the field units, the loop has to be left with loopbacks on the last-on-circuit field units only. This involves waiting for loopbacks to come on again, and then removing all of the loopbacks up to the field unit

before the loop fault. The Port A, then Port B LED's, flicker during this stage. Normal scanning of a broken loop shows up as both LED's flickering, but not together.

Should the setting of field unit parameters have been carried out incorrectly then the system will identify a field unit that has an address too high or duplicated with another and eliminate these from the routine data polling. They are marked in the data base as in error and their individual data screen displays show Comms Failure and Field Unit Fault.

13.4.2 Loop Communications

On a well-behaved loop, the error rate in communications with each field unit should be very low. The system should be Reconfigured, and once running successfully with no loopbacks present examine the FCU Map and Failure Counts screen (as shown in section 8.7.4.1).

This screen allows verification that the loop wiring follows the desired pattern. The screen shows both the physical position on the loop and the address of each field unit that is in communication with the master station. The screen also reveals a counter recording the number of failures in communications with each field unit. This counter records every error, including those that do not result in a communication failure alarm. (The alarm is only generated if the communication fails 3 times in succession), and it may be set to zero by the 'Clear' button.

In most systems communication errors will occur due to interference from associated plant. The main thing is that they should be relatively infrequent. Examining the counter, waiting a short while, and comparing the new value with the original is used to monitor the system performance. The counter only refreshes when the screen is first loaded, so to see changes it is necessary to leave and return to the selected screen. There should not be a significant change in the error count. If there is a large difference then it is an indication that there is a problem on the loop. This may be a cable fault (low resistance to earth for example), or that the loop is being run too fast for the cable fitted, or that a particular field unit is not functioning correctly.

If line errors cause problems the most likely causes are:

- (1) Twisted pair screen not earthed at master station
- (2) Twisted pair screen earthed at both ends
- (3) Twisted pair screen broken/not linked at field unit(s)
- (4) Line resistance too great
- (5) Line capacitance too great
- (6) Incorrectly adjusted loop voltages

13.4.3 Loop speed reprogramming

Problems can occasionally arise during loop speed reprogramming resulting in the loop being left with field units set at different speeds.

It is possible to recover from this situation by the following procedure:

- (1) Set the desired loop speed to that of the field units that the master station CANNOT talk to.
- (2) Re-configure the loop
- (3) Re-configure the loop again.

The master station should now be in communication with ALL the field units at the lower speed. Repeat the whole procedure if not. In some cases individual field units may need to be reprogrammed with a Paktester or IQ Setting Tool.

13.4.4 Checking Host Communications

If there are no communications between host and master station, check the diagnostic screen's 'Rx' and 'Tx' flags. Check the port setups at each end (baud rate, parity, etc.), and the cable connections between the two. These checks will usually succeed in getting messages going to and fro.

To assist in verifying that host communications are functioning correctly a simple screen is available that shows Modbus messages that have been received, and the validity of the messages. The 'Port Diagnostic Display' is available for Port 1, 2, and 3 (see section 8.7.2). The last Modbus message received is displayed together with the number of messages and an error count. Pressing the 'Load' button will update the screen to the latest information. Successive screen interrogations will reveal all the Modbus messages being sent to the master station. Pressing the 'Clear' button will reset the message counter to zero.

13.5 Final Checks

When the system is operating correctly use the following list to verify that everything has been covered.

Action	Done
a) Communication with every field unit and its operation has been verified
b) All jumper links on the master station and converter are correct
c) The loop parameters for highest address, baud rate and doubling are set
d) The Address set the same on the PS100 and the Ethernet link
e) Port 1 and 2 communications have been set, ESD actions have been set
f) The Security PIN and Access level has been set, tag names are entered
g) The Ethernet user passwords and bridge Mode have been set
h) The Ethernet LAN parameters have been set (IP address, Gateway etc.)
i) The Ethernet email and alarms have been set
j) The Comms Fail count for each field unit has been set to zero
k) The Port 1 and 2 Message count has been set to zero
l) The Clock has been set to the correct time and date
m) All the cards are screwed in place
n) The documentation record is complete

13.6 Commissioning Aids

Two handheld devices are available to aid commissioning and fault finding. The first is the Paktester, (Field Test Unit), that may be used to interrogate and control a single field unit via the 2-wire interface. This requires the disconnection of the field unit from a live loop. The Field Test Unit can also program various field unit parameters.

The second device is the Master Station Test Unit (or Pakreader), which communicates with a master station via the host serial links. Modbus discrete bits and registers may be read from and written to, allowing a master station and field units to be monitored and controlled.



Fig 41: Paktester

Fig 42: Pakreader

14 MASTER STATION SOFTWARE VERSION

The software version and type of the master station is displayed on the Top Diagnostic Display (8.7.1). A record should be made of this data, together with the serial number of the system, for future reference.

The serial number will be found on a data label on the rear of the unit.

The master station type includes a code as follows:

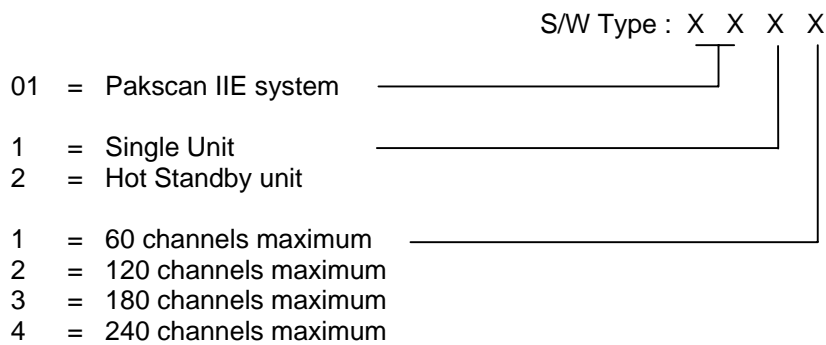

The version code is V: X.X, where digits following the V are the version number.

Both the V25 CPU and the Loop Driver cards have their own software. The version of software for these two processors must be compatible.

(This page is intentionally blank)

15 SET UP DATA RECORDS

A copy of the following table should be completed for every master station in the system. Keep the record safe so that in the unlikely event of a failure settings can quickly be restored when replacing a unit.

Master Station Setup Record:		
Master Station Modbus Address	Host	=
Master Station IP Address	Ethern	=
Protocol	Selected on Port 1	=
	Baud Rate	=
	Parity	=
Protocol	Selected on Port 2	=
	Baud Rate	=
	Parity	=
Alarms		= Linked / Separate
Security	PIN	=
	Access Level	=
Loop	Baud Rate	=
	Highest FCU address	=
	Doubling	= On / Off
	Retain data on comms loss	= Off / On
	IQ DV Convert	= Off / On
ESD	Serial Input	= Enabled / Disabled
	Keypad	= Enabled / Disabled
	Input terminal	= Enabled / Disabled
Tag Names	set	= Yes / No
Clock	set	= Yes / No
Software version	Main	=
	Loop	=
Ethernet	Admin User Name	=
	Admin Password	=
Ethernet	Netmask	=
Ethernet	E-mails	= On/Off
	Serial Number	=
	Supply Voltage	=

15.1 Loop Map

Complete the following chart showing the position and address and type of each field unit

Position	Address	Type
1		
2		
3		
4		
5		
6		
7		
8		
9		
10		
11		
12		
13		
14		
15		
16		
17		
18		
19		
20		
21		
22		
23		
24		
25		
26		
27		
28		
29		
30		

Position	Address	Type
31		
32		
33		
34		
35		
36		
37		
38		
39		
40		
41		
42		
43		
44		
45		
46		
47		
48		
49		
50		
51		
52		
53		
54		
55		
56		
57		
58		
59		
60		

For each field unit, record the settings made for the performance of the field unit.

Field units are of 3 basic types, IQ Actuator, Actuator and General Purpose. The settings that should be made are detailed in the Paktester manual. Use the following charts to note the settings for future reference. Alternately the records can be made automatically by connecting the MasterTools PC utility to the master station after commissioning the loop and saving the file created.

IQ Actuator Field Units

Actuator Type	Tag
Address	Baud Rate
Analogue Update Time	Analogue deviation Threshold
Motion Inhibit Time	Motion Inhibit Deadband
Torque Update Time	Torque Update Deviation
Torque Filter	Valve Travel Time
Auxiliary Mask (7)	(0)

 Actuator Field Units (Integral)

Actuator Type	Tag
FCU Type	
Address	Baud Rate
Analogue Update Time	Analogue deviation Threshold
Motion Inhibit Time	Motion Inhibit Deadband

 General Purpose Field Units (Actuator Mode)

Actuator Type	Tag
FCU Type	Mode Actuator
Address	Baud Rate
Analogue Update Time	Analogue deviation Threshold
Motion Inhibit Time	Motion Inhibit Deadband

 General Purpose Field Units (General Purpose Mode)

Tag	Actuator Man'fer/Type
FCU Type	Mode GP
Address	Baud Rate
Relay O/P mode	
An I/P 1 Deadband	An I/P 2 Deadband
An Report Timeout	
Digital Input Sense (8)	(1)

(This page is intentionally blank)

16 TECHNICAL SPECIFICATIONS

16.1 Master Station

Enclosure	19" rack to DIN41494 with rear terminals and connectors
Supply Voltage	90 to 264V ac, 43 to 440Hz, Fuse 1 Amp
Power Consumption	30VA for each master station module, 60VA for a hot standby master station
Current Loop	20mA 15V max, Pakscan protocol
Cable	Single twisted pair, 500 Ω max resistance and 3.9 μ F max capacitance
Field Units	240 max Actuator and General Purpose field units
Host Communications	(RS232 or RS485)
Connector	9 way D type
Protocol	Modbus RTU
Format	Asynchronous
Baud rate	1200, 2400, 4800, 9600, and 19200
Parity	Odd, Even, None or Always 0
Stop Bits	1
Host Communications	(Ethernet option)
Connector	RJ45
Protocol	Modbus TCP
Loop Connections	Screw clamp terminals suitable for 1.5 ² mm cables
Power Connection	IEC connector
Environmental Spec	Operating Temperature -10 to 60°C Storage Temperature -10 to +70° C Humidity 5% to 95% RH non-condensing
Relay Contacts	300 mA at 24V dc or 130 mA at 125V ac

16.2 Actuator Field Units

For data on field units fitted inside Rotork actuators refer to the actuator or field unit data sheets. The integral field units operate in the same environment as the actuator, using the actuator power supply and communicating commands and data directly with the actuator electronics.

16.3 GP Field Unit

Environmental Spec	Operating Temperature -30 to +70°C Storage Temperature -40 to +85°C
Power Supply	110V ac +/-20%, 240V ac +/-10%, 50/60Hz +/- 1Hz
Output Relays	2A, 130V, 60W, 125VA (exclusive maxima)

16.4 2-Wire Loop

□ Cables

The recommended cables to use for the loop wiring should be a twisted pair with an overall screen. The construction will usually be copper conductors and PVC insulation. There may be additional outer protection in the form of armour. This type of cable has a reasonably constant performance characteristic and the following is typical of the cable parameter data found from suppliers such as Beldon.

Cross Section (mm ²)	Resistance Ω/km @ 20 °C	Capacitance pF/m
0.5 solid	36.8 Ω/km	115 pF/m
0.5 flexible	39.7 Ω/km	115 pF/m
1.0 solid	18.4 Ω/km	115 pF/m
1.5 stranded	12.3 Ω/km	115 pF/m

□ Maximum Loop Distances

The cable resistance and capacitance must not exceed the permitted maximum values for each communication speed. The limiting values of C and R for each speed will depend on the number of field units actually connected. The following tables show the maximum values excluding the contribution from the field units themselves.

Maximum Resistance (ohms) of the Cable excluding field units	
Baud Rate	Number of field units
110 - 2400	0 to 240
	500

Note: 1 field unit has 1.14 ohms resistance

Maximum Capacitance (mF) of the Cable excluding field units					
Baud Rate	Number of field units				
	0	60	120	180	240
110	4.5	4.36	4.24	4.10	3.97
300	2.1	1.98	1.84	1.70	1.57
600	1.54	1.41	1.27	1.14	1.02
1200	0.6	0.47	0.34	0.20	0.07
2400	0.3	0.17	0.04	N/A	N/A

Note: 1 field unit has 2.2nF capacitance

From the cable data and the figures for the maximum permissible resistance and capacitance at each baud rate the maximum cable distances can be calculated for each baud rate. Note that the loop distance is the length of the twisted pair cable.

Loop Distance (km) with 1.5mm ² cable			
Baud Rate	Number of FCU		
	60	120	240
110	20.3 km	20.3 km	20.3 km
300	17.1 km	15.9 km	13.7 km
600	12.2 km	11.1 km	8.8 km
1200	4.1 km	2.9 km	0.6 km
2400	1.5 km	0.3 km	N/A

□ Scanning Time

The time to scan the loop, in seconds, for various baud rates, set up on the master station, with 32 FCU's, (doubling in action) is shown in the table. The times assume that only one field unit has data to report during the scan.

Scan Time (seconds)					
No. of FCU	Baud Rate				
	2400	1200	600	300	110
60	0.39	0.77	1.54	3.08	8.4
120	0.89	1.77	3.54	7.08	19.3
180	1.39	2.77	5.54	11.08	30.3
240	1.89	3.77	7.54	15.08	41.2

□ Command Time

The time taken for each command, from when the master station sends the command to when the field unit receives it is shown in the table (doubling in action). Commands are interleaved between poll messages, so a command is actioned almost immediately.

Command Time (milli-seconds)	
Baud Rate	Time (mSec)
2400	27
1200	54
600	108
300	216
110	432

The time for the feedback response to the command, e.g. change in digital status resulting from a motor starting, is:

1/2 loop scan time (typical)
 loop scan time (worst case)

Commands are sent individually to each actuator. Multiple commands require multiple messages.

16.5 External Connections

The following information applies to the connectors that are on the rear panel of the 19-inch rack.

16.5.1 Loop Connections and Digital I/O

Loop Connections and digital I/O are brought to terminal blocks and to a 25-way D-Type connector. There are two sets of terminals and connectors to support two master stations in the rack. If only one master station is fitted, or if the system is a "hot standby" type then the "master station A" terminal block or 25-way D-type must be used.

Notes:

1. ESD Input: The ESD input terminals should be linked for normal operation and disconnected to cause Emergency Shutdown, (providing that ESD is enabled).
2. Master station Main/Backup Inputs: In dual redundant systems, these inputs define which master station defaults to being the main unit, and which to being the standby unit.

Link Fitted	- Standby
Link Not Fitted	- Main
3. Terminals 18 to 21 are only used as described on the 'A' side
4. The alarm contacts shown, (terminals 1 to 9), are shown in the "powered off" state
5. Terminals 1 to 3 show the alarm contact state with a master station alarm. Terminals 4 to 9 show the alarm contact state with no field unit fault.
6. When using a hot standby master station both terminal blocks may be used, but only the NO contact will give a true indication of the alarm state.

Terminal Number & 25 way D-Type pin	Function
1	Alarm relay COM
2	Alarm relay NO
3	Alarm relay NC
4	New FCU alarm relay COM
5	New FCU alarm relay NO
6	New FCU alarm relay NC
7	FCU alarm relay COM
8	FCU alarm relay NO
9	FCU alarm relay NC
10	ESD input
11	ESD input common
12	Loop port A OUT
13	Loop port A IN
14	Loop port A screen
15	Loop port B OUT
16	Loop port B IN
17	Loop port B screen
18	Master station "A" main / backup
19	Master station "A" common
20	Master station "B" main / backup
21	Master station "B" common
22) Link 22 and 23 together if PS300
23) switch module is not fitted
24) Link 24 and 25 together if PS300
25) switch module is not fitted

Fig 43: External Connections to Terminals

16.5.2 Serial Ports

□ Serial Port 1 (the RS485 port)

Port 1 has a pair of 9-way D-type connectors, one male and one female. The connections are shown in the table.

The RS485 port has a true tri-state output allowing 2-wire communications to be used. The master station uses a 2-wire RS485 highway. If a 4-wire RS485 highway is needed this must be taken from Port 4 and a PS410 fitted in the rack.

The RTS signal is an output that is asserted when the system replies to a message. It can be used by RS485 repeaters or RS485/RS232 converters to switch between transmit and receive.

Port 1 – RS485	
Pin No.	Function
1	NC
2	NC
3	Data –
4	RTS –
5	Signal Ground
6	NC
7	NC
8	Data +
9	RTS +

□ Serial Port 2 (the RS232 port)

Port 2 is a single 9-way D-type female connector and uses RS232 hardware protocol. This port can be used as a data port, or for connection to a serial printer. The connections are shown in the table.

The CTS signal is an input to the master station that allows an external device to control the flow of data and is usually needed by a serial printer.

The master station is set up as DCE equipment, so there is no need to cross over pins 2 and 3 between the host and master station on the RS232 link.

Port 2 – RS232	
Pin No.	Function
1	NC
2	Receive
3	Transmit
4	NC
5	Signal Ground
6	NC
7	CTS
8	NC
9	NC

□ Serial Port 3 (the PS410 RS232 port)

Port 3 is a single 9-way D-type female connector and uses RS232 hardware protocol. This port can be used as a data port and is also configured as DCE.

Port 3 – RS232	
Pin No.	Function
1	NC
2	Receive
3	Transmit
4	NC
5	Signal Ground
6	NC
7	NC
8	NC
9	NC

❑ **Serial Port 4 (the PS410 RS485 port)**

Port 4 has a 9-way D-type female connector. The connections are shown in the table for both 2 and 4 wire connections. Internal links on the PS410 card select between 2 and 4 wire.

The RS485 port has a true tri-state output allowing 2-wire communications to be used. The master station uses a 2-wire RS485 highway. If a 4-wire RS485 highway is needed it must be taken from this port and a PS410 fitted in the rack.

The master station is a slave on the RS485 highway.

Port 4 – RS485		
Pin No.	2 wire Function	4 wire Function
1	NC	NC
2	NC	NC
3	Data –	Tx –
4	RTS –	Rx –
5	Signal Ground	Signal Ground
6	NC	NC
7	NC	NC
8	Data +	Tx +
9	RTS +	Rx +

❑ **Ethernet Port**

The Ethernet port uses a standard RJ45 socket for communication and is normally connected to a switch by a straight cable. If the port is used to connect directly to a PC then a cross over cable must be used.

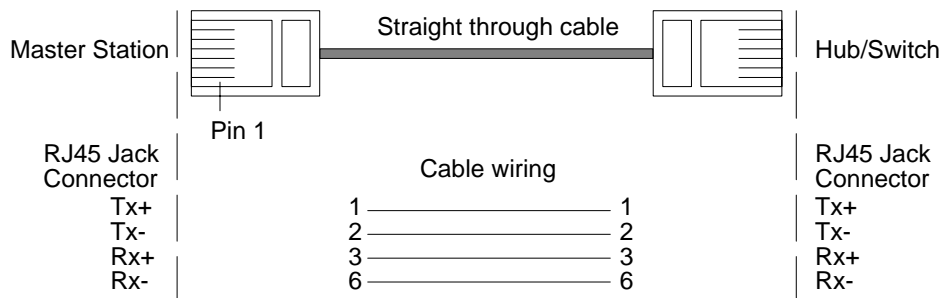

Fig 43: Connecting to a Hub or Switch

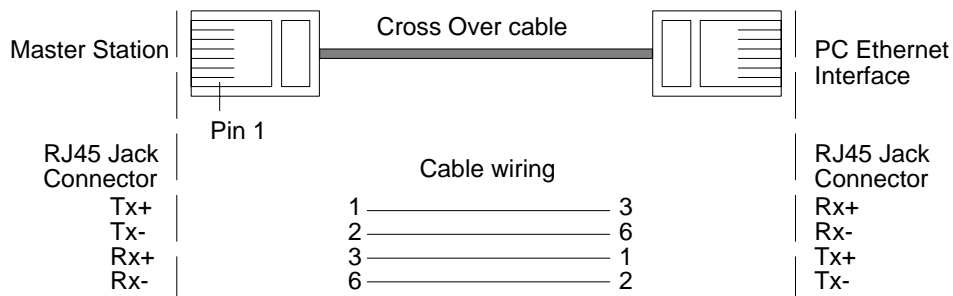

Fig 44: Connecting directly to a PC

16.6 Printer Messages

The master station can log alarm messages to a serial printer. Each message takes the form:

<Date> <Time> <FCU Address> <FCU Tag Name> <Alarm Text>

The alarm text printed will depend on the data bit from the comms link being present. The table shows the text printed and the associated data bit from the block and parameter in the data base. Block and parameter data is given in the Pakscan Modbus Interface Specification (Publication S171E).

Master Station Alarms	
All master station alarms are in Block 0 Parameter 0 of master station data base.	
Alarm Text	Alarm Bit
RAM Test Fail	8
ROM Test Fail	9
Reset Occurred	10
Auto-loopback Occurred	12

Field Unit Alarms	
All field unit alarms are in Block 3 Parameter 0 of the data base.	
Alarm Text	Alarm Bit
Memory Failure	0
Communications Failure	1
Control Not Available	2
Power On Reset	3
Watchdog Fail	4
Monitor Relay	5
Thermostat Tripped	6
Local Stop Pressed	7
Stop/Start Failure	8
Valve Jammed	9
Valve Obstructed	10
Manual Open	11
Manual Close	12
Manual Opening	13
Manual Closing	14
Motor Running – End Of Travel	15

Not all field units support all types of alarm

16.7 Maintenance

The Pakscan IIE master station is not suitable for field repair. Should the unit require maintenance contact your local Rotork representative.

❑ Battery Replacement

The master station contains a long life battery that should last for at least 3 years when no power is applied and considerably longer in normal use. Should the battery deteriorate a warning is displayed on the master station opening status screen. (The 'B' alarm may sometimes be generated on power on and can be cleared. This is normal for the unit.) The battery is used to retain the parameter settings and maintain the clock in the absence of mains power.

The battery is located in a holder on the main circuit board, it can be replaced by levering out the old battery and pressing in the replacement. In the absence of both the battery and mains power an on board capacitor will maintain the memory data for at least 5 minutes.

16.8 Master Station Dimensions

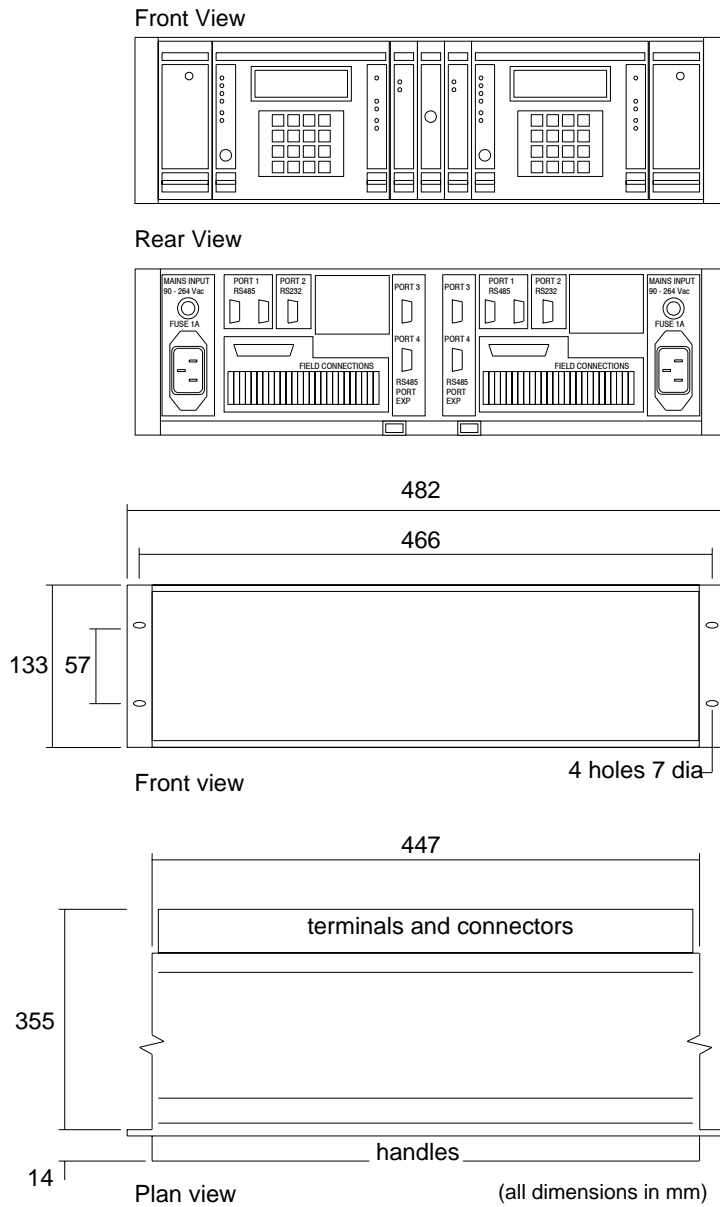

Fig 45: Pakscan IIE master station dimensions

Weight:	
Single master station	5.2 kg
Dual master station	6.8 kg
Hot Standby master station	6.9 kg

17 GENERAL SAFETY INFORMATION

Customer information regarding installation, user safety, environmental and electromagnetic compatibility

This information is provided to assist with conformance to the Health and Safety Act 1974 and various directives of the European Community.

❑ Mechanical

Care should be taken to avoid dropping heavy items - for example during installation or maintenance. Protective footwear should be worn when appropriate. Rotork products are not intended to carry the stresses involved in support of items supplied by others unless this has been specifically agreed to by the company.

Care should be taken to avoid contact with sharp edges or points, particularly if the product is partially dismantled.

❑ Electrical

Products should be installed in accordance with BS6739.

Electrical supplies and earthing should be in accordance with BS7671

Care should be taken to ensure that voltages or currents in excess of those specified, or of reversed polarity, are not applied to the terminals of any products. If such excess is applied, the product should be returned to Rotork or otherwise checked by a competent person before re-use, even if no damage is immediately evident. Use only the specified fuse type and rating as replacements.

Products should not be operated with safety protective covers removed, or with safety interlocks overridden. Some products are designed to allow access by skilled persons whilst power is applied. The user must control such skill level and access and it should be remembered that electromagnetic compatibility may be compromised.

Galvanically isolated input or output signal circuits are provided by certain products. A competent person must decide upon any earthing arrangements for such circuits and users should regard them as carrying a dangerous voltage, unless they are earthed locally.

❑ Batteries

Batteries must not be short circuited, or disposed of by burning. They must not be opened, punctured or crushed. Large batteries should only be used in well ventilated places. Their cases are generally ABS plastic resin and as such should be cleansed only with a damp cloth and not exposed to organic solvents.

❑ Electromagnetic Compatibility

To ensure conformance to the EC Directive 89/336/EEC, installation should adopt the following cable arrangements:

All digital data cables and all analogue signal cables operating at or below 50 Volts should be shielded either by braid, armouring or metal conduit.

Such shields should be earthed as closely as possible to the product. If for the avoidance of ground loops it is not possible to earth these shields locally at low frequencies, they should nevertheless be so earthed via a capacitor effective at radio frequencies.

A single shield may be shared by any number of analogue signal cables.

Functional Reliability

Reliability predictions, (including failure mode and effect analysis), are calculated by Rotork using statistical methods and the resulting figures should only be used for statistical purposes. These predictions are only valid if the maintenance procedures and maintenance intervals stated in Rotork documentation are observed.

Environmental

Products should only be operated within the environment specified on the product data sheet. Take care not to obstruct ventilation paths.

In the event of ingress of any fluid or spray, products should be immediately switched off, and cleaned and dried by a competent person before re-use.

Chemical

Specific hazards will be the subject of product data. As a matter of good working practice, oral contact should be avoided.

Independently Certified Products

Such products must not be modified in any way by the user, and must be applied, operated and maintained in accordance with the relevant standards, certificates and reports.

Product Data Sheets

These should be checked for information that supplements or replaces that given above.

(This page is intentionally blank)



<http://www.rotork.com>

Rotork reserves the right to amend and change specifications without prior notice.

Published data may be subject to change

UK Head Office

Rotork Controls Ltd
Bath
England
BA1 3JQ

Tel: +44 (0) 1225 733 200
Fax: +44 (0) 1225 333 467
e-mail: mail@rotork.co.uk

USA Head Office

Rotork Controls Inc
675 Mile Crossing Blvd
Rochester
New York 14624
USA

Tel: +1 716 328 1550
Fax: +1 716 328 5848
e-mail: info@rotork.com