

rotork

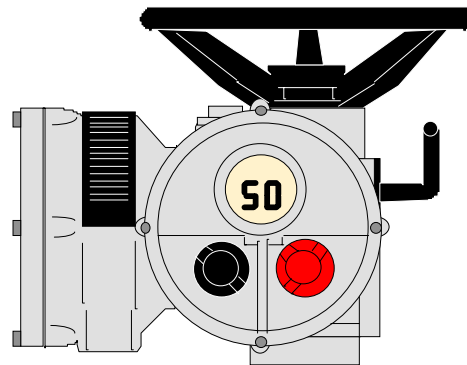
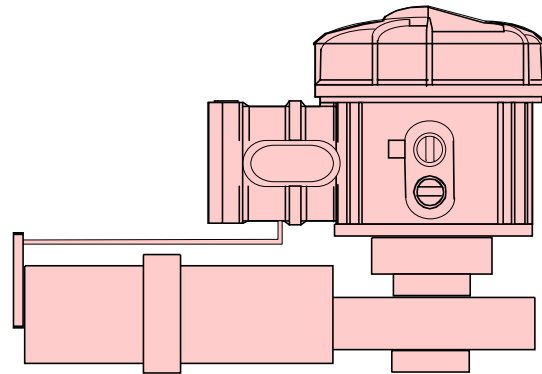
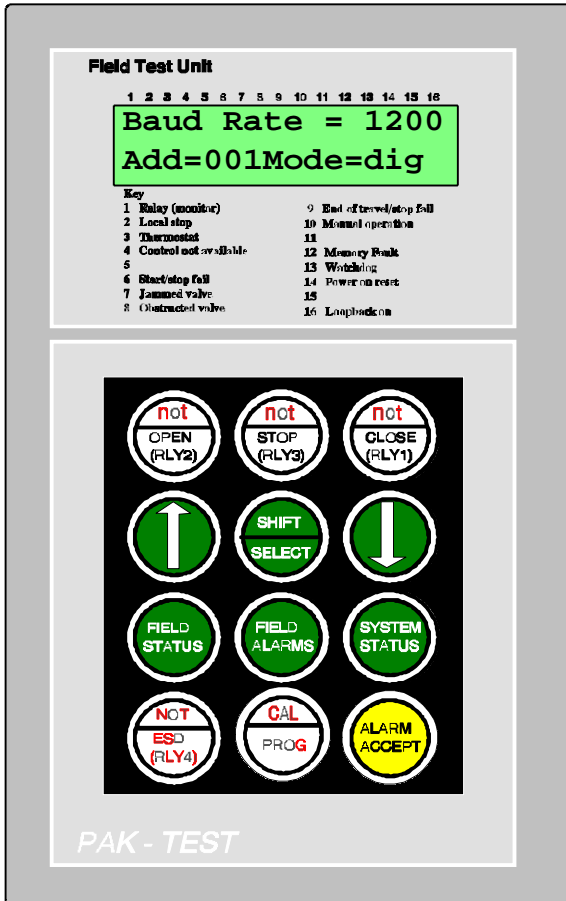
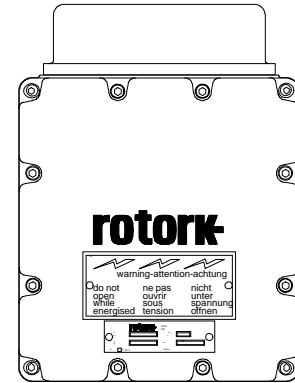

Pakscan Paktester (Field Test Unit)

Technical Manual

THIS MANUAL REPLACES THE PAKTESTER MANUAL R5161-016 AND RELATES TO PAKTESTERS FITTED WITH V5.0 FIRMWARE OR GREATER

Related Documents:

[1]	Pakscan Master Station Modbus Interface Specification	S171E
[2]	Pakscan IQ Field Unit Technical Manual	S172E
[3]	Pakscan Integral Field Control Unit Technical Manual	S173E
[4]	Pakscan General Purpose Field Control Unit Technical Manual	S174E
[5]	Pakscan IQ Analogue Input Field Unit	S164E

Abbreviations used in this document:

CA	=	Close Auxilliary Switch
CT	=	Close Torque Limit Switch
DV	=	Desired Value
ESD	=	Emergency Shut Down
FCU	=	Field Control Unit
FTU	=	Field Test Unit, - Paktester
GPFCU	=	General Purpose Field Control Unit
I1	=	Intermediate Auxiliary Switch 1
I4	=	Intermediate Auxiliary Switch 4
MV	=	Measured Value
NC	=	Normally Closed (contact)
NO	=	Normally Open (contact)
OA	=	Open Auxiliary Switch
OT	=	Open Torque Limit Switch

As we are continually developing our products their design is subject to change without notice

 The contents of this document are copyright and must not be reproduced without the written permission of Rotork Controls Ltd.

Contents

1. INTRODUCTION

2. OPERATOR INTERFACE

- 2.1. Liquid Crystal Display
- 2.2. Keypad
- 2.3. Operation

3. INITIAL POWER ON

- 3.1. System Status Display

4. PAKSCAN I DISPLAY MODES

- 4.1. Field Status Display (I)
- 4.2. Field Alarm Display (I)
- 4.3. Program Display (I)

5. PAKSCAN II DISPLAY MODES

- 5.1. Field Status Display (II)
- 5.2. Field Alarm Display (II)
- 5.3. Program Display (II)
 - 5.3.1. 1600 MkV, AQ and Q
 - 5.3.2. IQ
 - 5.3.3. GPFCU
 - 5.3.4. IQ Analogue Card
 - 5.3.5. Flowpak
- 5.4. Diagnostic Display (II)

6. TECHNICAL DESCRIPTION

- 6.1. General
- 6.2. Two-Wire Interface

7. MAINTENANCE

A APPENDIX

- A1 Paktester Options - Pakscan 1
- A2 Paktester Options - Pakscan 2 (Integral Actuator)
- A3 Paktester Options - Pakscan 2 (IQ Actuator)
- A4 Paktester Options - Pakscan 2 (GPFCU, Actuator Mode)
- A5 Paktester Options - Pakscan 2 (GPFCU, General Purpose Mode)
- A6 Paktester Options - Pakscan 2 (IQ Analogue Card)
- A7 Paktester Options - Pakscan 2 (Flowpak Actuator)
- A8 Use of Paktester with non-Actuator Field Units
- A9 Programming example
- A10 Examples of IQ mask

1. INTRODUCTION

This manual is based on a Paktester with an EPROM with a software version of V5.0 or higher. The software version of the EPROM is displayed on the second line of the display briefly after turning the Paktester on.

The Paktester is a hand held battery powered device designed to interrogate a Pakscan FCU via the 2 wire interface. It emulates the functions of a single channel master station to provide alarm and status information as well as giving valve operating commands.

Two protocols are supported, namely the earlier Pakscan I protocol and the current Pakscan II protocol, (which is faster and more flexible).

The Paktester can be used to operate various types of FCUs available including those specifically dedicated to the Pakscan I or Pakscan II loop protocols and also with the Integral type which can be supplied in either version.

The Paktester is used to program the following:

a/ - The address and baud rate for type 1 (digital control) Integral FCUs fitted to Rotork IQ, 1600 A Mk5, AQ Mk2, Q and Flowpak range actuators and all Pakscan II GPFCUs.

b/ - The above plus analogue report time and deadband along with motion inhibit time and deadband, for the type 3 (position control) FCUs.

c/ - All of the above plus additional parameters such as limited range positioning, valve travel time, torque filter factor, torque update timeout, torque deviation threshold and auxiliary input mask for the IQ FCU.

d/ - Item a/ plus the I/P scaling factors as well as the input type (current or voltage) for the IQ analogue card.

e/ - Items a/ and b/ for the GPFCU in actuator mode

f/ - For a GPFCU in GPFCU mode, item a/ plus the O/P mode of the relays, analogue report time and deadband, digital I/P mask, as well as I/P and O/P scaling factors can be programmed.

g/ - Items a/ and b/ plus the manual release pulse timer for the Flowpak FCU.

This manual describes the general operation of the Paktester and where relevant provides discrete sections relating to the applicable protocol. Knowledge of the protocol is unnecessary, but familiarisation with the particular type of Field Unit in use, (via a technical manual) is recommended.

Fig 1: Paktester connection

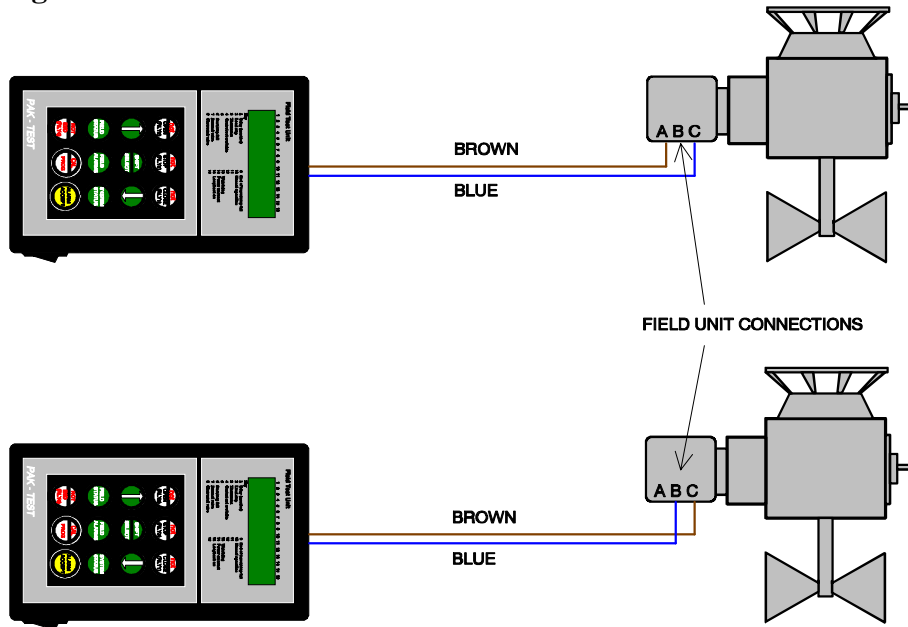

Connection to the Field Unit may be between the "A" and "C" terminals or between the "C" and "B" terminals, thereby allowing both loopback circuits to be tested.

Fig 2: Incorrect connection

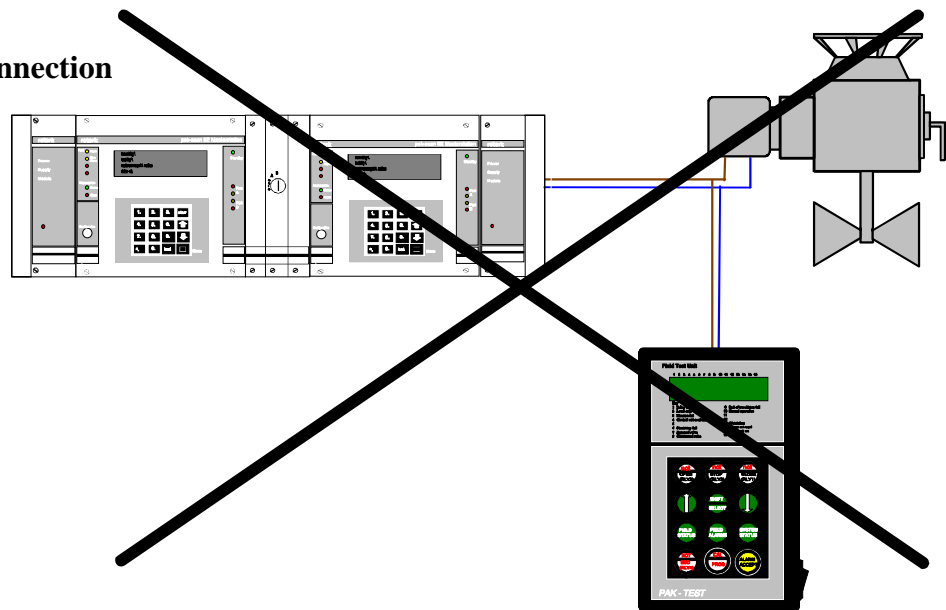

The master station must not be connected to the Field Unit whilst the Paktester is connected otherwise both units will attempt to generate loop current and the Paktester could be damaged.

2. OPERATOR INTERFACE

2.1. Liquid Crystal Display (LCD)

The Paktester is fitted with a dual line, 16 character LCD to provide the operator with the FCU status information.

Section 3 of this manual gives full details of the actual displays which vary according to the mode selected and the type of field unit connected.

The extreme right hand character in the lower row of the display is reserved for alarm indication, which is blank under non-alarm conditions but shows a flashing "A" when an alarm is active. The flashing "L" in the upper row indicates that the FCU is in loopback on mode. This is not an alarm condition as the FCU needs to be in loopback mode to provide a return path for the loop current.

User variables are highlighted by a flashing cursor, which when positioned over the selected parameter, may be altered by depressing the "up-arrow" or "down arrow" keys to achieve the required setting. Where several parameters are accessible on the single display, pressing the "SELECT" key moves the cursor to the next parameter.

Multiple page displays are accessed by repeated operation of the key(s) used to invoke the display.

2.2 Keypad

Brief descriptions of the key and key combination functions are shown in figure 3. **Note that some combinations are only enabled in certain modes, (e.g. CALibrate commands are not used in Pakscan I applications).**

The "SHIFT" key is used to select the "upper" functions on a number of other keys (e.g. "SHIFT" "PROG" selects the CALibrate mode where calibration data may be sent to the Field Unit. Generally "SHIFT" functions are less used than single key functions.

Where applicable the "SHIFT" key is used to "SELECT" a particular parameter on the relevant display to enable alteration etc.

2.3 Operation

When first powered up the Paktester displays the internal software reference and then performs a self test routine.

Failure during this test causes an error message to be displayed.

Successful completion of the self test enters the unit into the System Display mode.

Before communication with the FCU can be achieved, the following parameters need to be checked and re-set if necessary to accommodate the particular system.

These are:

	<u>Parameters</u>	<u>Default settings</u>
i)	Pakscan I or II protocol	Protocol = 2 (Pakscan II)
ii)	Applicable Baud rate	Baud rate = 1200
iii)	Appropriate FCU address.	Address = AU (auto)

Note: if items i) and ii) are correctly selected the FCU address can easily be ascertained by selecting AU (auto) for this parameter. When "loop back" has been established the FCU will communicate the correct address which then appears in the Paktester display.

Failure to display a valid address indicates an inability to communicate, therefore check FCU connections and items i) and ii) are correctly selected

Once communications are established the keypad may be used as described to select alternative display modes in order to monitor and control the FCU.

Fig 3: Key and key combination functions

	<p>NOT OPEN De-energise Relay 2 OPEN (RLY 2) Energise Relay 2 (OPEN) or increments "dv" in "position" mode</p>		<p>FIELD STATUS Displays Field Unit status</p>
	<p>NOT STOP De-energise Relay 3 STOP (RLY 3) Energise Relay 3, (STOP)</p>		<p>FIELD ALARMS Displays alarm information</p>
	<p>NOT CLOSE De-energise Relay 1 CLOSE (RLY 1) Energise Relay 1 (CLOSE) or decrements "dv" in "position" mode</p>		<p>SYSTEM STATUS Displays system parameters</p>
	<p>UP ARROW Increments the selected parameter indicated by the flashing cursor</p>		<p>NOT ESD De-energise Relay 4 ESD (RLY 4) Energise Relay 4, (ESD)</p>
	<p>SHIFT Selects the shift function of other keys. SELECT Selects the next user alterable parameter on this display</p>		<p>CAL Enter calibrate mode PROG Enter program mode</p>
	<p>DOWN ARROW Decrements the selected parameter indicated by the flashing cursor</p>		<p>ALARM ACCEPT Accepts displayed alarms and updates alarm status</p>

This page is intentionally blank

3. INITIAL POWER ON

The actual display presented to the operator is dependant upon ;

(a) the display mode selected at the keypad, and

(b) the protocol type applicable,

since the Pakscan II version supports a greater variety of FCUs and a wider range of data.

Details of the various display formats are given in the following sub-sections

3.1. System Status Display

Page one of the System Status Display allows the user to select the required protocol.



```
Select protocol
Pakscan 2
```

The second page of the System Status Display contains details of the basic Field Unit settings.



```
Baud Rate=1200
Add=001 Mode=dig
```

This allows the operator to alter the Baud rate, the FCU address and the mode of operation via the SELECT and UP/DOWN keys. It should be stressed here that values do not affect the FCU settings - they only alter how the test unit attempts to talk to the FCU.

The Baud rate may be selected as:

- 110 baud
- 300 baud
- 600 baud
- 1200 baud
- 2400 baud – (Pakscan II only)

The address may be in the range:

from 001 to 032 - Pakscan I & II FCUs

from 001 to 240 - Pakscan IIE & IIS FCUs

Mode may be "dig" (digital - on/off control)
"ang" (analogue - on/off control + analogue feedback)
"pos" (position - position control)
"gp" (general purpose field control unit)
"iqa" (IQ analogue I/P card)

Items "dig", "ang" or "pos" are actuator control options - selectable via the arrow keys. The "gp" option is fixed if the Paktester detects a GPFCU replying to it and the "iqa" option is fixed if the Paktester detects an IQ analogue card.

Page three of the System Status display indicates the type of FCU which the test unit has detected.

Field Unit Type=
IQ Actuator

or

Field Unit Type=
Q Actuator

or

Field Unit Type=
Ext Actuator

or

Field Unit Type=
General Purpose

or

Field Unit Type=
P-Pak Actuator

or

Field Unit Type=
???

4. PAKSCAN I DISPLAY MODES

Only traditional actuator controlling FCU's are explicitly supported by the Paktester in Pakscan I mode.

4.1. Field Status Display (I)

In digital mode the following actuator status information is available:

OA=1	OT=0	I1=0
CA=1	CT=0	I4=0

(OA = OAS, OT = OTLS, I1 = IAS1)

(CA = CAS, CT = CTLS, I4 = IAS4)

Code:- **0** = inactive i.e. not true
 1 = active i.e. true
OA = 0 or 1 flashing indicates valve opening
CA = 0 or 1 flashing indicates valve closing

In "analogue" and "position" modes the following actuator status information is available:

OA=1	OT=0	DVddd
CA=1	CT=0	MVmmm

(DV = desired value)

(MV = measured value)

Code:- **ddd** = **0 to 255 (pos mode)**
 = **xx** **(ang mode)**
mmm = **0 to 255 (pos & ang mode)**

i.e. intermediate auxiliary switch status (IAS1 and IAS4) has been replaced by the desired and measured values. In "position" mode the desired value may be altered using the OPEN and CLOSE keys. Measured values are not corrected for span and zero. In "analogue" mode DV is meaningless and the OPEN and CLOSE keys act as in "digital" mode.

4.2. Field Alarm Display (I)

The alarm display may take a number of formats depending upon alarm type present. During normal operation the display appears as follows;

```

RL      S      M      L
FIELD  ALARMS  A

```

As before, the "A" in the bottom right hand corner indicates an alarm which has not been accepted or is still active. The characters on the top row indicate via the key which alarms are active. This display covers all the actuator and FCU alarms.

If communications with the FCU are not established then "ALARM STATUS" is replaced by "COMMS FAILURE".

In the Paktester, a low battery condition is detected the message is replaced by "LOW BATTERY" and on memory test fail "SELF TEST FAILURE" is displayed on power-up.

All the fault codes are tabulated in table 1:

Note that GPFCUs and IQ analogue cards generate a subset of the actuator alarms and may be viewed in an identical manner. (Only "F", "W", "P" and "L" alarms are valid).

Position	Display	Meaning
1	R	Relay (monitor)
2	L	Local stop
3	T	Thermostat
4	C	Control not available
5		(reserved)
6	S	Start / stop fail
7	J	Jammed valve
8	O	Obstructed valve
9	E	End of travel / stop fail
10	M	Manual operation
11		(reserved)
12	F	Memory fault
13	W	Watchdog
14	P	Power on reset
15		(reserved)
16	L (flashing)	Loopback on

Table 1: Paktester fault codes

4.3. Program Display (I)

The Program Display, invoked by pressing "PROG", is used to change user alterable parameters in FCUs containing non-volatile memory (EEPROM). When the operating mode of the Paktester is set to "pos", (position control), the operator will be prompted to alter four parameters:

Baud Rate:

This is the rate at which data is transmitted around the loop. All devices on the loop as well as the master station should be set to the same rate.

Address:

This is the unique device identifier. Each device on the loop should have a unique address, which should also be no greater than the total number of FCU's that the master station can address.

Motion Inhibit Timer:

This sets the time between successive starts of the actuator and can be used to prevent the motor exceeding the rated number of starts per hour.

Deadband:

The deadband setting is used to prevent the actuator from hunting. Its value is dependent upon the speed of the actuator and the degree of accuracy required. Once the actuators position reaches the deadband it will stop the motor. However, if the actuator has a high speed it can overshoot the required setting and the actual stopping position could be outside the other deadband limit. It will then, after the time period set in the Motion Inhibit Timer, head towards the required setting again. If the control has to be exact then a small deadband, (2%), should be set, however, if a more tolerant control is permitted then a deadband of 5% would be acceptable.

N.B.

- 1/ **Not all FCUs carry EEPROM's and hence not all are programmable.**
- 2/ **A write protect link may need to be removed on the FCU to allow programming and re-fitted once programming is complete.**
- 3/ **Programming may be disabled if the FCU is not in loopback.**

When the Paktester is in modes other than position control the second page, (Motion Inhibit Timer and Deadband), is omitted.

The last page invites the operator to send the parameters to the FCU by pressing the up and down arrow keys simultaneously.

Once programming has been initiated the Paktester will ask the operator to wait whilst the parameters are downloaded. When this is complete the Paktester will interrogate the Field Unit to check the parameters. **It is the operators responsibility to ensure that correct programming has been carried out.**

This page is intentionally blank

5. PAKSCAN II DISPLAY MODES

All FCU's are supported by the Paktester in Pakscan II mode.

5.1. Field Status Display (II)

5.1.1 Actuator Field Status Display

In digital mode the following actuator status information is available:

OA = 1	OT = 0	I1 = 0
CA = 1	CT = 0	I4 = 0

(OA = OAS, OT = OTLS, I1 = IAS1)
(CA = CAS, CT = CTLS, I4 = IAS4)

Code:- **0** = inactive i.e. not true
1 = active i.e. true
OA = 0 or 1 flashing indicates valve opening
CA = 0 or 1 flashing indicates valve closing

(Note that with Pakscan II FCUs there is no torque limit switch and consequently OT and CT have no relevance).

In "analogue" and "position" modes the following actuator status information is available:

OA = 1	OT = 0	DVddd
CA = 1	CT = 0	MVmmm

(DV = desired value)
(MV = measured value)

Code:- **ddd** = 0 to 255 (pos mode)
= xx (ang mode)
mmm = 0 to 255 (pos & ang mode)

i.e. intermediate auxiliary switch status (IAS1 and IAS4) has been replaced by the desired and measured values. In "position" mode the desired value may be altered using the OPEN and CLOSE keys. Measured values are not corrected for span and zero. In "analogue" mode DV is meaningless and the OPEN and CLOSE keys act as in "digital" mode.

5.1.2. GPFCU Field Status Display

For actuator control FCU displays see section 3.2., GPFCUs are supported by the following additional displays;

Digital Inputs:

The first two pages show the state, "1" = active, "0" = inactive, of the eight digital inputs available on a GPFCU.

```
DIGITAL INPUTS
1=0 2=0 3=1 4=1
```

```
DIGITAL INPUTS
5=0 6=0 7=0 8=0
```

Digital Outputs:

Page three shows the operating mode of the digital outputs, (fleeting/maintained), and their status, ("1" = energised, "0" = de-energised).

```
DOUTS=FLEETING
1=0 2=0 3=0 4=0
```

Analogue Inputs:

Page four shows the analogue values, (0 to 100%), after calibration, measured at the two analogue inputs.

```
ANALOG INPUTS (%)
A=000.0 B000.0
```

Analogue Output:

The calibrated analogue output is displayed and may be raised/lowered by use of the up-arrow and down-arrow keys. Large changes to the analogue output may be made by using the "select" key to move the cursor to the tens column of the displayed value.

```
ANALOG OUTPUT
=000.0%
```

5.2. Field Alarm Display (II)

The alarm display may take a number of formats depending upon alarm type present. During normal operation the display appears as follows;

RL	S	M	L
FIELD	ALARMS		A

As before, the "A" in the bottom right hand corner indicates an alarm which has not been accepted or is still active. The characters on the top row indicate via the key which alarms are active. This display covers all the actuator and FCU alarms.

If communications with the FCU are not established then "ALARM STATUS" is replaced by "COMMS FAILURE".

In the Paktester, if a low battery condition is detected the message is replaced by "LOW BATTERY" and on memory test fail "SELF TEST FAILURE" is displayed on power-up.

All the fault codes are tabulated in table 2:

Note that GPFCUs generate a subset of the actuator alarms and may be viewed in an identical manner. (Only "F", "W", "P" and "L" alarms are valid).

Position	Display	Meaning
1	R	Relay (monitor)
2	L	Local stop
3	T	Thermostat
4	C	Control not available
5		(reserved)
6	S	Start / stop fail
7	J	Jammed valve
8	O	Obstructed valve
9	E	End of travel / stop fail
10	M	Manual operation
11		(reserved)
12	F	Memory fault
13	W	Watchdog
14	P	Power on reset
15		(reserved)
16	L (flashing)	Loopback on

Table 2: Paktester fault codes

5.3. Program Display (II)

The Program Display, invoked by pressing "PROG", is used to change user alterable parameters in FCUs containing non-volatile memory (EEPROM). When the operating mode of the Paktester is set to "pos", (position control), the operator will be prompted to alter various parameters:

5.3.1. Integral FCU – 1600 MkV, AQ MkII and Q FCU

Successful programming can only occur if the EEPROM write enable link on the FCU is removed and the FCU is in loopback. (The links are fitted only on the very early Pakscan II FCU boards – pre 1993). For optimum performance of the Pakscan loop, programming of Pakscan II FCUs the operating mode needs to be set to "pos" irrespective of whether the FCU is an ON/OFF, Analogue or Position controller.

Baud Rate:

This is the rate at which data is transmitted around the loop. All devices on the loop as well as the master station should be set to the same rate.

Address:

This is the unique device identifier. Each device on the loop should have a unique address, which should also be no greater than the total number of FCU's that the master station can address.

Motion Inhibit Timer:

This sets the time between successive starts of the actuator and can be used to prevent the motor exceeding the rated number of starts per hour.

Deadband:

The deadband setting is used to prevent the actuator from hunting. Its value is dependent upon the speed of the actuator and the degree of accuracy required. Once the actuators position reaches the deadband it will stop the motor. However, if the actuator has a high speed it can overshoot the required setting and the actual stopping position could be outside the other deadband limit. It will then, after the time period set in the Motion Inhibit Timer, head towards the required setting again. If the control has to be exact then a small deadband, (2%), should be set, however, if a more tolerant control is permitted then a deadband of 5% would be acceptable.

Analogue Timeout:

Sets the time period between successive updates of the analogue inputs over the two wire link. Note, if this time is set short the loop scan time will be extended by the additional analogue data being sent.

The recommended min value for “pos” FCUs is 10 x loop scan time or 30 seconds, whatever is the greater.

For ON/OFF i.e. “dig” FCUs set this value to 0

Analogue Deadband:

Sets the deviation allowed between the current analogue input and the previously reported value. When this deviation is exceeded a new analogue value is reported.

The recommended value for “pos” FCUs is 5%

For “dig” FCU’s set this value to 0

N.B.

1/ Programming may be disabled if the FCU is not in loopback.

2/ Some early Pakscan II FCUs were fitted with a write protect link that will need to be removed to allow programming of the FCU

When the Paktester is in modes other than position control the second page, (Motion Inhibit Timer and Deadband and Analogue Timeout and Deadband), are omitted.

The last page invites the operator to send the parameters to the FCU by pressing the up and down arrow keys simultaneously.

Once programming has been initiated the Paktester will ask the operator to wait whilst the parameters are downloaded. When this is complete the Paktester will interrogate the Field Unit to check the parameters. **It is the operators responsibility to ensure that correct programming has been carried out.**

5.3.2. IQ

In addition to the parameters described in section 5.3.1., the IQ FCU has the following further parameters which may be set via the Paktester.

Valve Travel Time

This sets the time that the centre column can continuously rotate before an alarm, (VTT), is generated. This should be set for a value greater than the valve travel time. A VTT alarm will not stop the centre column rotating.

Limited Range Positioning

It is possible to set the range of travel, in positioning mode, to be different to the 0% and 100% values corresponding to end of travel. This is used when the actuator normally only has to travel over a portion of its complete range. When set, the position value returned over the 2 wire loop will correspond to the % open between the set positions. If the actuator is used in digital mode, it will travel between its true 0% and 100% values.

Auxiliary I/P Mask

The IQ FCU can accept 4 external I/P's, called AUX1-4, either in the form of digital signals from level switches etc to be fed back to the master station via the 2 wire loop, or as remote pushbutton I/P's to control the actuator. AUX1-4 each have two bits associated with them, a function bit, (bits 5-8), and an invert bit, bits 1-4). When bits 5-8 are set to 0, AUX1-4 are used as digital I/P's to be sent to the host. Bits 1-4 are then used to condition the signals, i.e. they can be transmitted to the master station either in their true state, (with relevant bits set to 1), or inverted, (with bits set to 0). With bits 5-8 set to 1, the actuator will accept the AUX I/P's as remote pushbutton control I/P's. In this case bits 1-4 determine whether the motor will be energised with a closed contact, (with relevant bits set to 1), or with an open contact, (with bits set to 0). For examples of mask settings see appendix A10, (page 80).

Torque Deviation Threshold

Sets the deviation allowed between the current torque and the previously reported torque values. When this deviation is exceeded a new torque value is reported. When set to zero the torque will only be transmitted when requested by the Paktester or master station, or when the timeout value is exceeded.

The recommended value is 00 when torque data is not required otherwise set to 5%

Torque Update Timeout

This is similar to the analogue timeout in that it sets the time period between successive updates of the instantaneous torque readings over the 2 wire loop. If this is set to zero the torque will only be transmitted when requested or when the deviation threshold is exceeded.

Torque Filter Factor

This relates to the 8 torque readings taken over the full travel of the actuator. With the filter set to 0 the raw torque data will be fed back to the master station. Filtering allows for an averaging of the latest readings with the historical torque readings. The filter may be set in the range 0 - 255 and gives a torque reading as follows;

$$\text{Reported value} = \left[\text{new value} \times \left(1 - \frac{\text{filter factor}}{256} \right) \right] + \left[\text{old value} \times \frac{\text{filter factor}}{256} \right]$$

Note on Torque reporting;

If torque data is not required for normal use it is recommended that automatic torque data reporting is turned off, i.e. deviation = 00, timeout = 000 and filter factor set to the factory default of 127. This will allow for a much faster loop scan time as the loop will not be congested with unwanted torque data. The torque will still be available for collection by the master station / host upon request.

When an IQ actuator is used on a loop controlled by a Pakscan 2 master station fitted with software less than V2.2, automatic torque data reporting must be turned off as the master station is unable to accept torque data.

5.3.3. GPFCU

a/ Programming

In addition to being able to be configured as actuator FCUs, GPFCUs have a number of additional programmable parameters when set to General Purpose mode;

Relay Output Mode:

Selects whether the relay outputs are fleeting or maintained contacts.

Analogue Input 1 Deadband:

Sets allowed deviation for analogue input 1, (see explanation in 5.3.1.).

Analogue Input 2 Deadband:

Sets allowed deviation for analogue input 2, (see explanation in 5.3.1.).

Analogue Report Timeout:

Sets update timeout for both analogue inputs, (see explanation in 5.3.1.).

Digital Input Mode:

Selects whether digital inputs are inverted or normal. A "0" indicates normal input mode, while a "1" is for inverted inputs. The left most digit represents Digital Input 8, the right most, Input 1. The "Select" key scrolls the cursor between digits. The down-arrow toggles the digit between 0 and 1. The up-arrow toggles all the digits simultaneously.

b/ Calibration

By pressing the <SHIFT> and <PROG> keys together the calibration mode is entered where certain fundamental parameters may be stored in the FCU. Continual pressing of the keys together causes the display to cycle through the various parameters outlined below.

Analogue Input 1, 0% Setting:

By pressing the up-arrow and down-arrow keys simultaneously. The FCU is instructed to store the current value pre-set on Analogue Input 1 as its 0% reference.

Analogue Input 1, 100% Setting:

Setting this causes the FCU to store the current value pre-set on Analogue Input 1 as its 100% reference.

Analogue Input 2, 100% Setting:

As above for Analogue Input 1, 0% Setting.

Analogue Input 2, 100% Setting:

As above for Analogue Input 1, 100% Setting.

Analogue Output, 0% Calibration:

This parameter, accessible using the arrow keys, sets the 0% calibration point for the analogue output. This can be set in practice by setting the required analogue output, via the field status display, to zero. This parameter may now be adjusted so that the analogue output is exactly 0V.

Analogue Output, 100% Calibration:

This parameter sets the 100% calibration point for the analogue output. This may be adjusted by setting the required analogue output to maximum and then adjusting the calibration constant so that the desired output voltage is measured at the FCU.

5.3.4. IQ Analogue Card

The IQ Analogue card sits inside an IQ actuator between the FCU and the main PCB. It is a separate node on the Pakscan highway and as such must be programmed with its own unique address and the loop speed (see section 5.3.1.)

The card is designed to feed two external analogue, 4-20mA or 0-5V signals via itself onto the Pakscan loop and on to the master station. It has the same programme analogue I/P options as the GPFCU (see section 5.3.3.). The only additional programmable feature is:

Analogue Input Signal:

The Analogue I/P card has two independent inputs. The choice of I/P signal (4-20mA or 0-5V) is configurable. I/Ps 1 and 2 do not have to be set to the same type of I/P signal.

5.3.5. Flowpak

The Flowpak has the same programmable settings as the Integral FCU (see section 5.3.1.) plus two additional options:

Actuator Speed:

This parameter selects the time needed by the FCU to detect that the actuator is moving by looking at the potentiometer feedback. There are three settings:

- SLOW i.e. < 4 sec,
- NORMAL i.e. between 4 and 12 sec
- FAST i.e. > 12 sec

If a coil has been energised and the potentiometer feedback hasn't changed by more than 1% within the time period programmed, the FCU will declare that the valve has jammed.

Manual Release:

The Flowpak has a manual control override feature. If the actuator is closed and an open command is requested, a close command is initially sent to release the manual control, followed by a delay period equal to the manual release time, before the open command is sent. (The opposite is true if the actuator were at the open limit). This delay period allows the hydraulic fluid to stabilise between the two conflicting commands.

5.4. Diagnostic Display (II)

By pressing the <SHIFT> and <FIELD STATUS> display keys simultaneously, diagnostic data from the FCU may be examined.

The first page allows access to data from any block and parameter (see Pakscan Master Station Modbus Interface Specification – S171E, for reference) in the FCU. When in this mode the Paktester polls the FCU for data and, if available, displays it in hex format.

Page 2 displays the data, (in hex), and block number of the most recently reported exception data from the Field Unit.

6. TECHNICAL DESCRIPTION

6.1. Power Supply

The Paktester is designed to run of a nominal 9V dc battery (PP3). The unit will operate over the range 6V to 11V but will indicate "low battery" below 7V.

6.2. Two-wire Interface

The Paktester provides the 20mA drive necessary to power the line up to a maximum of 5V. The line current is switched on prior to transmission and off when reception is complete in order to prolong battery life. Two wires are provided carrying the current out of (brown) and into (blue) the Paktester. The output is short circuit and over voltage protected in case of incorrect connection.

In order for the Paktester to be able to communicate with a FCU, the current loop must be complete. (Note, for the Paktester to automatically determine the FCU address the correct Baud rate must be set and the "ADDRESS" must be set to AU. To re-programme the FCU it must have entered loopback.)

Since the Paktester has limited drive capability it will only drive a line resistance of up to 250 Ohms. It may still however be used to test FCU's by connecting to the master station field wiring in the control room, if only one unit is powered up at a time. In this case the Paktester will only be able to communicate with the first powered FCU on the loop. Once tested this unit may be powered down and the next unit tested and so on. This method has the benefit of testing both the FCU and the wiring.

7. MAINTENANCE

All units are subjected to stringent inspection and test procedures during manufacture to ensure maximum reliability.

No routine maintenance, other than battery replacement, is required.

In the event of a suspected malfunction we recommend that due to the complexity of the unit it should be returned to Rotork Controls for checking/repair.

This page is intentionally blank

APPENDIX

A 1/1 PAKTESTER OPTIONS – PAKSCAN 1 (INTEGRAL ACTUATOR FCU'S)

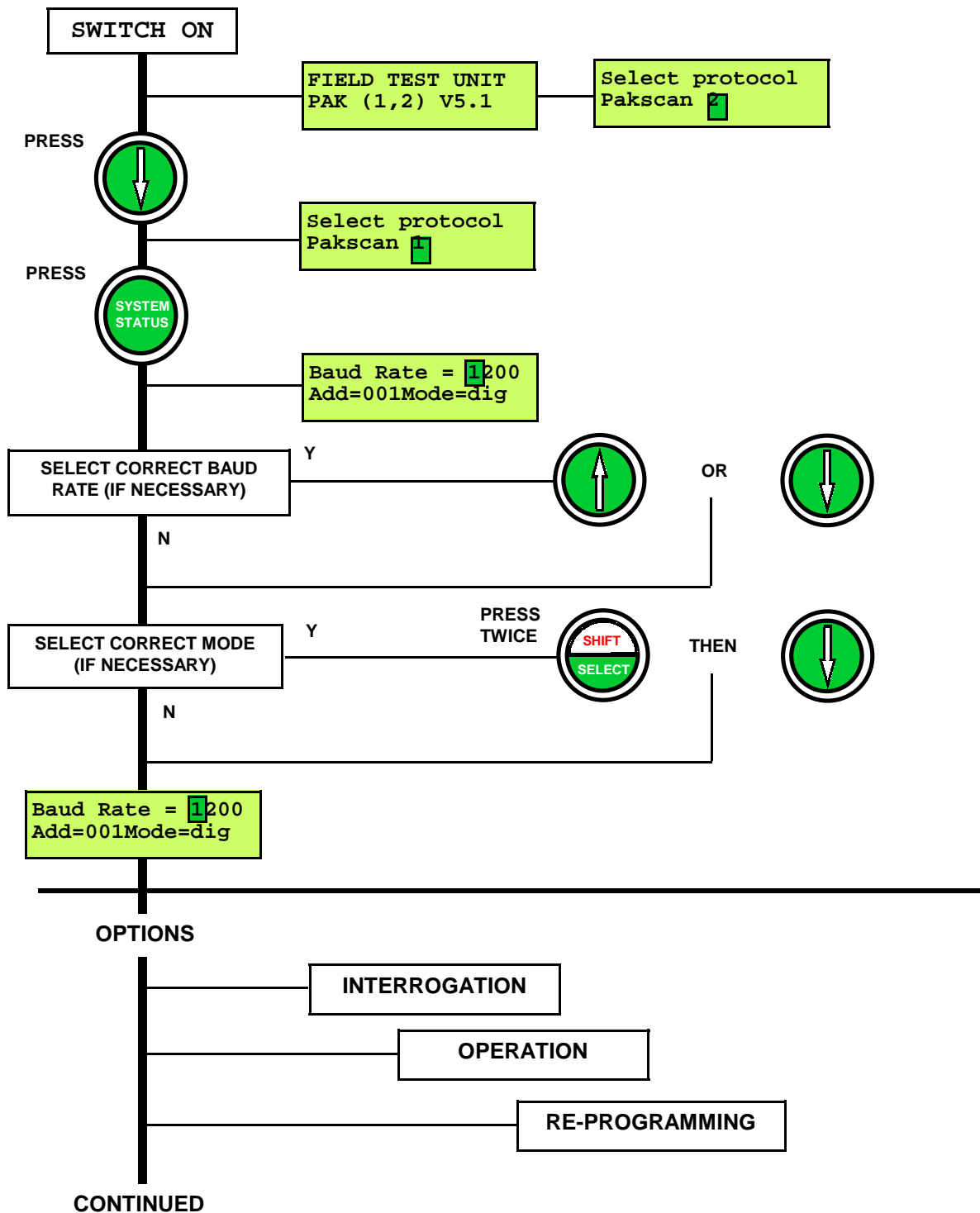

Baud Rate = 1200
Add=001Mode=dig

A 1/2

INTERROGATION

ALARM DISPLAY

PRESS



RL S M L
FIELD ALARMS A

TO ACCEPT ALARM

PRESS



Position	Display	Meaning
1	R	Relay (monitor)
2	L	Local stop
3	T	Thermostat
4	C	Control not available (reserved)
5		(reserved)
6	S	Start / stop fail
7	J	Jammed valve
8	O	Obstructed valve
9	E	End of travel / stop fail
10	M	Manual operation (reserved)
11		(reserved)
12	F	Memory fault
13	W	Watchdog
14	P	Power on reset (reserved)
15		(reserved)
16	L (flashing)	Loopback on

FIELD STATUS

PRESS



DIGITAL (TYPE 1)

OA=0 OT=0 I1=0
CA=1 CT=0 I4=0

POSITIONAL (TYPE 3)

OA=0 OT=0 DVddd
CA=1 CT=0 MVmmm

Code	Description
OA	Open Limit Switch
CA	Closed Limit Switch
OT	Open Torque Limit Switch
CT	Close Torque Limit Switch
I1	Motor Stopped (Between limits)
I4	Motor Running
DV	Desired Value
MV	Measured Value

OPERATION

OPEN



STOP



CLOSE



ESD



CONTINUED

Baud Rate = 1200
Add=001Mode=dig

A 1/3

RE-PROGRAMMING

RE-PROGRAMMING TYPE 1 FCU

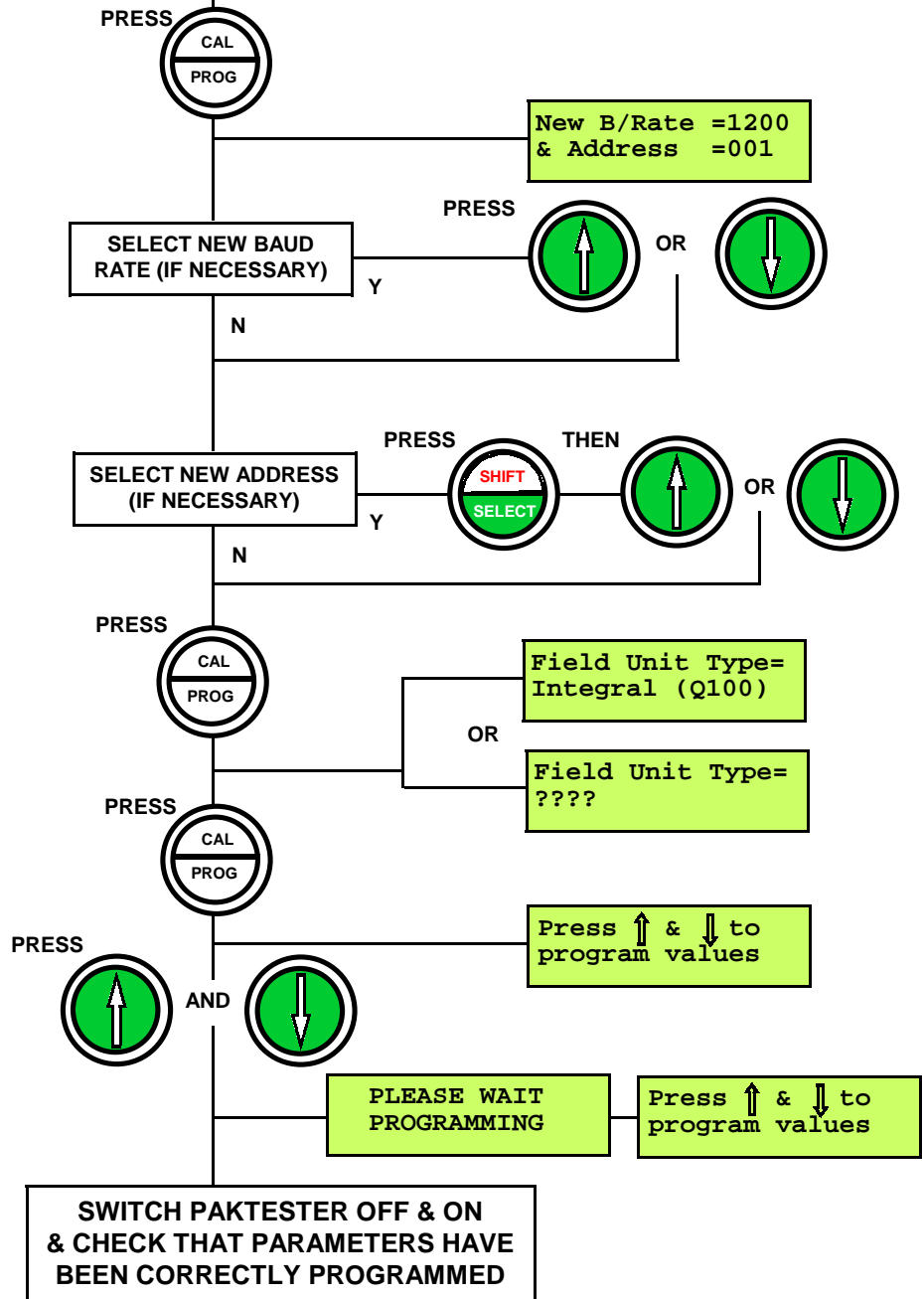

CONTINUED

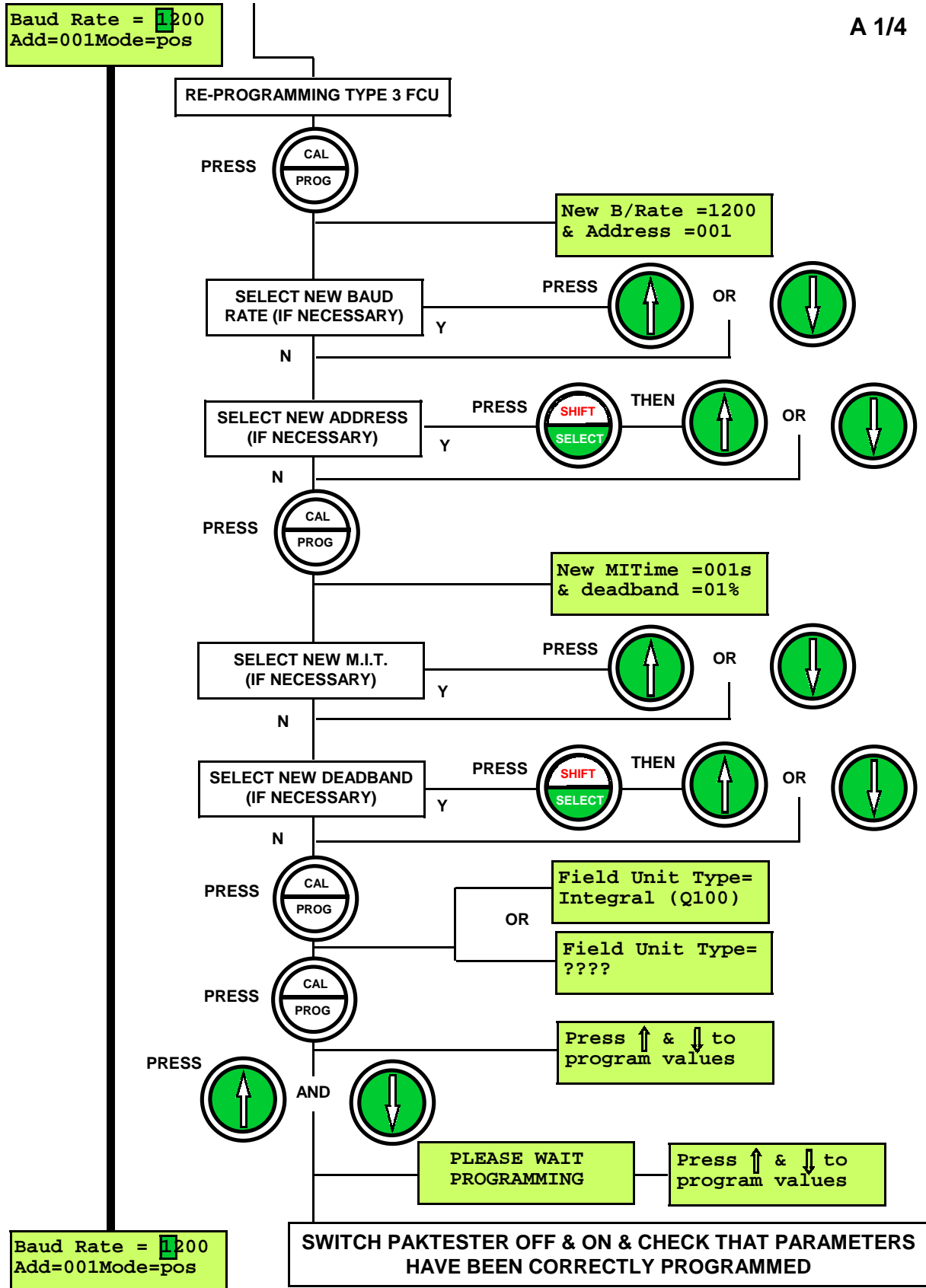

A 2/1 PAKTESTER OPTIONS – PAKSCAN 2 (INTEGRAL ACTUATOR FCU'S)

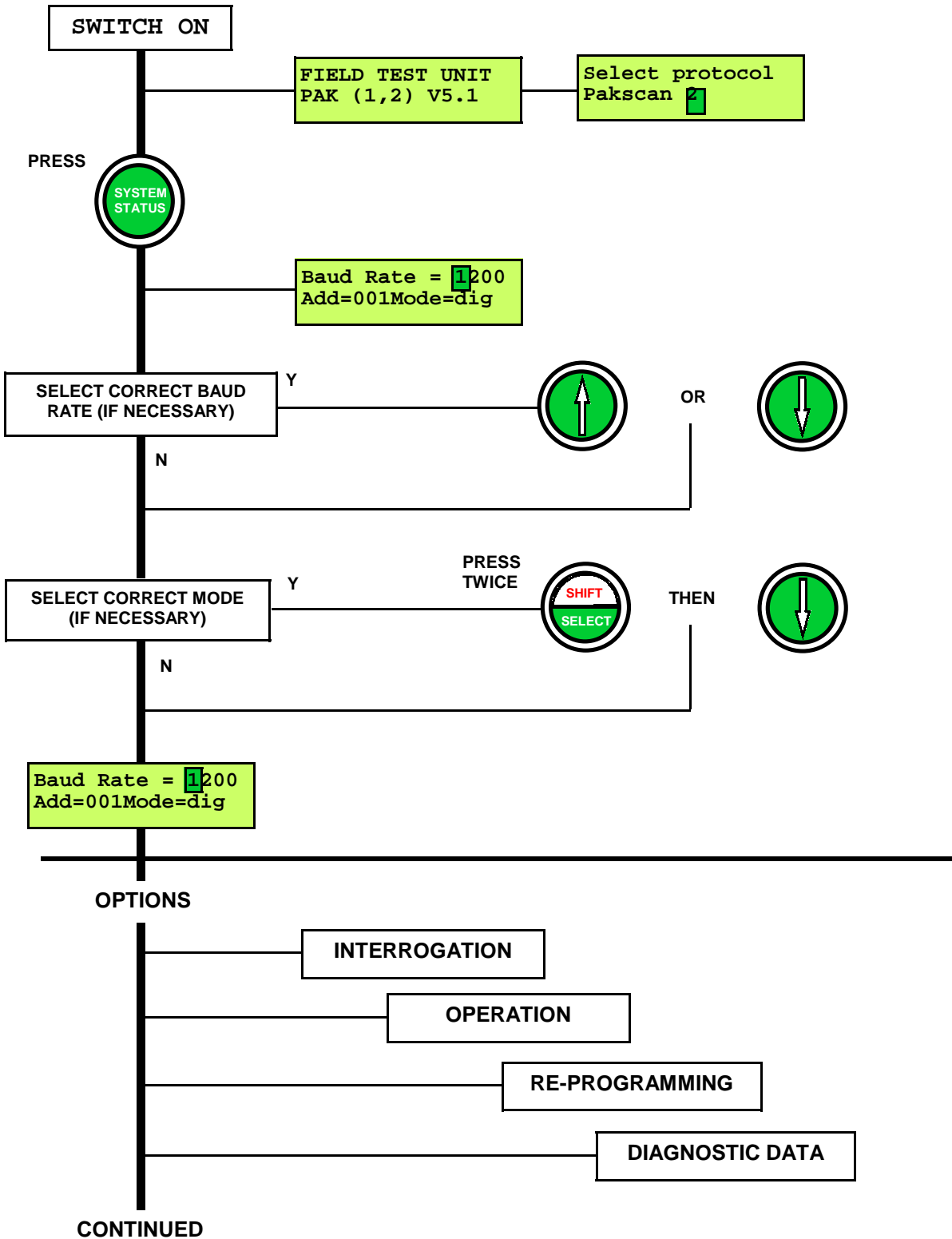

Baud Rate = 1200
Add=001Mode=dig

INTERROGATION

ALARM DISPLAY

PRESS



RL S M L
FIELD ALARMS A

TO ACCEPT ALARM

PRESS



Position	Display	Meaning
1	R	Relay (monitor)
2	L	Local stop
3	T	Thermostat
4	C	Control not available (reserved)
5		
6	S	Start / stop fail
7	J	Jammed valve
8	O	Obstructed valve
9	E	End of travel / stop fail
10	M	Manual operation (reserved)
11		
12	F	Memory fault
13	W	Watchdog
14	P	Power on reset (reserved)
15		
16	L (flashing)	Loopback on

FIELD STATUS

PRESS



DIGITAL (TYPE 1)

OA=0 OT=0 I1=0
CA=1 CT=0 I4=0

POSITIONAL (TYPE 3)

OA=0 OT=0 DVddd
CA=1 CT=0 MVmmm

Code	Description
OA	Open Limit Switch
CA	Closed Limit Switch
OT	Open Torque Limit Switch – Pak 1 only
CT	Close Torque Limit Switch – Pak 1 only
I1	Motor Stopped (Between limits)
I4	Motor Running
DV	Desired Value
MV	Measured Value

OPERATION

OPEN



STOP



CLOSE



ESD



CONTINUED

Baud Rate = 1200
Add=001Mode=dig

A 2/3

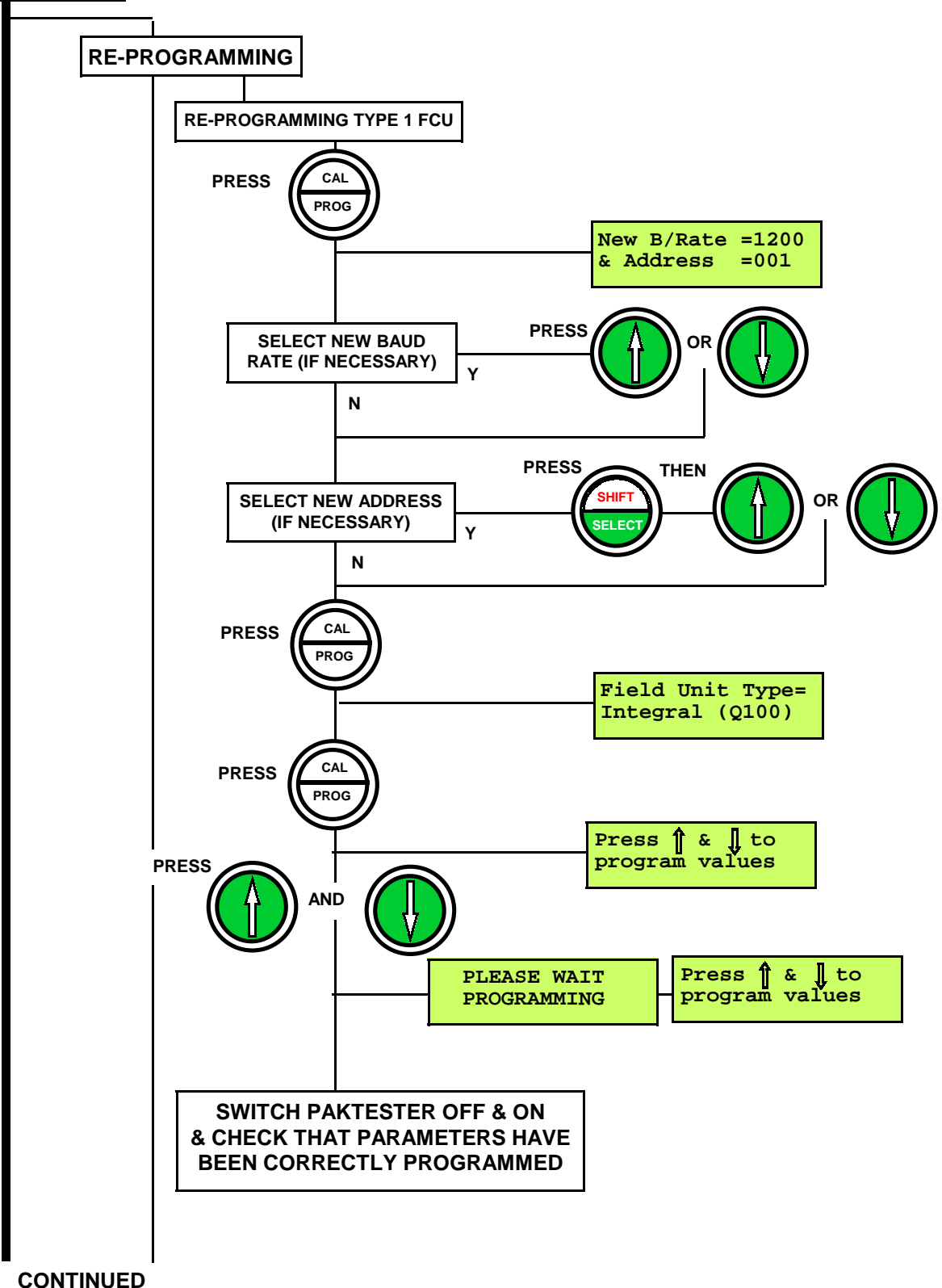

CONTINUED

Baud Rate = 1200
Add=001Mode=pos

RE-PROGRAMMING TYPE 3 FCU



PRESS 

New B/Rate =1200
& Address =001

SELECT NEW BAUD RATE (IF NECESSARY)

PRESS  OR 

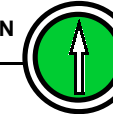
SELECT NEW ADDRESS (IF NECESSARY)

PRESS  THEN  OR 

PRESS 

New MITime =001s
& deadband =01%

SELECT NEW M.I.T. (IF NECESSARY)

PRESS  OR 

SELECT NEW DEADBAND (IF NECESSARY)

PRESS  THEN  OR 

CONTINUED

CONTINUED

Baud Rate = 1200
Add=001Mode=pos

A 2/5

RE-PROGRAMMING TYPE 3 FCU (CONTINUED)



Analog time=000s
& deadband =00%

SELECT NEW ANALOGUE
TIME (IF NECESSARY)

PRESS

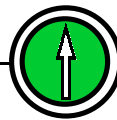

OR



N

SELECT NEW DEADBAND
(IF NECESSARY)

Y

PRESS



THEN

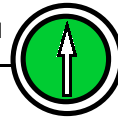

OR



N



Field Unit Type=
Integral (Q100)



Press ↑ & ↓ to
program values

PRESS



AND



PLEASE WAIT
PROGRAMMING

Press ↑ & ↓ to
program values

SWITCH PAKTESTER OFF & ON &
CHECK THAT PARAMETERS HAVE
BEEN CORRECTLY PROGRAMMED

CONTINUED

Baud Rate = 1200
Add=001Mode=pos

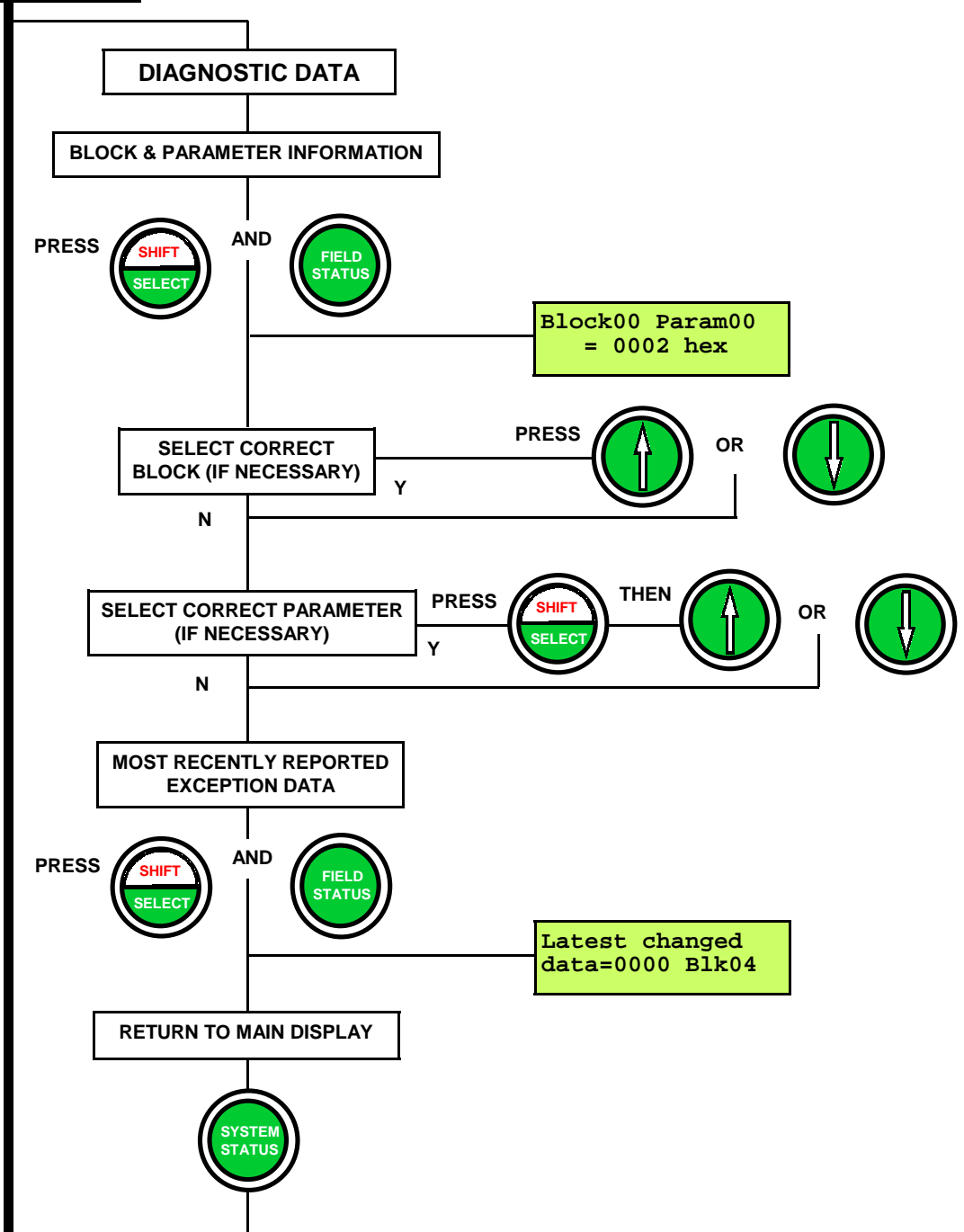

Baud Rate = 1200
Add=001Mode=pos

A 3/1 PAKTESTER OPTIONS – PAKSCAN 2 (IQ ACTUATOR FCU'S)

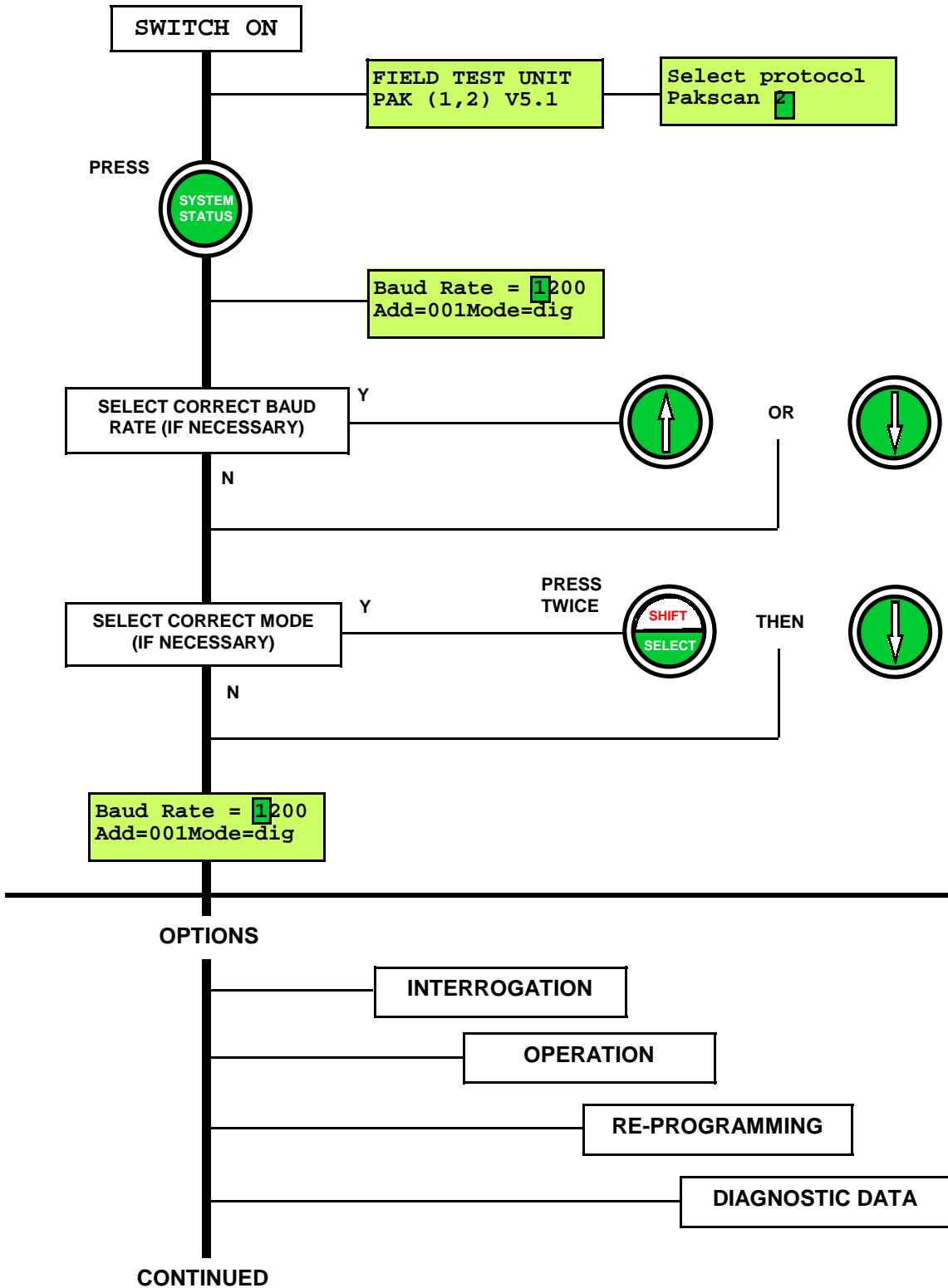

Baud Rate = 1200
Add=001Mode=dig

INTERROGATION

ALARM DISPLAY

PRESS



RL S M L
FIELD ALARMS A

TO ACCEPT ALARM

PRESS



FIELD STATUS

PRESS



DIGITAL (TYPE 1)

OA=0 OT=0 I1=0
CA=1 CT=0 I4=0

POSITIONAL (TYPE 3)

OA=0 OT=0 DVddd
CA=1 CT=0 MVmmmm

Position	Display	Meaning
1	R	Relay (monitor)
2	L	Local stop
3	T	Thermostat
4	C	Control not available
5		(reserved)
6	S	Start / stop fail
7	J	Jammed valve
8	O	Obstructed valve
9	E	End of travel / stop fail
10	M	Manual operation
11		(reserved)
12	F	Memory fault
13	W	Watchdog
14	P	Power on reset
15		(reserved)
16	L (flashing)	Loopback on

Code	Description
OA	Open Limit Switch
CA	Closed Limit Switch
OT	Open Torque Limit Switch – Pak 1 only
CT	Close Torque Limit Switch – Pak 1 only
I1	Motor Stopped (Between limits)
I4	Motor Running
DV	Desired Value
MV	Measured Value

OPERATION

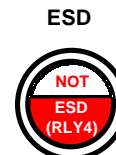

CONTINUED

Baud Rate = 1200
Add=001Mode=pos

A 3/3

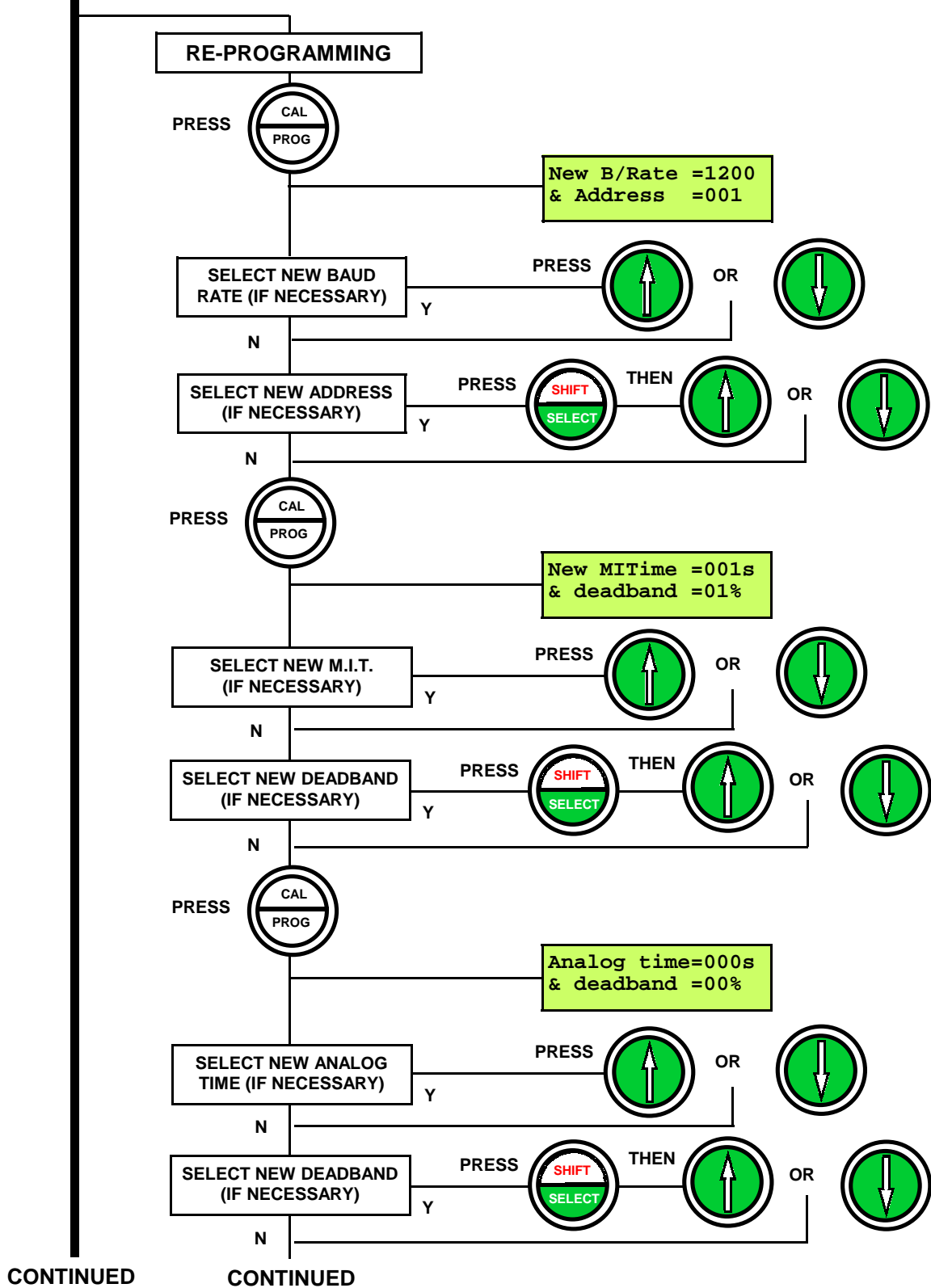

Baud Rate = 1200
Add=001Mode=pos

A 3/4

RE-PROGRAMMING (CONTINUED)

Analog time=000s
& deadband =00%



Valve travel
time = 1000

SELECT NEW TRAVEL
TIME (IF NECESSARY)

PRESS

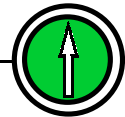

OR



Y

N



0% cal = 000%
100% cal = 100%

SELECT NEW 0% VALUE
(IF NECESSARY)

PRESS

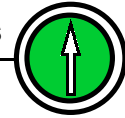

OR



Y

N

SELECT NEW 100%
VALUE (IF NECESSARY)

PRESS

SHIFT

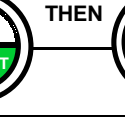

THEN



OR



Y

N



Aux I/P 4>0000<1
Invert 0000

CHANGE ALL VALUES FROM 1
TO 4 (OR 5 TO 8 IF THE CURSOR
IS ON THE BOTTOM LINE)

PRESS

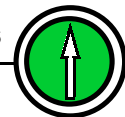

Y

N

SELECT AND CHANGE IN-
DIVIDUAL I/P'S

PRESS

SHIFT

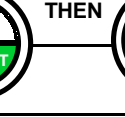

THEN

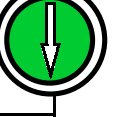

Y

N

CONTINUED

CONTINUED

Baud Rate = 1200
Add=001Mode=pos

A 3/5

RE-PROGRAMMING (CONTINUED)

Aux I/P 4>0000<1
Invert 0000



Torque Dev=00%
& timeout =000s

SELECT NEW TORQUE DEVIATION
SETTING (IF NECESSARY)



N

SELECT NEW TIMEOUT
SETTING (IF NECESSARY)



N



Torque filter
factor = 000

SELECT NEW FILTER
FACTOR (IF NECESSARY)



N



Press ↑ & ↓ to
program values



PLEASE WAIT
PROGRAMMING

Press ↑ & ↓ to
program values

SWITCH PAKTESTER OFF & ON &
CHECK THAT PARAMETERS HAVE
BEEN CORRECTLY PROGRAMMED

CONTINUED

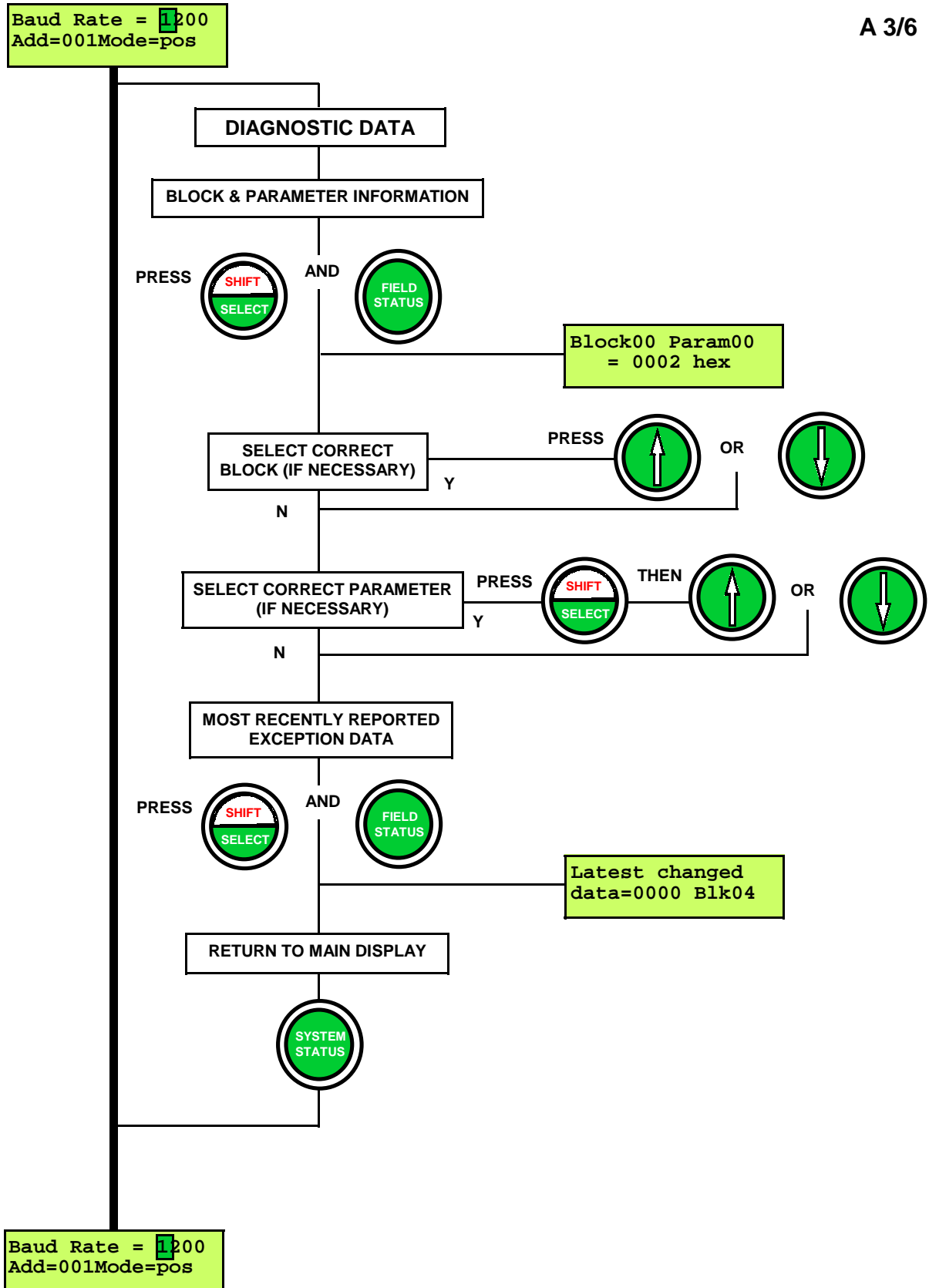

A 4/1 PAKTESTER OPTIONS – PAKSCAN 2 (GPFCU IN ACTUATOR MODE)

This procedure assumes that the GPFCU has been set to "Actuator Mode".
 To re-programme for "General Purpose Mode" see page A4/3

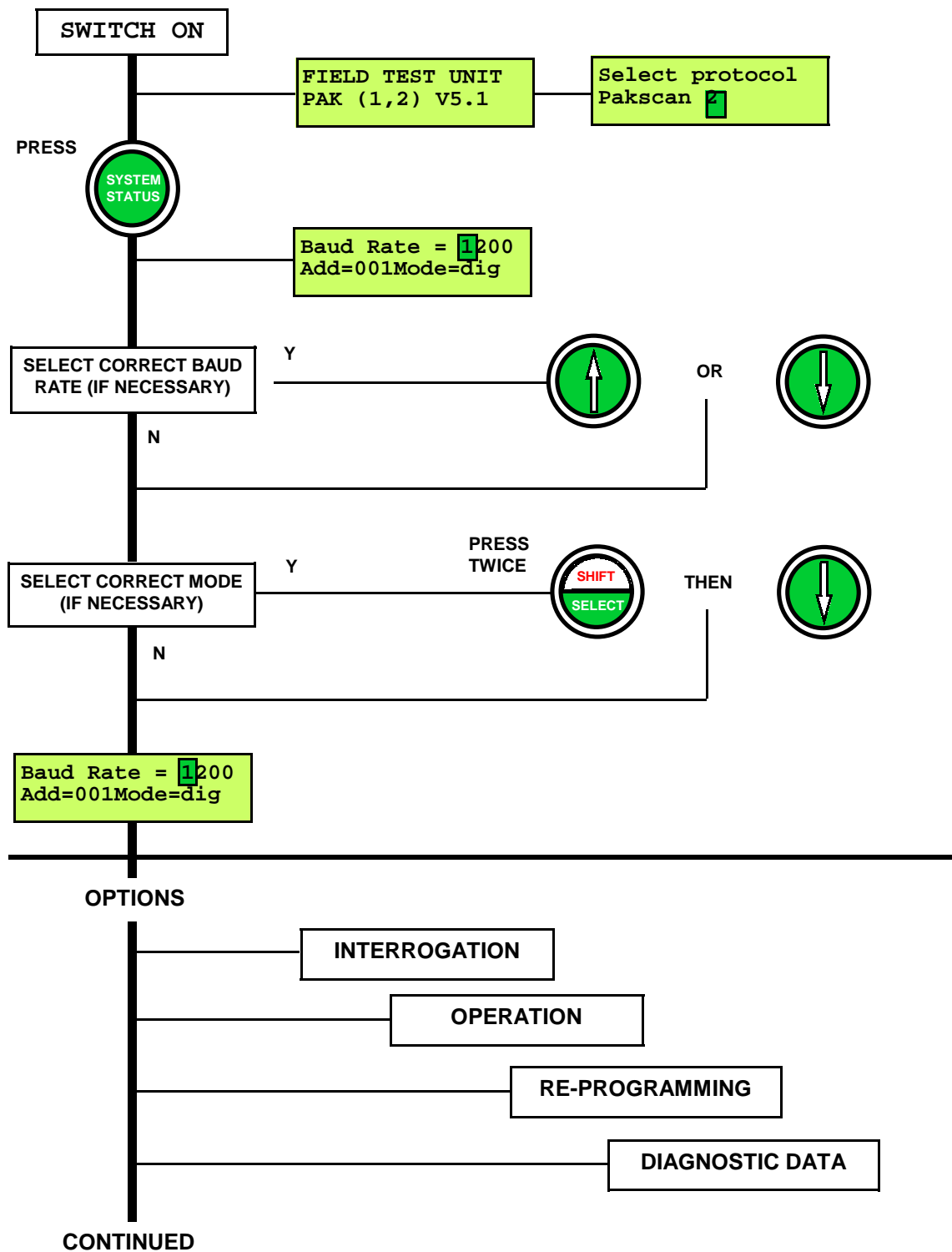

Baud Rate = 1200
Add=001Mode=dig

A 4/2

INTERROGATION

ALARM DISPLAY

PRESS



RL S M L
FIELD ALARMS A

TO ACCEPT ALARM

PRESS



FIELD STATUS

PRESS



DIGITAL (TYPE 1)

OA=0 OT=0 I1=0
CA=1 CT=0 I4=0

POSITIONAL (TYPE 3)

OA=0 OT=0 DVddd
CA=1 CT=0 MVmmm

Position	Display	Meaning
1	R	Relay (monitor)
2	L	Local stop
3	T	Thermostat
4	C	Control not available
5		(reserved)
6	S	Start / stop fail
7	J	Jammed valve
8	O	Obstructed valve
9	E	End of travel / stop fail
10	M	Manual operation
11		(reserved)
12	F	Memory fault
13	W	Watchdog
14	P	Power on reset
15		(reserved)
16	L (flashing)	Loopback on

Code	Description
OA	Open Limit Switch
CA	Closed Limit Switch
OT	Open Torque Limit Switch – Pak 1 only
CT	Close Torque Limit Switch – Pak 1 only
I1	Motor Stopped (Between limits)
I4	Motor Running
DV	Desired Value
MV	Measured Value

OPERATION

OPEN



STOP



CLOSE



ESD



CONTINUED

Baud Rate = 1200
Add=001Mode=dig

A 4/3

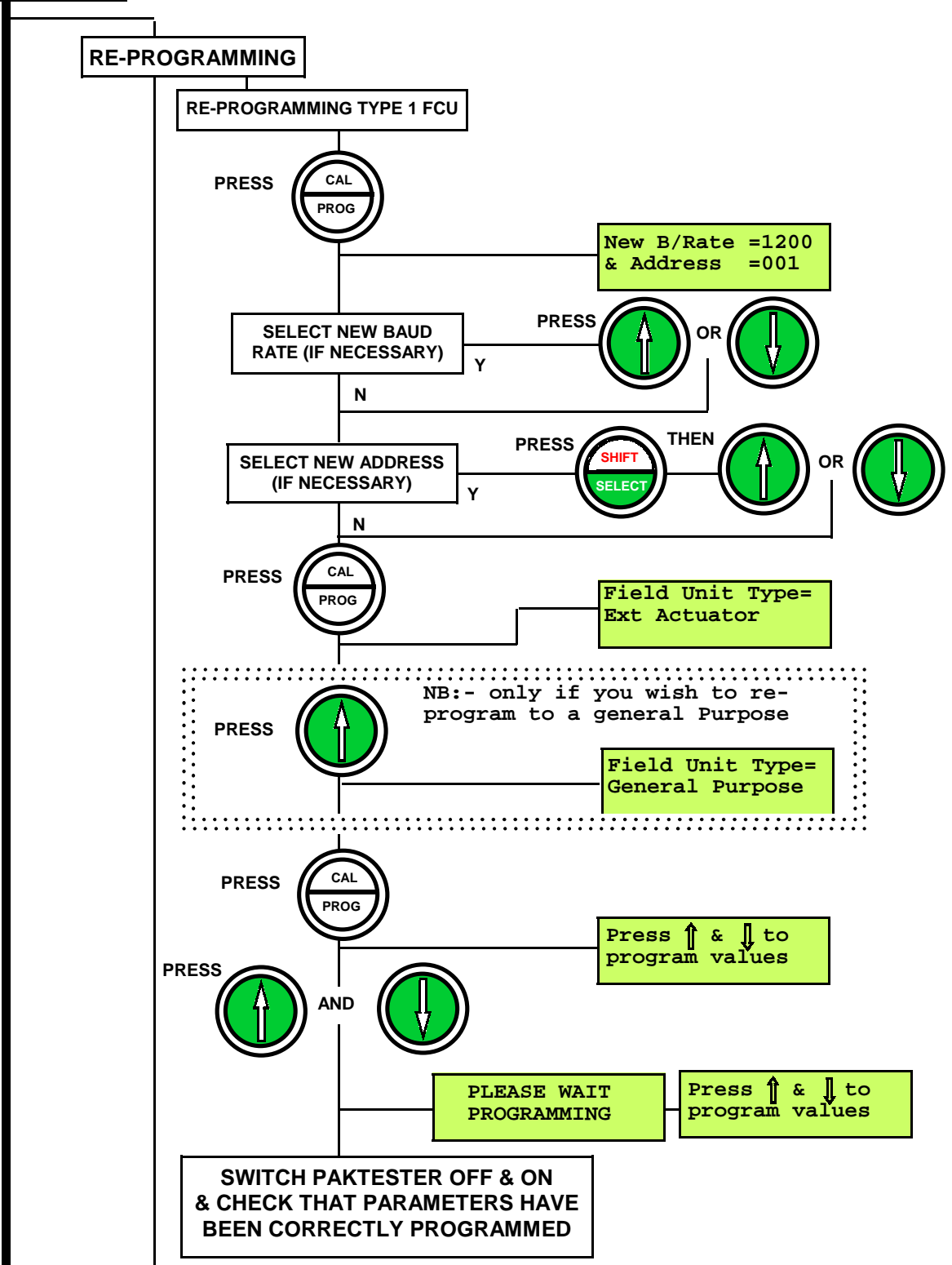

CONTINUED

Baud Rate = 1200
Add=001Mode=pos

RE-PROGRAMMING TYPE 3 FCU



PRESS 

New B/Rate =1200
& Address =001

SELECT NEW BAUD RATE (IF NECESSARY)

PRESS  OR 

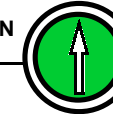
SELECT NEW ADDRESS (IF NECESSARY)

PRESS  THEN  OR 



PRESS 

New MITime =001s
& deadband =01%

SELECT NEW M.I.T. (IF NECESSARY)

PRESS  OR 

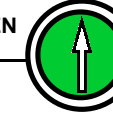
SELECT NEW DEADBAND (IF NECESSARY)

PRESS  THEN  OR 

CONTINUED

CONTINUED

Baud Rate = 1200
Add=001Mode=pos

RE-PROGRAMMING TYPE 3 FCU (CONTINUED)

New MITime =001s
& deadband =01%



Analog time=000s
& deadband =00%

SELECT NEW ANALOGUE
TIME (IF NECESSARY)

PRESS

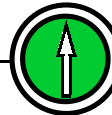

Y

N

SELECT NEW DEADBAND
(IF NECESSARY)

Y

PRESS

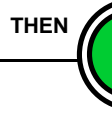

N



Field Unit Type=
Ext Actuator



NB:- only if you wish to re-program to a general Purpose

Field Unit Type=
General Purpose



Press ↑ & ↓ to
program values

PRES

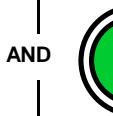

PLEASE WAIT
PROGRAMMING

Press ↑ & ↓ to
program values

SWITCH PAKTESTER OFF & ON
& CHECK THAT PARAMETERS HAVE
BEEN CORRECTLY PROGRAMMED

CONTINUED

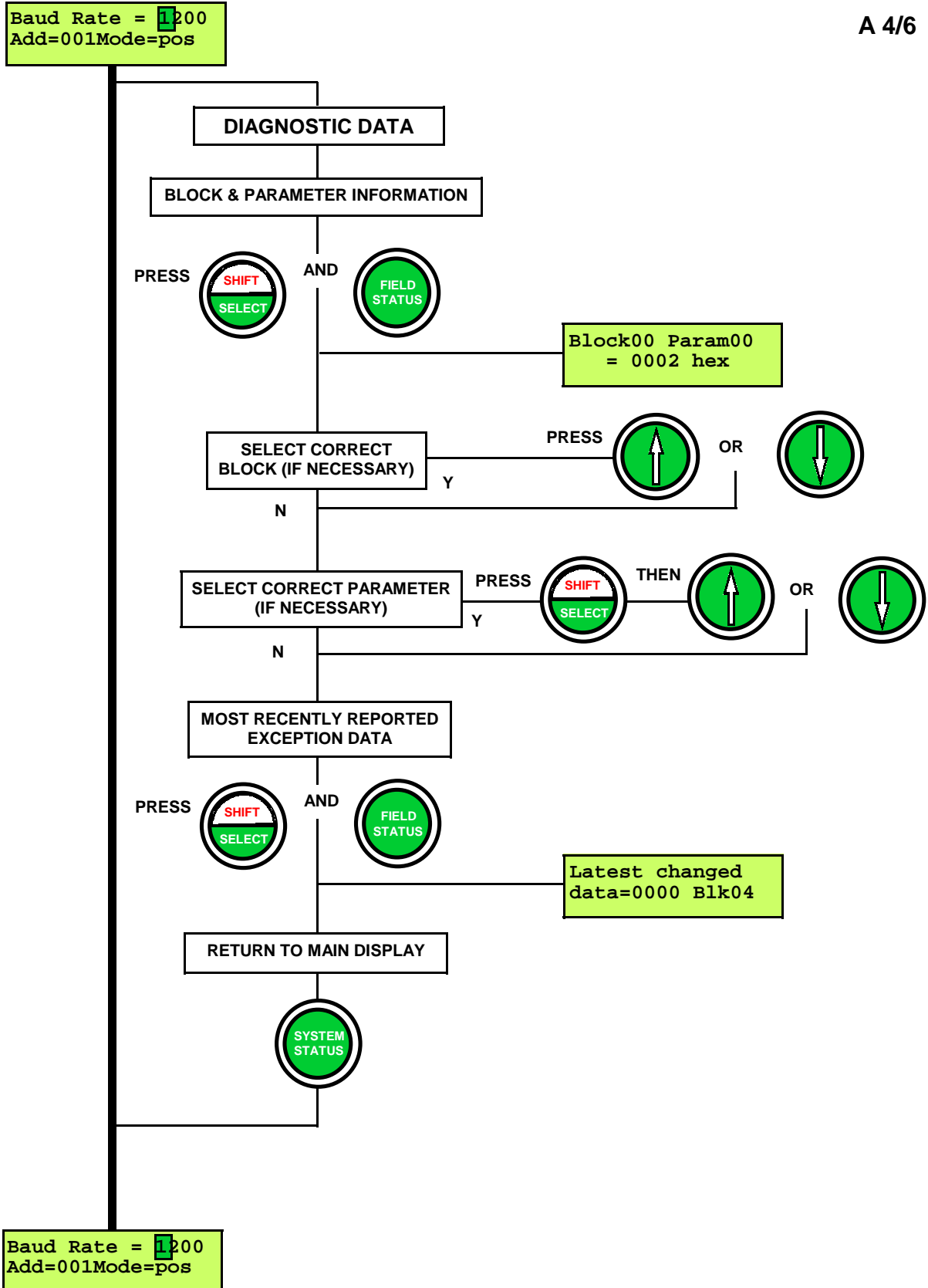

A 5/1 PAKTESTER OPTIONS – PAKSCAN 2 (GPFCU IN G.P. MODE)

This procedure assumes that the GPFCU has been set to "General Purpose Mode".
To re-programme for "Actuator Mode" see page A 5/3

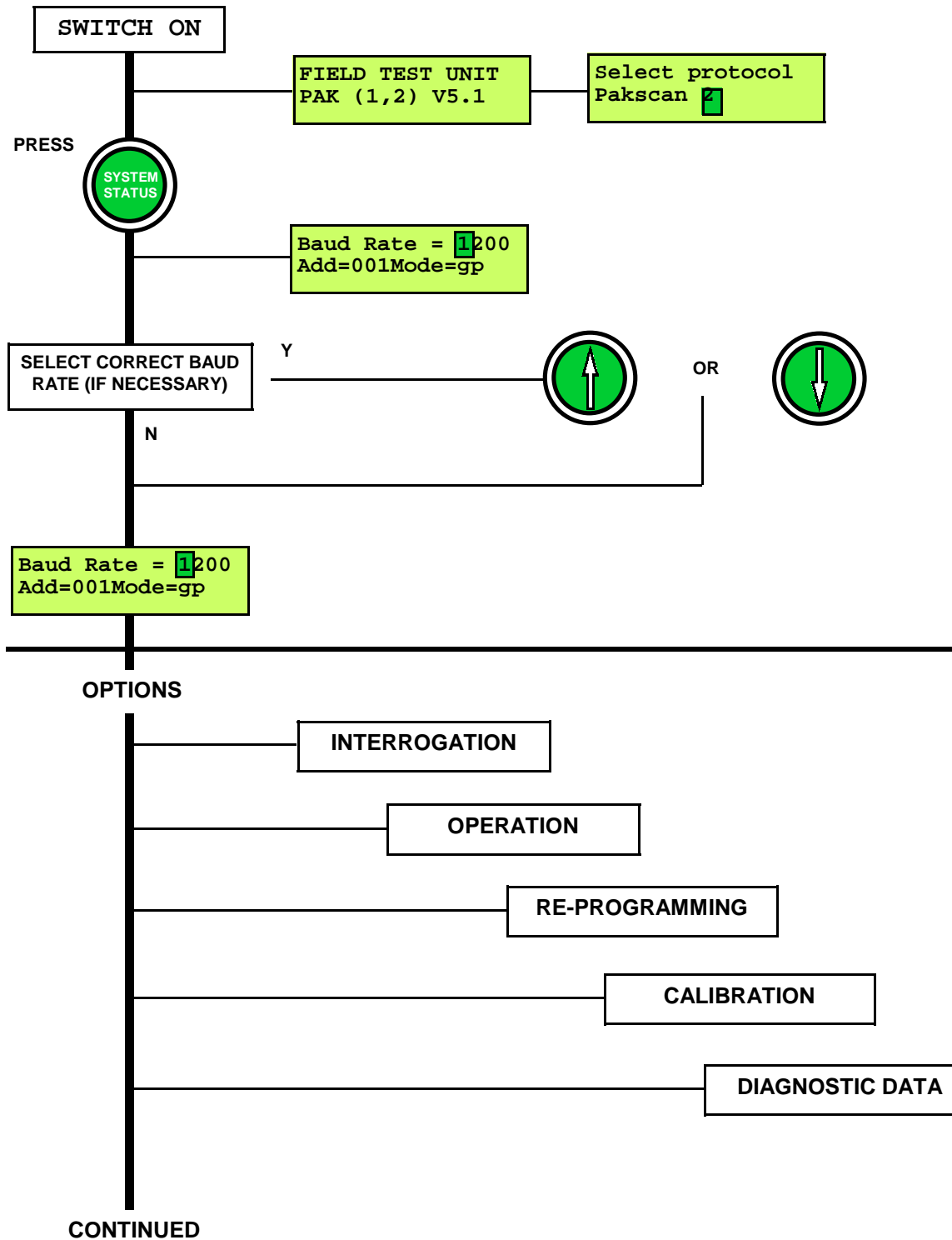

Baud Rate = 1200
Add=001Mode=gp

A 5/2

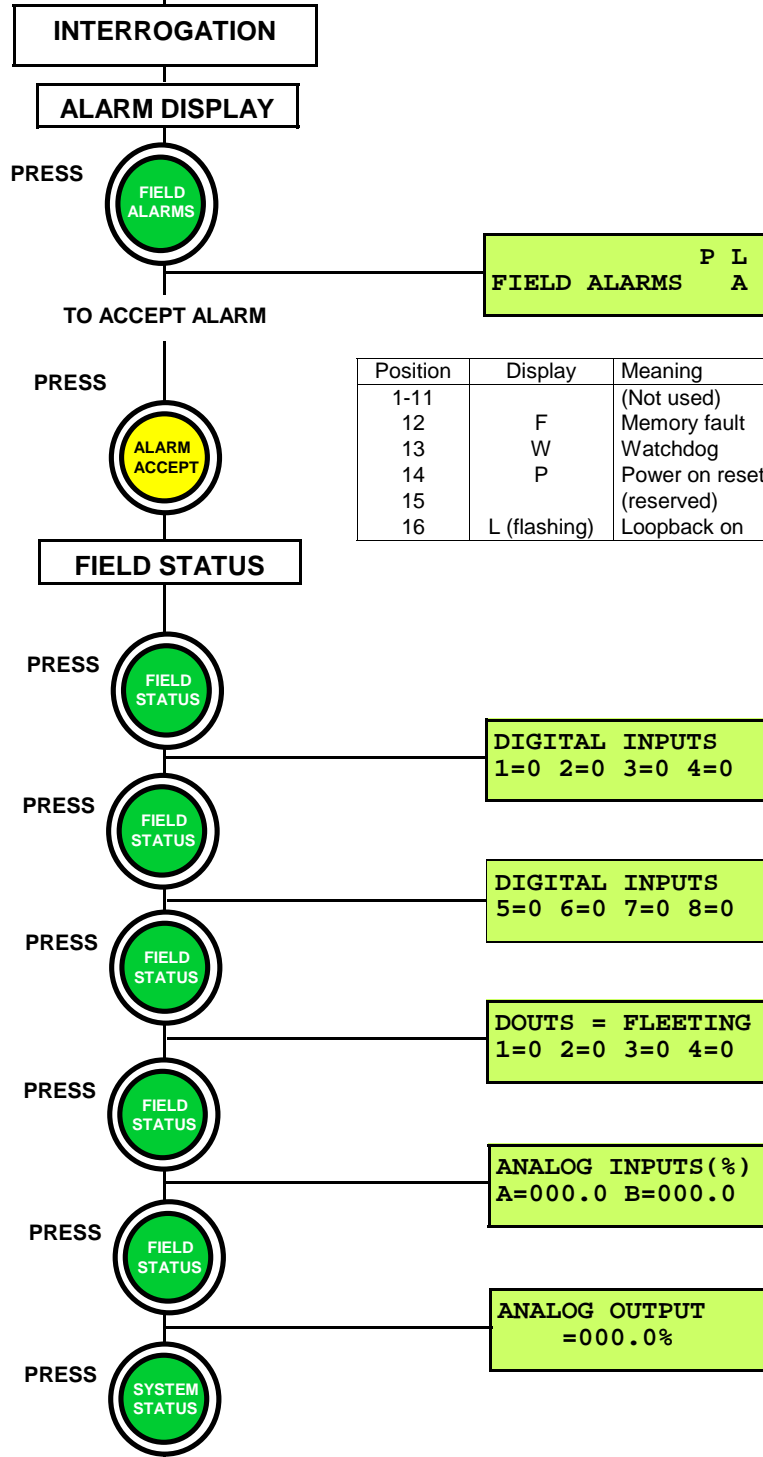

Position	Display	Meaning
1-11		(Not used)
12	F	Memory fault
13	W	Watchdog
14	P	Power on reset
15		(reserved)
16	L (flashing)	Loopback on

CONTINUED

Baud Rate = 1200
Add=001Mode=gp

A 5/3

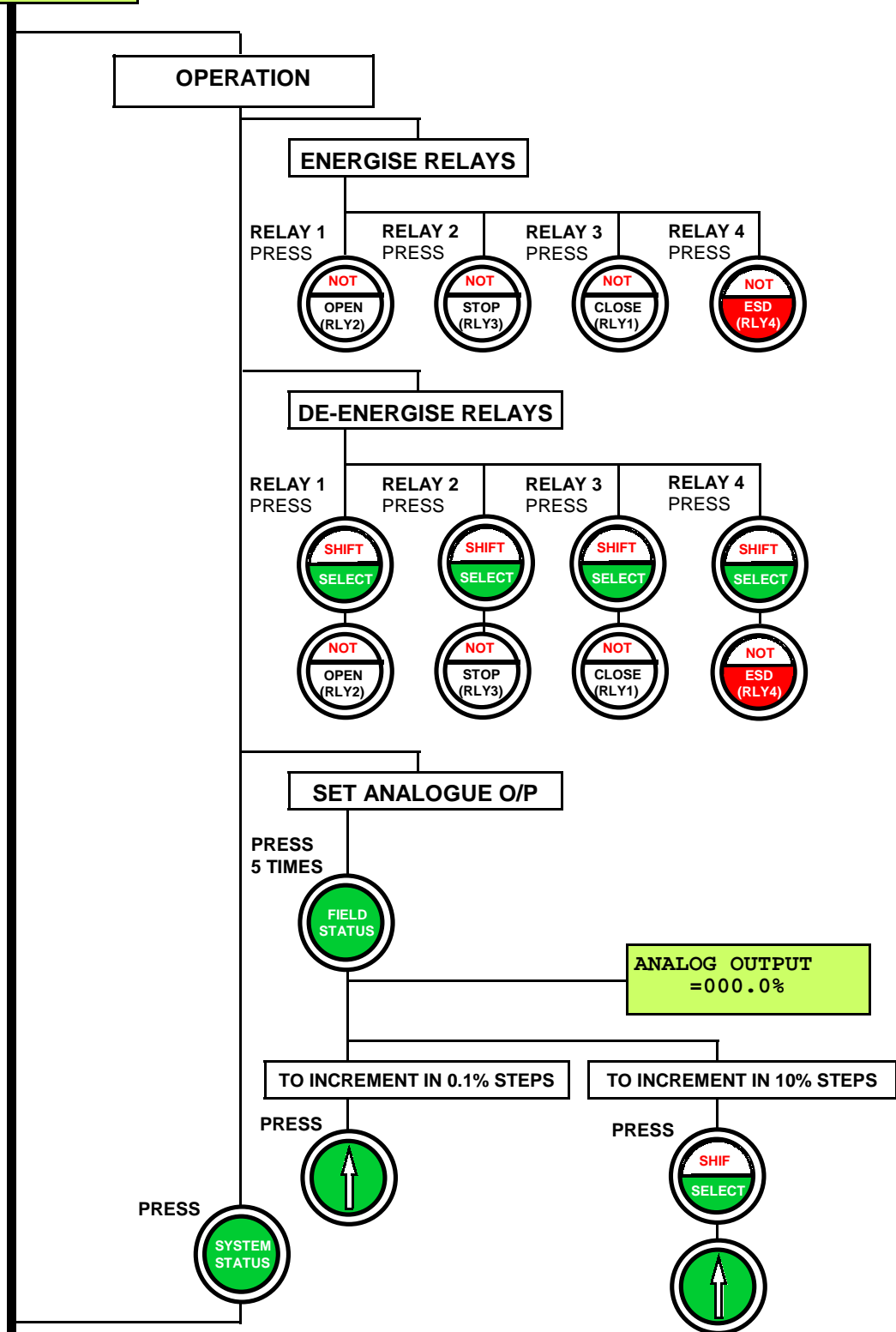

CONTINUED

Baud Rate = 1200
Add=001Mode=gp

A 5/4

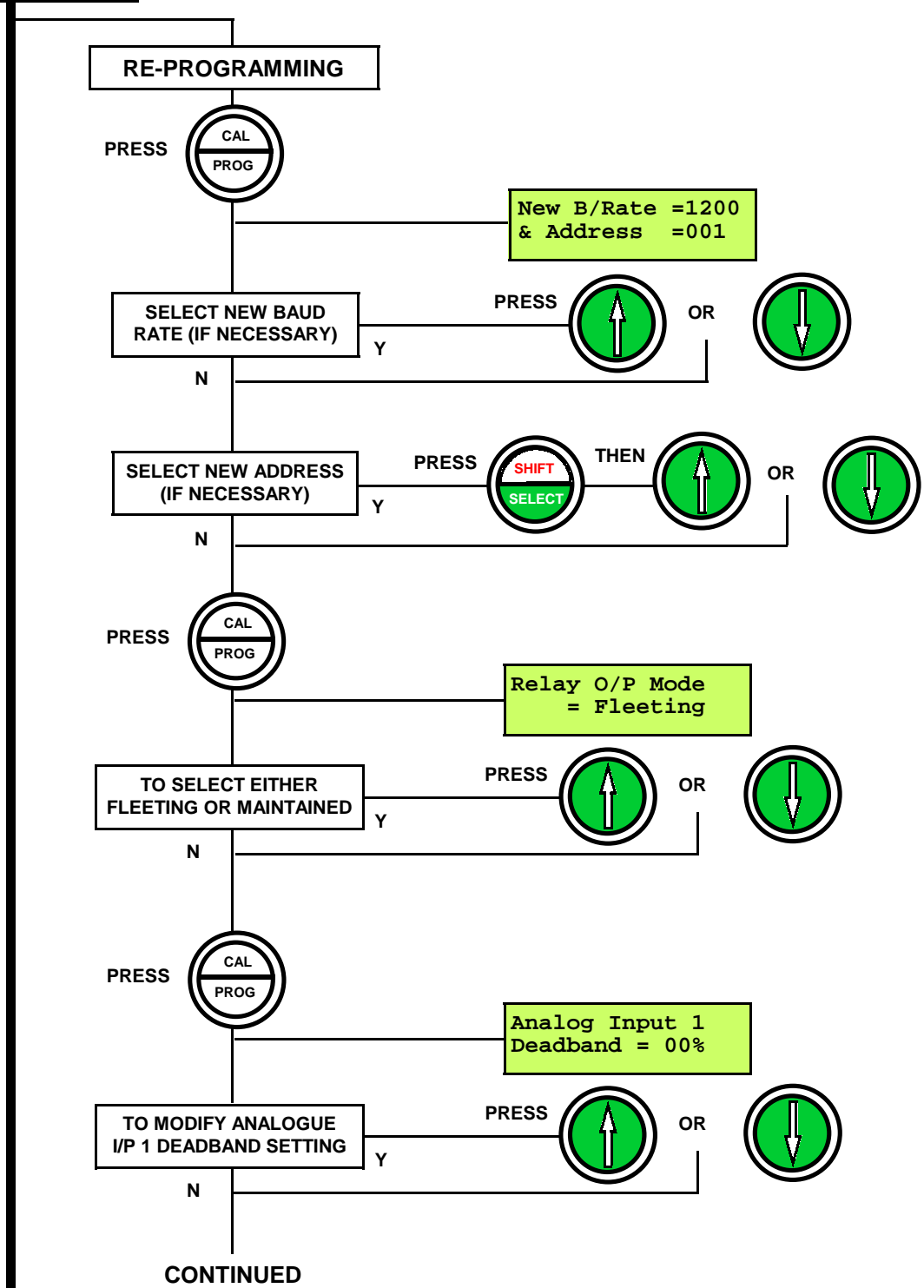

CONTINUED

Baud Rate = 1200
Add=001Mode=gp

RE-PROGRAMMING (CONTINUED)

Analog Input 1
Deadband = 00%



Analog Input 2
Deadband = 00%

TO MODIFY ANALOGUE
I/P 2 DEADBAND SETTING



Analog Report
Timeout = 000s

TO MODIFY ANALOGUE
REPORT SETTING

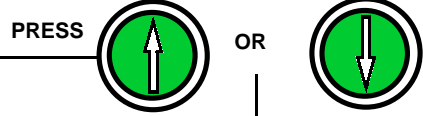

Dig I/P Sense
(8)00011100(1)

TO SELECT DIGIT



TO SELECT 1 OR 0

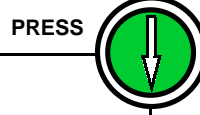

TO CHANGE ALL DIGITS TO 1 OR 0



CONTINUED

CONTINUED

Baud Rate = 1200
Add=001Mode=pos

RE-PROGRAMMING (CONTINUED)

Dig I/P Sense
(8)00011100(1)



Field Unit Type=
General Purpose

PRESS

NB:- only if you wish to re-program to a general Purpose

Field Unit Type=
Ext Actuator



Press ↑ & ↓ to
program values

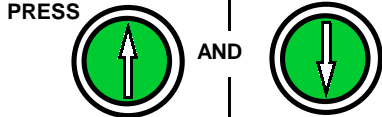

PLEASE WAIT
PROGRAMMING

Press ↑ & ↓ to
program values

SWITCH PAKTESTER OFF & ON
& CHECK THAT PARAMETERS HAVE
BEEN CORRECTLY PROGRAMMED

CONTINUED

Baud Rate = 1200
Add=001Mode=gp

A 5/7

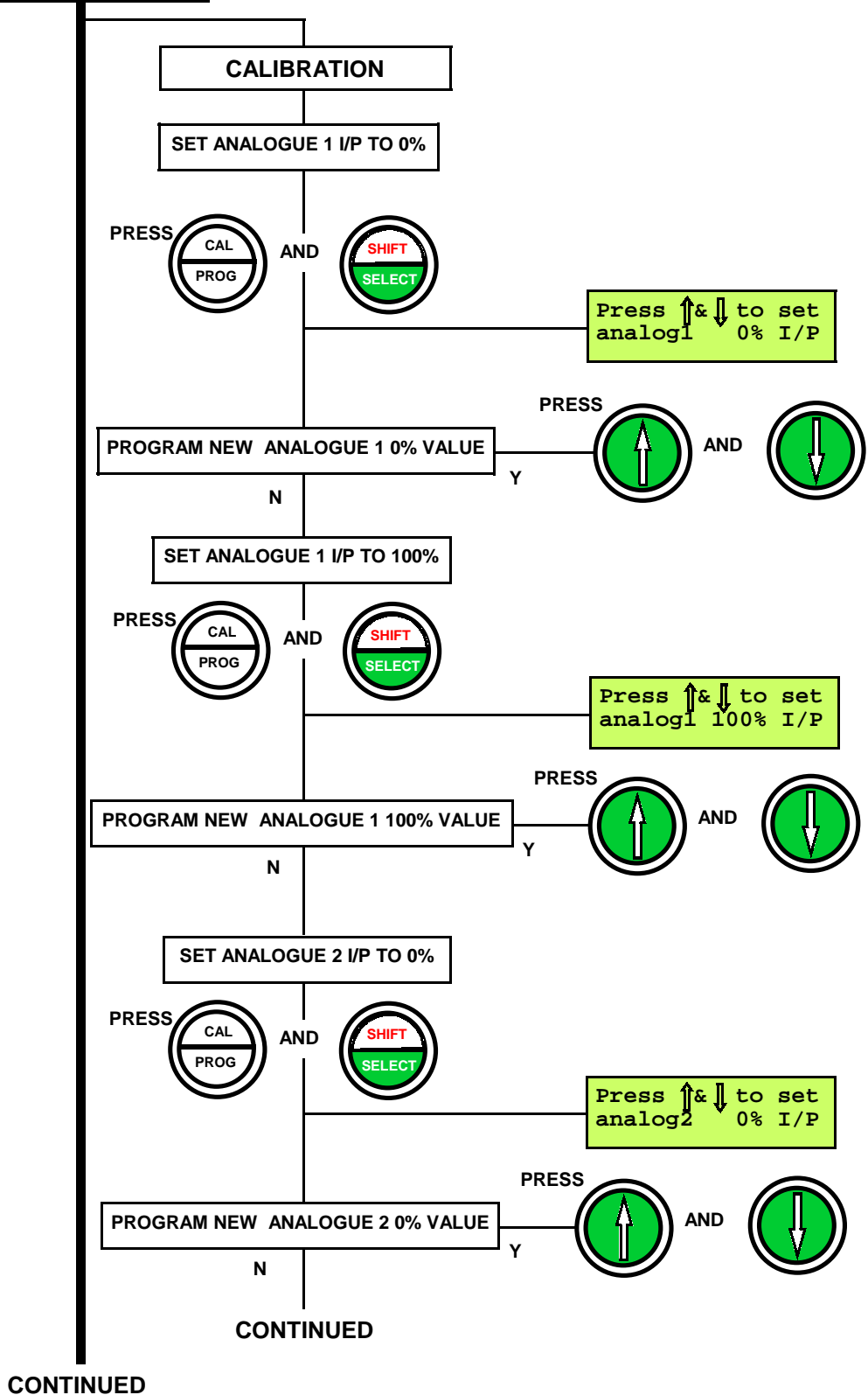

Baud Rate = 1200
Add=001Mode=gp

A 5/8

CALIBRATION (CONTINUED)

Press ↑ & ↓ to set
analog2 0% I/P

SET ANALOGUE 2 I/P TO 100%

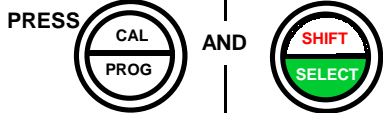

Press ↑ & ↓ to set
analog2 100% I/P

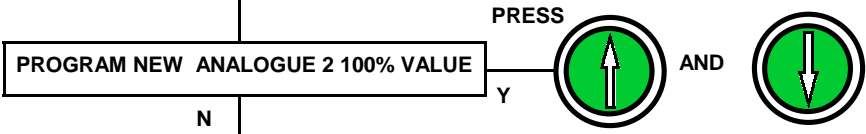

SET ANALOGUE O/P TO 0%
(SEE SECTION 5/3)

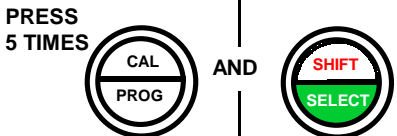

ANALOG OUTPUT
=000.0%

Analog o/p cal'n
0% setting=00

PUT VOLTMETER ACROSS O/P TERMINALS AND ADJUST
"SETTING" UNTIL REQUIRED ZERO VALUE IS OBTAINED

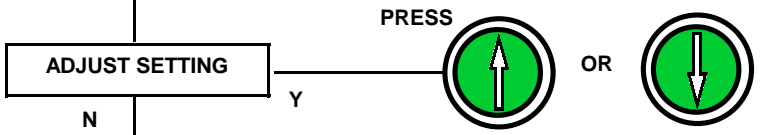

CONTINUED

CONTINUED

Baud Rate = 1200
Add=001Mode=gp

A 5/9

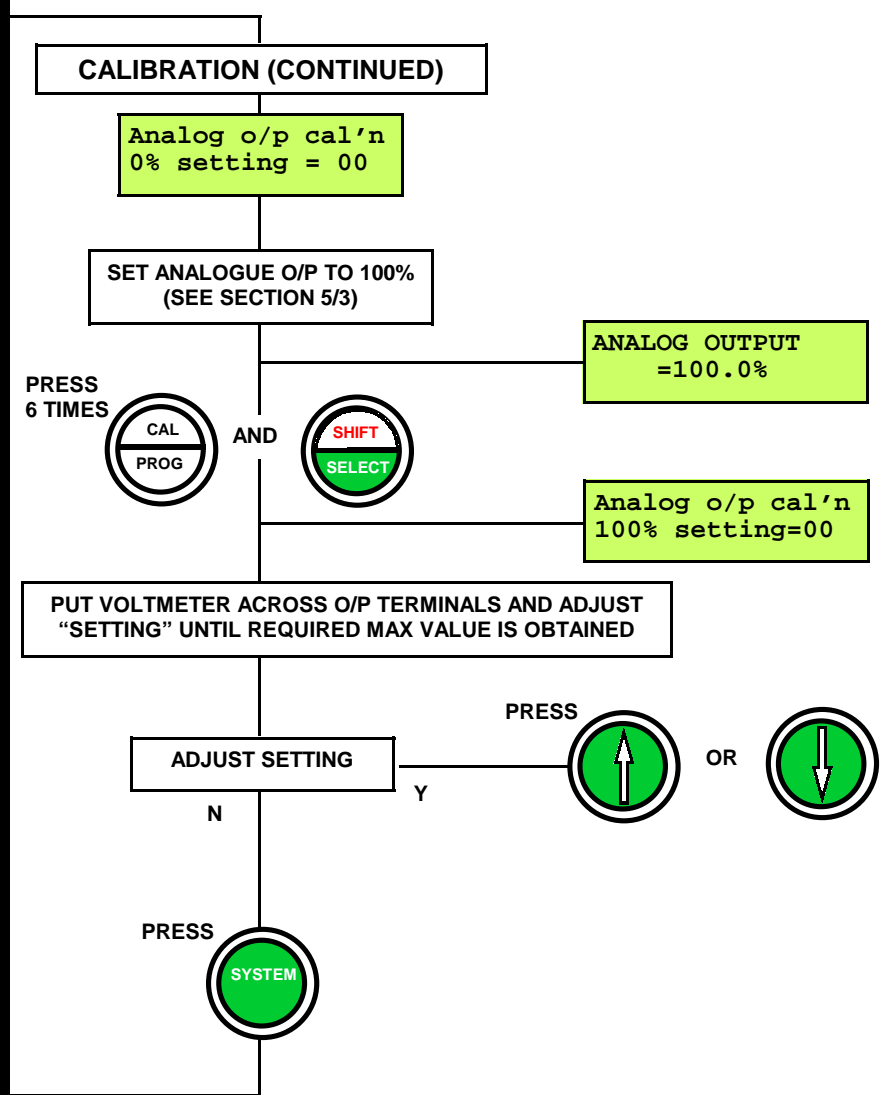

CONTINUED

A 6/1 PAKTESTER OPTIONS – PAKSCAN 2 (IQ ANALOGUE CARD)

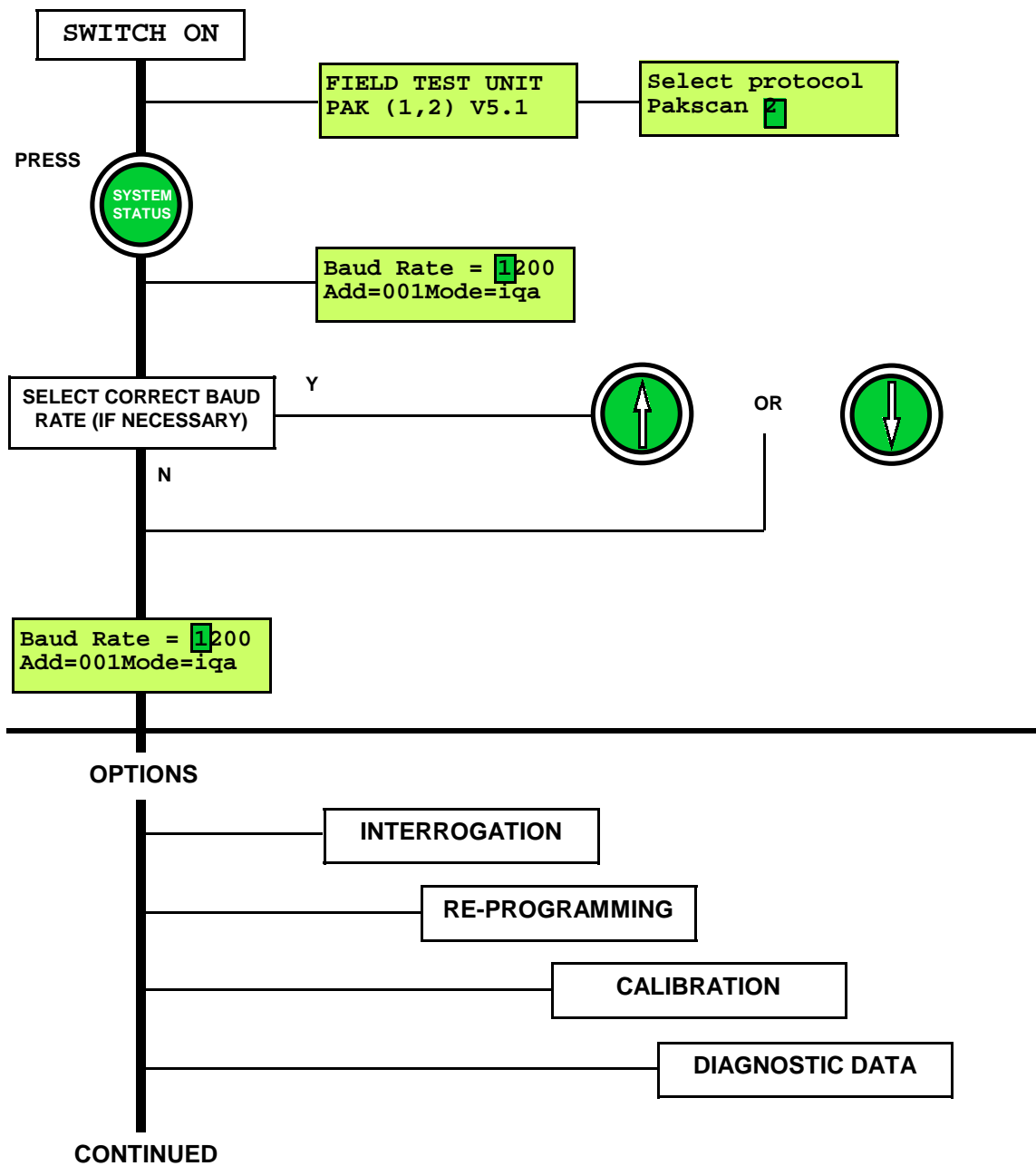

Baud Rate = 1200
Add=001Mode=iqa

A 6/2

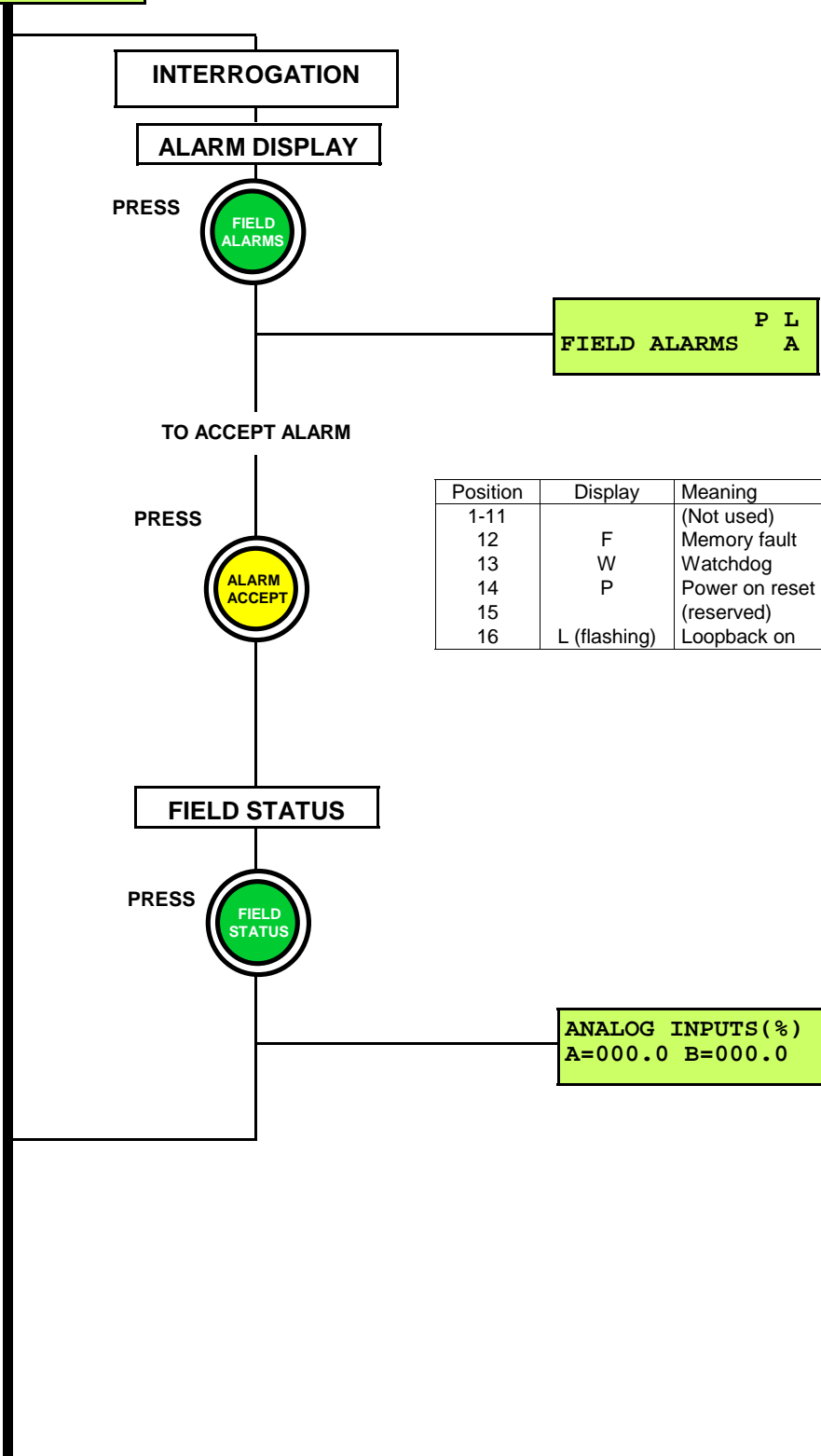

Position	Display	Meaning
1-11		(Not used)
12	F	Memory fault
13	W	Watchdog
14	P	Power on reset
15		(reserved)
16	L (flashing)	Loopback on

CONTINUED

Baud Rate = 1200
Add=001Mode=gp

A 6/3

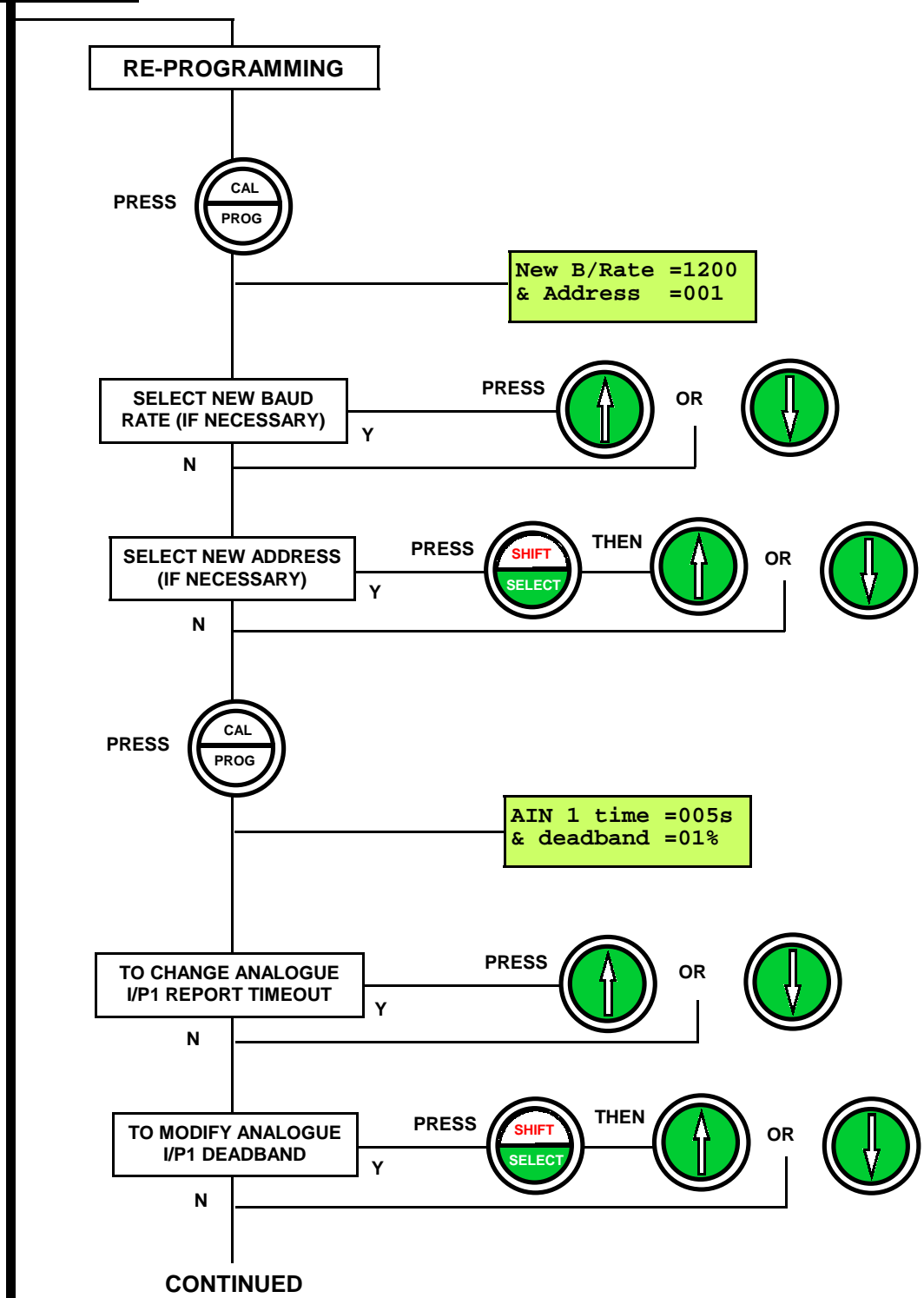

CONTINUED

Baud Rate = 1200
Add=001Mode=gp

RE-PROGRAMMING (CONTINUED)

AIN 1 time =005s
& deadband =01%



AIN 2 time =005s
& deadband =01%

TO CHANGE ANALOGUE
I/P2 REPORT TIMEOUT



TO MODIFY ANALOGUE
I/P2 DEADBAND

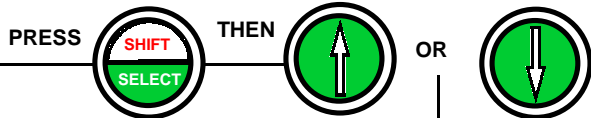

AIN 1 Mode =mA
AIN 2 Mode =mA

TO CHANGE ANALOGUE I/P1
SOURCE (CURRENT OR VOLTS)



TO CHANGE ANALOGUE I/P1
SOURCE (CURRENT OR VOLTS)

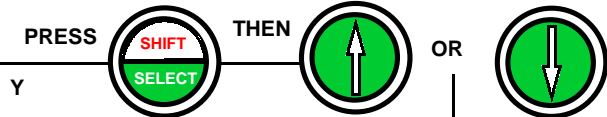

CONTINUED

CONTINUED

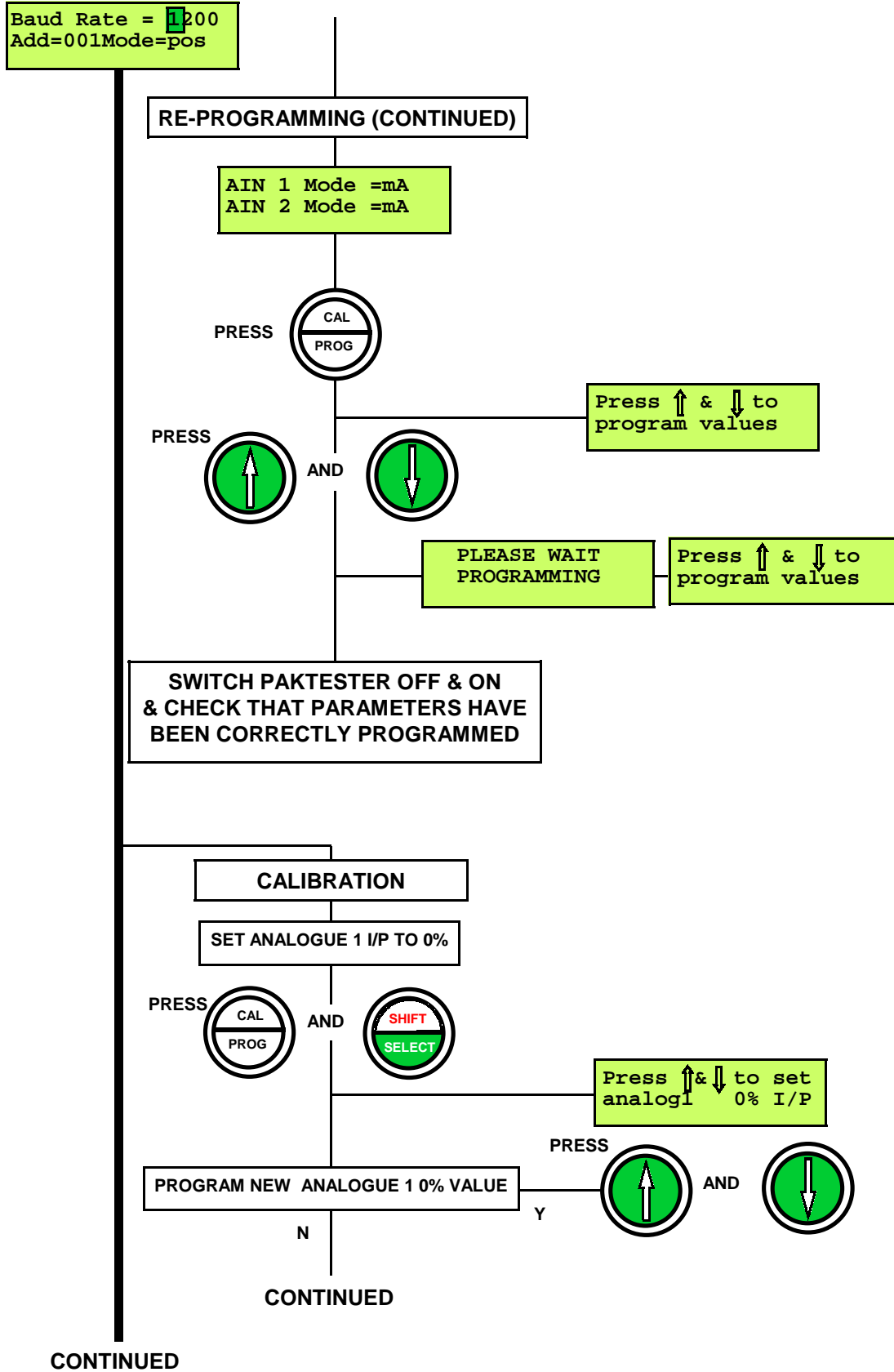

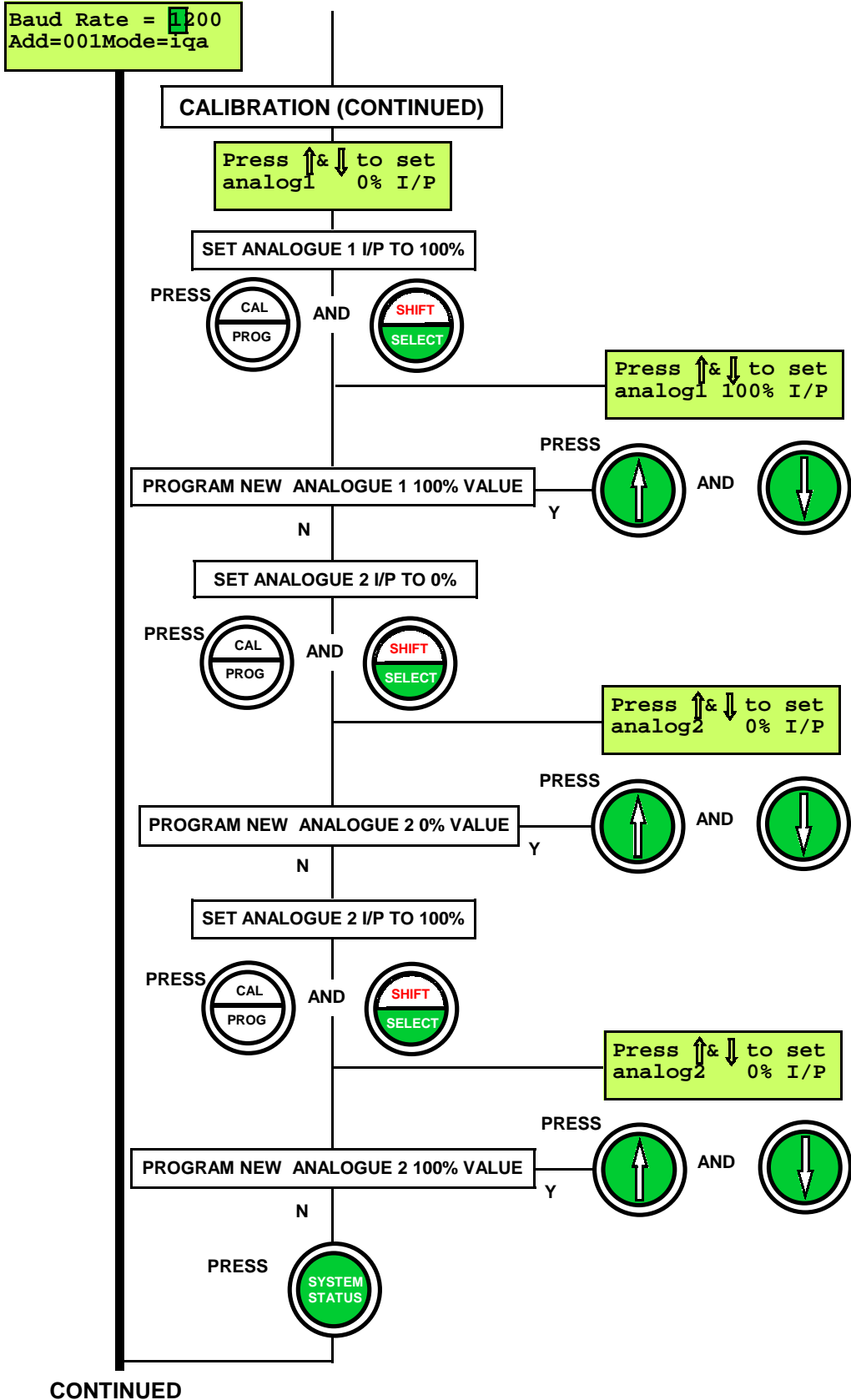

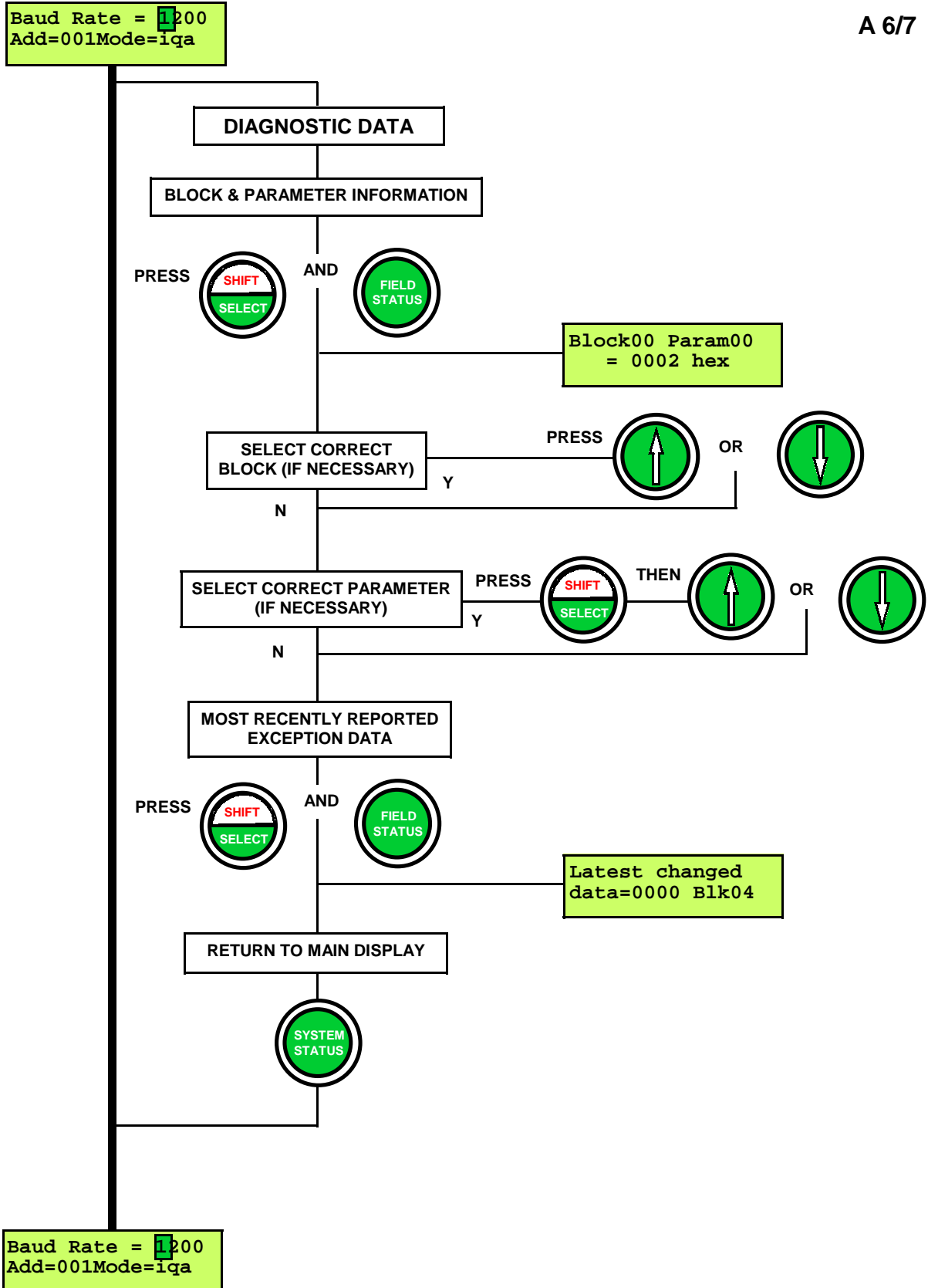

A 7/1 PAKTESTER OPTIONS – PAKSCAN 2 (FLOWPAK ACTUATOR FCU'S)

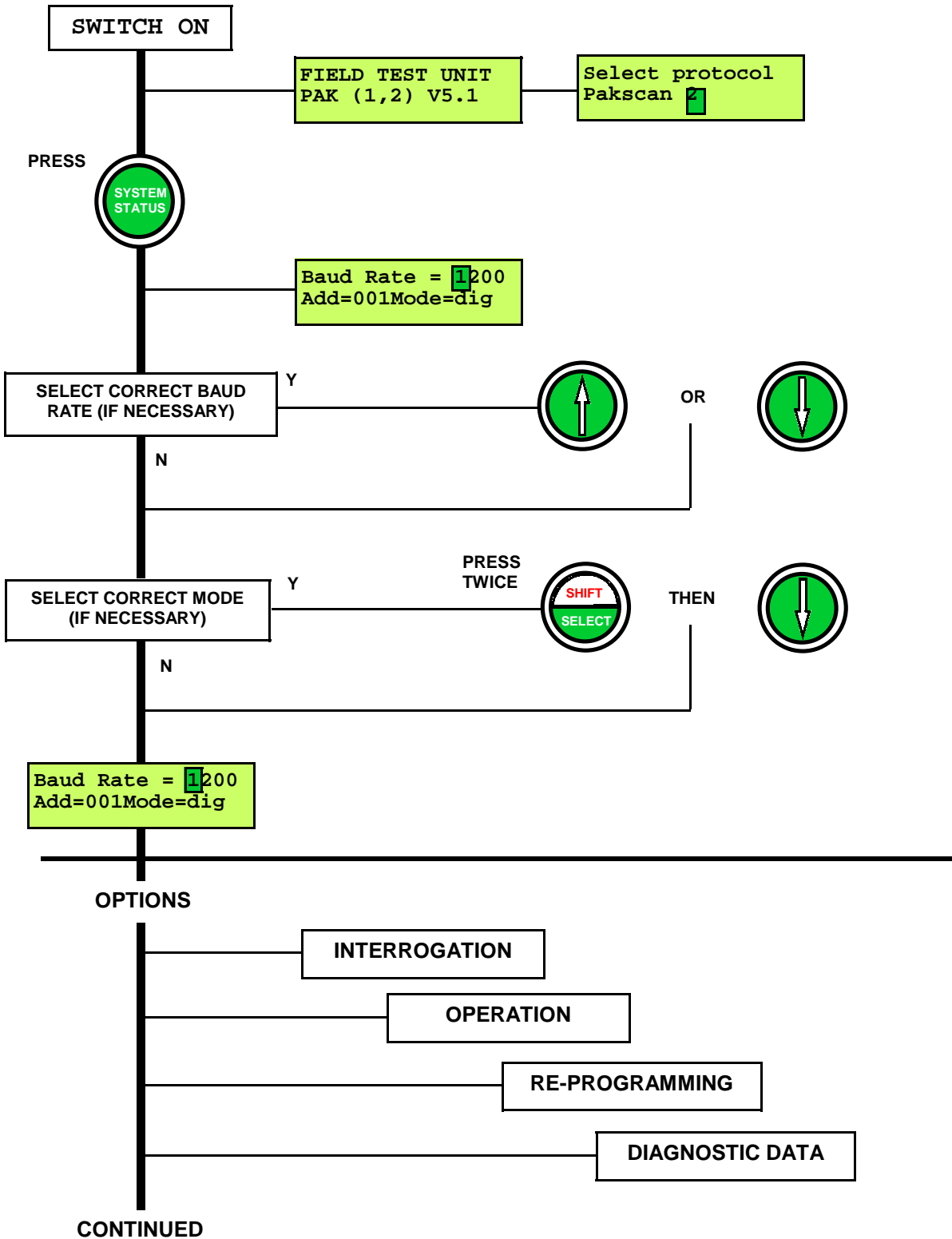

Baud Rate = 1200
Add=001Mode=dig

INTERROGATION

ALARM DISPLAY

PRESS



RL S M L
FIELD ALARMS A

TO ACCEPT ALARM

PRESS



Position	Display	Meaning
1	R	Relay (monitor)
2	L	Local stop
3	T	Low pressure
4	C	Control not available (reserved)
5		(reserved)
6	S	Start / stop fail
7	J	Jammed valve
8	O	Obstructed valve
9	E	End of travel / stop fail
10	M	Manual operation (reserved)
11		(reserved)
12	F	Memory fault
13	W	Watchdog
14	P	Power on reset (reserved)
15		(reserved)
16	L (flashing)	Loopback on

FIELD STATUS

PRESS



DIGITAL (TYPE 1)

OA=0 OT=0 I1=0
CA=1 CT=0 I4=0

POSITIONAL (TYPE 3)

OA=0 OT=0 DVddd
CA=1 CT=0 MVmmm

Code	Description
OA	Open Limit Switch
CA	Closed Limit Switch
OT	Open Torque Limit Switch - Pak 1 only
CT	Close Torque Limit Switch - Pak 1 only
I1	Motor Stopped (Between limits)
I4	Motor Running
DV	Desired Value
MV	Measured Value

OPERATION

OPEN



STOP



CLOSE



ESD



CONTINUED

Baud Rate = 1200
Add=001Mode=dig

A 7/3

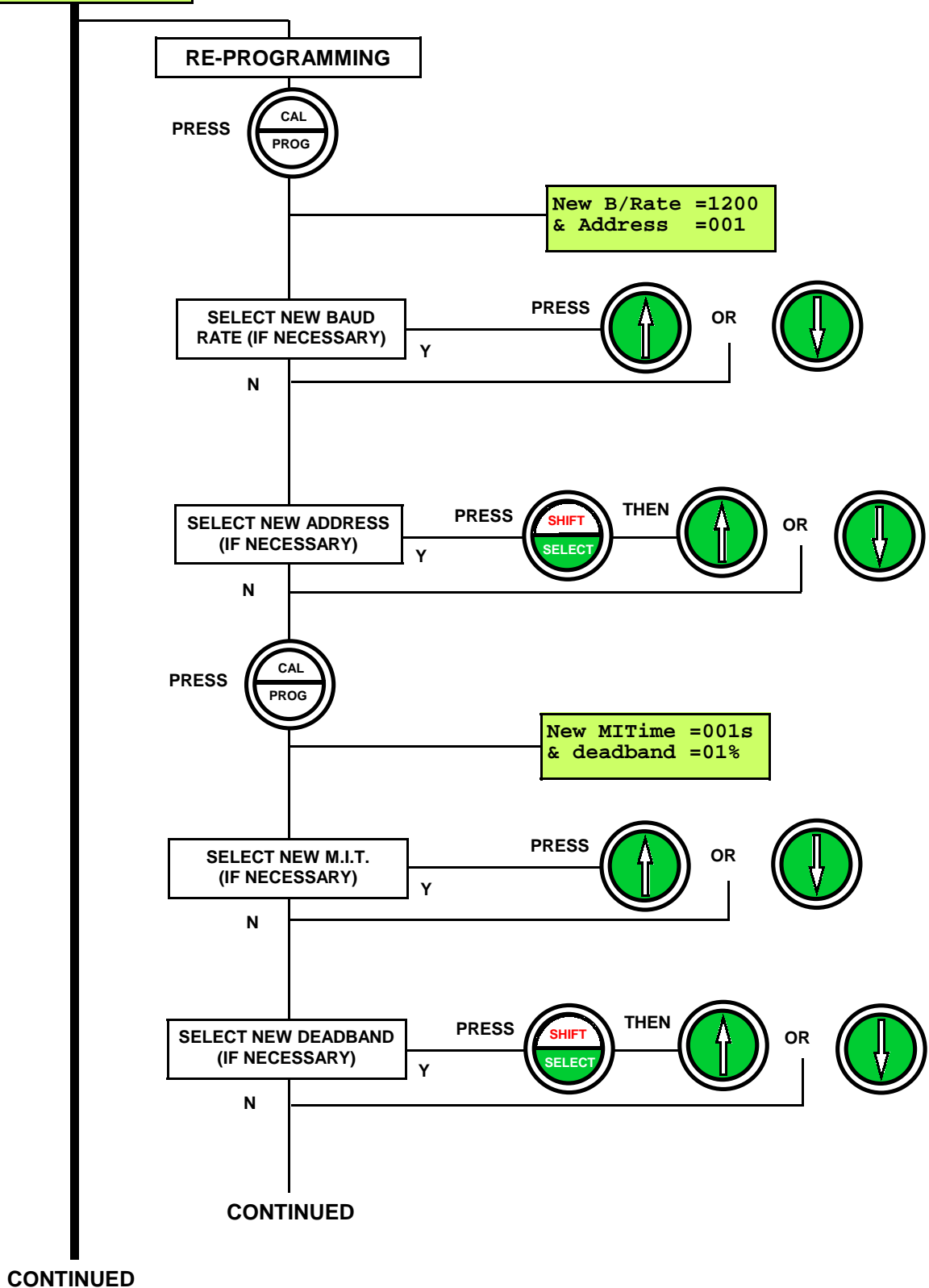

Baud Rate = 1200
Add=001Mode=dig

A 7/4

RE-PROGRAMMING (CONTINUED)

New MITime =001s
& deadband =01%



Analog time=000s
& deadband =00%

SELECT NEW ANALOG
TIME (IF NECESSARY)

PRESS

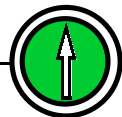

OR



Y

N

SELECT NEW DEADBAND
(IF NECESSARY)

PRESS



THEN



OR



Y

N



Actuator Speed =
FAST

ADJUST SPEED TO FAST, NORMAL
OR SLOW (IF NECESSARY)

PRESS

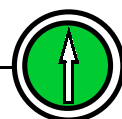

OR



Y

N

CONTINUED

CONTINUED

Baud Rate = 1200
Add=001Mode=dig

A 7/5

RE-PROGRAMMING (CONTINUED)

Actuator Speed =
FAST



Manual release
pulse = 50

SELECT NEW RELEASE
PULSE TIME (IF NECESSARY)



Press & to
program values

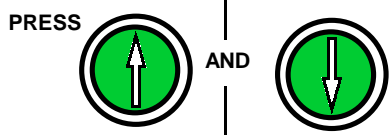

PLEASE WAIT
PROGRAMMING & to
program values

SWITCH PAKTESTER OFF & ON &
CHECK THAT PARAMETERS HAVE
BEEN CORRECTLY PROGRAMMED

CONTINUED

Baud Rate = 1200
Add=001Mode=dig

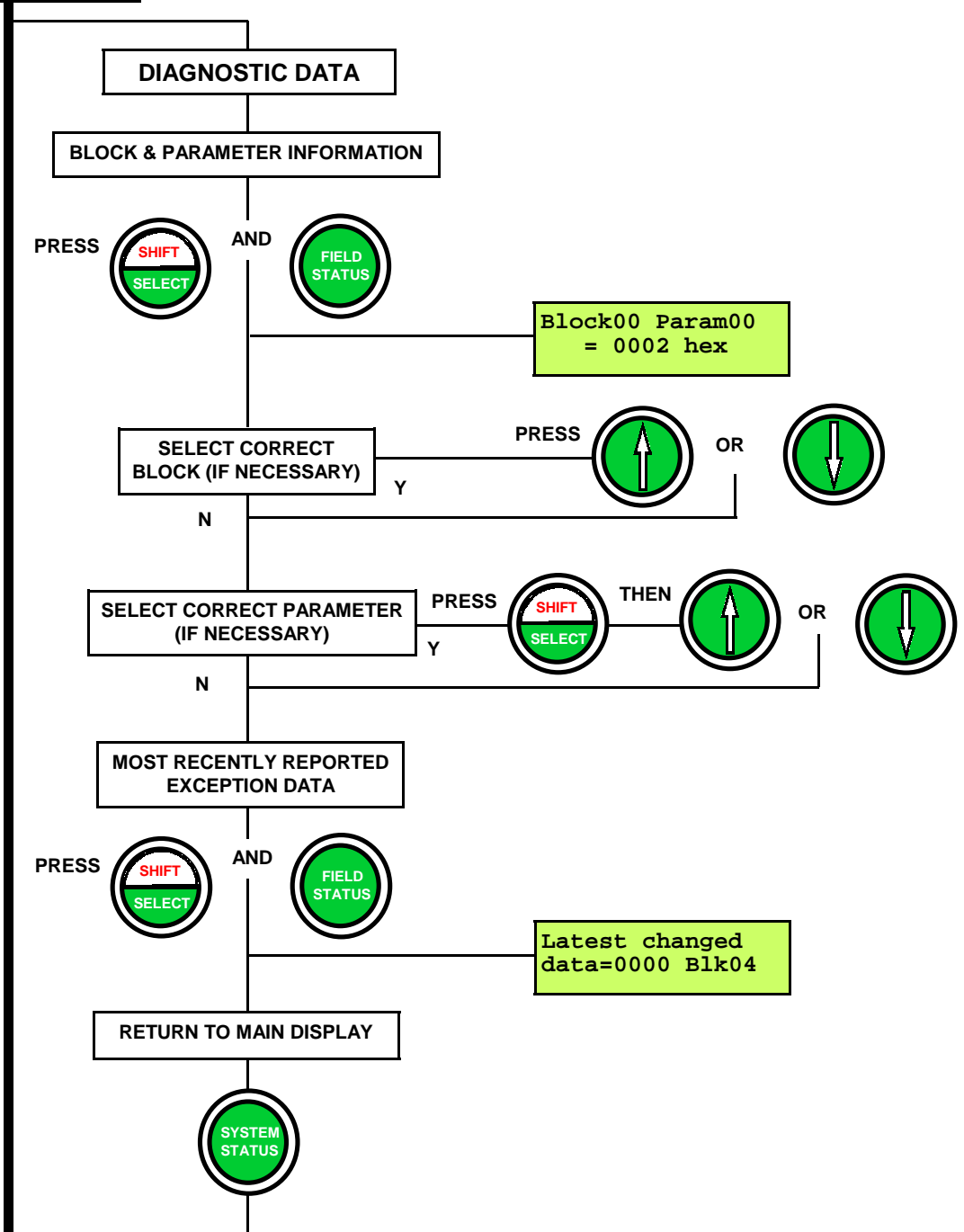

Baud Rate = 1200
Add=001Mode=dig

A8. Use of Field Test Unit with Non-Actuator Field Unit

The Paktester when in Pakscan I mode expects to communicate with a standard Rotork FCU being used with an actuator. If connected to an alternative FCU type then the display and commands need to be interpreted accordingly.

A8.1. Type 1A Field Units (Pakscan I)

A6.1.1.Digital Outputs

The four digital outputs correspond to the four relays on a standard field unit as follows:-

OUTPUT (1A)	OUTPUT (standard)	CON 3 PINOUT			PAKTESTER COMMAND
		COM	N/O	N/C	
RELAY 1	CLOSE	1	2	3	CLOSE
RELAY 2	OPEN	4	5	6	OPEN
RELAY 3	STOP	7	9	8	STOP
RELAY 4	ESD	10	12	11	ESD

Hence by pressing "CLOSE", "OPEN", "STOP", or "ESD" the relays 1,2,3 or 4 may be energised.

If fleeting relay operation has been selected then the relay will de-energise 350 mS later.

If maintained relay operation is selected then the operation will be as follows:-

"CLOSE" energises RELAY 1 and de-energises RELAYS 2, 3 and 4

"OPEN" energises RELAY 2 and de-energises RELAYS 1, 3 and 4

"STOP" energises RELAY 3 and de-energises RELAYS 1, 2 and 4

"ESD" energises RELAY 4 and has no effect upon the others

(E = Energise D = De-energise F = Fleeting Operation X = No effect)

Command	Fleeting Relay Operation				Maintained Relay Operation			
	1	2	3	4	1	2	3	4
CLOSE	F	X	X	X	E	D	D	D
OPEN	X	F	X	X	D	E	D	D
STOP	X	X	F	X	D	D	E	D
ESD	X	X	X	F	X	X	X	E

A8.1.2.Digital Inputs

Ten digital inputs are available on a type 1A Field Unit. These are transmitted to the FCU and interpreted by the Paktester as ordinary actuator status bits. The following table shows the relationship between the 1A digital inputs, the standard FCU digital inputs and how the data is displayed at the FCU.

1A Digital	Standard FCU Digital I/P	Con 2 Pin Nr	Paktester display for	
			Input Active	Input Inactive
Input 0	OTLS	1	OTLS = 1	OTLS = 0
Input 1	CTLS	2	CTLS = 1	CTLS = 0
Input 2	OAS	3	OAS = 1	OAS = 0
Input 3	CAS	4	CAS = 1	CAS = 0
Input 4	IAS1	5	IAS1 = 1	IAS1 = 0
Input 5	IAS4	6	IAS4 = 1	IAS4 = 0
Input 6	MR	7	OAS status flashing	OAS status steady
Input 7	CNA	8	CAS status flashing	CAS status steady
Input 8	MON	9	No indication	No indication
Input 9	LSTOP	11	No indication	No indication
Common		12		

All inputs are active high (+5V) or normally closed contacts, (i.e. open circuit input is active)

A8.1.3.Analogue Input

The analogue input may be monitored by selecting "MODE = ANG" on the Paktester SYSTEM STATUS display. The unit will now indicate a value between 0 and 255 on the FIELD STATUS display which corresponds to an input of between 0% and 100% of a 5V reference.

If current inputs are being used this corresponds to a nominal full scale input of 0 to 20.8mA.

A8.2. Use of Paktester with a Pump Control Unit (Pakscan I)

A8.2.1 Digital Outputs

The pump unit provides only fleeting outputs from the three relays "OPEN", "STOP", and "CLOSE" and a maintained output from the "ESD" relay which is cancelled by any of the former three relay commands.

OUTPUT (1A)	OUTPUT (standard)	CON 3 PINOUT			PAKTESTER COMMAND	Comments
		COM	N/O	N/C		
START	OPEN	4	5	6	OPEN	Fleeting
STOP	STOP	7	9	8	STOP	Fleeting
ESD	ESD	10	12	11	ESD	Maintained
-	CLOSE	1	2	3	CLOSE	Maintained

A8.2.2. Digital Inputs

Five digital inputs may be used on a pump unit. These correspond to inputs from an actuator as follows:-

Pump Input	Actuator Input	Con 2 Pin Nr	Paktester display for	
			Input Active	Input Inactive
Running	OAS	3	OAS = 1 (flashing)	OAS = 0 (steady)
Stopped	IAS1	5	IAS1 = 1	IAS1 = 0
Monitor 1	IAS4	6	IAS4 = 1	IAS4 = 0
Monitor 2	OTLS	1	OTLS = 1	OTLS = 0
Monitor 3	CTLS	2	CTLS = 1	CTLS = 0

All inputs are active high (+5V) or normally closed contacts, (i.e. open circuit input is active).

A8.2.3. Analogue Input

The Analogue input may be monitored by selecting "MODE = ANG" on the Paktester SYSTEM STATUS display. The unit will now indicate a value between 0 and 255 on the FIELD STATUS display which corresponds to an input of between 0% and 100% of a 5V reference.

If current inputs are being used this corresponds to a nominal full scale input of 0 to 20.8mA.

A9 Programming example

This example is based upon re-programming a type 1 Pakscan II, or IIE, Integral Field Unit.

1/ Connect your Paktester to the correct 2 wire loop terminals as shown in fig 1 on page 6.

2/ Switch on the Paktester and the following display should briefly appear;

```
FIELD TEST UNIT
PAK (1,2) V5.1
```

(Check that the version of software shown is V5.0 or higher)

followed by;

```
Select protocol
Pakscan 2
```

with the cursor flashing over the 2 indicating Pakscan II.

Ensure that the protocol displayed is correct for the Field Unit with which you are communicating. (The protocol can be altered between I and II by using either the "up arrow" or "down arrow" key).

3/ Once the correct protocol has been selected press the SYSTEM STATUS key and the display will now show;

```
Baud Rate = 1200
Add=001Mode=dig
```

with the cursor flashing over the "1" in the 1200.

(The address displayed will either be the address last programmed into the Field Unit or ADD = AU will appear)

4/ If an address does not automatically appear, i.e. ADD = AU is displayed, change the Paktester Baud rate by pressing the "up arrow" or "down arrow" keys, pausing briefly at each new rate, until an address appears.

If there is still no address after all the Baud rates have been tried, check that the wiring between the FCU and Paktester is correct, and if necessary ensure the correct Pakscan protocol has been chosen by switching the Paktester off and on again and re-selecting the correct protocol.

5/ Once an address has appeared, check to see if any alarms are present by pressing the FIELD ALARMS key, where any alarms present will be displayed as flashing letters. (The loopback alarm, a flashing L, will always be present as the FCU has to be in loopback to talk to the Paktester).

Any alarms present, except the L alarm, have to be cleared before the FCU can be re-programmed. To clear the alarms press the ALARM ACCEPT key. Any alarms still present after pressing the key can be investigated with the help of the code written below the display.

6/ Pressing the PROG key will now give you the option of entering new Baud rates and addresses via the following screen;



```
New B/Rate =1200
& Address =001
```

with the cursor flashing over the top = sign.

By pressing the "up arrow" or "down arrow" keys a new Baud Rate can be selected. Likewise by pressing the SELECT key followed by "up arrow" or "down arrow" keys the address can be altered.

7/ Once the correct values have been set, press the PROG key once more and the following should appear;

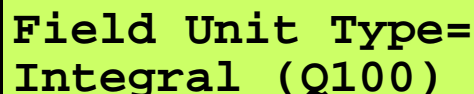

```
Field Unit Type=
Integral (Q100)
```

8/ Press the PROG key again and the following instruction will be displayed;

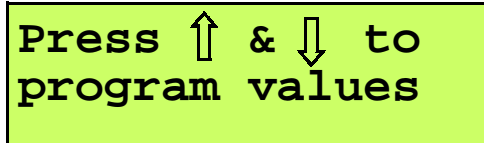

Press ↑ & ↓ to
program values

Press the "up arrow" and "down arrow" keys **together**, and the following message will then briefly appear.

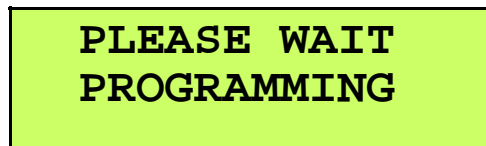

PLEASE WAIT
PROGRAMMING

followed by;

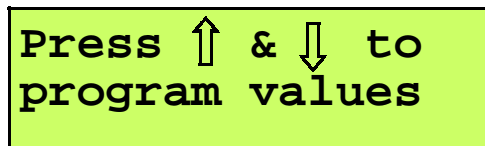

Press ↑ & ↓ to
program values

9/ Turn the Paktester off and then on again. Then follow steps 1 to 4 to prove that the new address and/or baud rate have been successfully re-programmed.

A10 Auxiliary I/P Mask setting for an IQ

The bits AUX1 - 8 can be thought of in the following way;

	AUX4 – 1 (Function)				AUX4 – 1 (Invert)			
Bits	8	7	6	5	4	3	2	1
	X	X	X	X	X	X	X	X

However, on the Paktester the mask will appear in the form;

AUX4>	X	X	X	X	<1	This line corresponds to bits 8 – 5, i.e. Function
	X	X	X	X		This line corresponds to bits 4 – 1, i.e. Invert

If AUX1 - 4 are to be used for remote I/P's they have already been designated as follows;

AUX1 - OPEN
AUX2 - CLOSE
AUX3 - STOP / MAINTAIN
AUX4 - ESD

Rules:

1/ Function bit set to 0

- Any function bit set to a "0" indicates that the particular aux I/P is to be treated as a digital signal to be passed on to the master station.
- If the corresponding invert bit is set to a "0", the signal is inverted before being passed on to the master station.
- If the corresponding invert bit is set to a "1", the signal is not inverted before being passed on to the master station.

2/ Function bit set to 1

- Any function bit set to a "1" indicates that the particular aux I/P is to be treated as a digital command to operate the actuator. The command signal will also be passed on to the master station
- When the corresponding invert bit is set to a "0", this represents a N.C. contact as being the command source, i.e. an open contact generates a command.
- When the corresponding invert bit is set to a "1", this represents a N.O. contact as being the command source, i.e. a closed contact generates a command.

3/ Standard hard-wiring ESD condition

- When used with an option card, such as Pakscan, the auxiliary inputs should not be wired as shown in the “remote control circuits” (form A to F). This is because both the control type (push to run or maintained) and input (N.O. or N.C.) are determined by the auxiliary input mask
- When using ESD (aux I/P 4) the ESD contact mode setting on the IQ (A3) should be set to the default value of “NO”. The A1 - ESD enable setting should be “ON” and the A2 - ESD direction should be set to either open or close

Examples

Example 1:

AUX1 - 4 are to be used to feed digital information over the 2 wire loop to the host, via the master station. Inputs 2 and 3 need to be inverted to give a “1” to the host when the actual input is a “0”.

Aux 4>	0	0	0	0	<1
	1	0	0	1	

IQ setting tool option
PF = 09

Example 2:

AUX1 - 4 are to be used as remote I/P's to control the actuator. The OPEN, CLOSE and ESD I/P's are NO and the STOP/MAINTAIN I/P is NC

Aux 4>	1	1	1	1	<1
	1	0	1	1	

IQ setting tool option
PF = FB

Note: With the Stop / Maintain line set to 0, the OPEN, CLOSE and ESD commands are “maintained”. If the Stop / Maintain were set to 1 the OPEN, CLOSE and ESD commands would be “push to run”, i.e. the actuator will stop when the input is de-energised.

Example 3:

AUX1 - 2 are to be used as remote I/P's to OPEN and CLOSE the actuator. The OPEN and CLOSE I/P's are NO. AUX3 - 4 are to be used to feed digital information, which needs to be inverted, to the host.

Aux 4>	0	0	1	1	<1
	0	0	1	1	

IQ setting tool option
PF = 33

Note: With this option the open and close commands are maintained.

For further information on the IQ mask, see the “Remote Auxiliary Input Mask” section in the IQ Field Unit Manual S172E.

Rotork Controls Ltd

Bath, England.

BA1 3JQ

tel: (01225) 428451

fax: (01225) 333467

Rotork Controls Inc

675 Mile Crossing Blvd,

Rochester,

New York 14624,

USA

tel: (716) 328 1550

fax: (716) 328 5848