

rotork[®]

Keeping the World Flowing

CK Range

CK_C & CK_{RC} - Centronik Start Up Guide



Modular Design Electric Valve Actuators

Contents

Section	Page	Section	Page
CK – Valve Actuation	2	Centronik Interface	4
CKc and CKRc – Centronik Quick Start Guide	3	Using the Product	4
		Basic Settings – Local Controls	6
		Basic Settings – Setting Tool	7
		Basic Settings – Digital Switch Mechanism	8
		Basic Settings – Mechanical Switch Mechanism	11
		CK Additional Indication Drive	18
		Basic Settings	18

CK – Valve Actuation

CK actuators have been developed with over 60 years of experience in actuation solutions. Our valve actuation products range from standard mechanical actuators to advanced digital actuators with integral controls.

Rotork has an extensive product range catering for all industries. Our actuation solutions deliver state-of-the-art performance, value and reliability to the global valve industry. We can help you through the process of product selection and specification from the installation of a single actuator up to complex system integration.

With an international network of offices and distributors we can fully support customer and end user requirements. Over 1,000 service technicians are employed by our company, partners and representatives, providing the necessary worldwide infrastructure to fully support actuators in the field.

Worldwide coverage

Our extensive international network enables us to think globally and act locally when it comes to supporting our customers. Rotork provides an efficient sales service, after sales commissioning and maintenance support throughout the life of the actuator.

Global manufacturing

Product reliability and integrity are priorities in CK product development. Our quality control teams source components from suppliers throughout the world to ensure our customers always receive first class actuation solutions.

Customer support

Rotork provide service support solutions to maximise your productivity and reduce your operational risk.

Information about this manual

The information and instructions included in this manual are applicable for all CKc and CKRc actuators. For information or instructions on other CK Range actuators please visit www.rotork.com

CK range





Centronik Controls

- A IrCK Transmitter / Receiver
- B Open
- C Close
- D Remote
- E Stop
- F Local

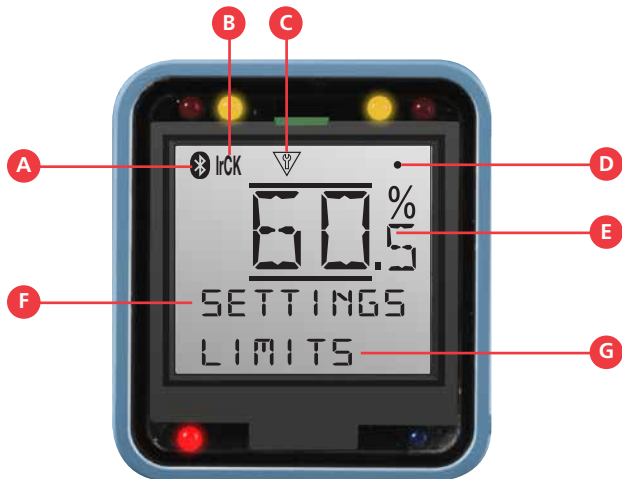

Centronik Interface

- A Bluetooth® Connection
- B Infrared Connection
- C Configuration Mode
- D Communication Feedback
- E Valve Position
- F Current Menu
- G Sub Menu / Setting Value

Centronik Interface – Using the Product

The Centronik Control Module can be configured using two different input methods. An optional Rotork Bluetooth® Setting Tool *Pro* provides a handheld solution compatible with Infrared or optional Bluetooth communication.

Alternatively the local selector knobs can be used to navigate in the same way. Be sure to read and understand the equivalent input commands. Instructions included in this manual are provided as shorthand symbols shown below.



Navigate to previous item within the current menu / decrease value / toggle setting



Exit to previous menu / exit setting change



Navigate to next item within the current menu / increase value / toggle setting



Enter menu / confirm selection / edit setting / save setting value / return to home screen*



Navigate to previous menu / decrease value / toggle setting / delete character*



Navigate to next menu / increase value / toggle setting / confirm character*



* Hold selector position for 3 seconds to special input function.

⏪	Read Only	⏩
⬅	Both Directions	➡
[First Menu	➤
⬅	Last Menu]

Interface Feedback

The Centronik display interface includes various features that provide feedback to the operator. This ensures that changes to the configuration of the actuator can be confirmed and validated during the commissioning process.

Arrow Identification

During general menu navigation, each submenu/setting will have a set of behaviour arrows associated with it. This lets the operator know what can be achieved on the current screen.

Solid blocks on the setting/menu indicate navigation is not possible. The function is read only.

Arrows on the menu/setting indicate navigation is possible – both directions. The function is in edit mode.

An inverse arrow on the left indicates you are viewing the first menu/setting or the lowest value.

An inverse arrow on the right indicates you are viewing the last menu/setting or the highest value.



Confirmation Feedback

Whilst modifying settings or navigating through the various Centronik interface menus, it is important to recognise that a change has been accepted or saved.

A small confirmation dot will be shown in the top right corner of the display if a valid input command has been recognised by the Centronik interface.

For each movement, the confirmation dot will only be shown once the Open/Close selector returns to the default rest position.

Centronik Interface – Basic Settings – Local Controls

Entering Configuration mode

To access configuration mode with the local selectors, input the following sequence:



Each command input must be completed within 1 second of the last and the selector knob must return to its default rest position between each input.

Entering the User Password

The password entry process involves the same basic steps as any other setting within the Centronik configuration.

First you will be presented with the current setting value as a read only item (see Fig. 1). This is indicated with a solid block either side of the value.



Fig. 1 Default password shown as read only.

By default, all Centronik Control modules will be configured with the user level password: ROTORK

Press to confirm this entry or use to enter a different password. For instruction on changing the user password, refer to PUB111-005.

The arrow behaviour will indicate the setting value is in edit mode and blank spaces will also be filled (see Fig. 2).



Fig. 2 Default password shown in edit mode.

Confirm ROTORK as the password by inputting .

Once the correct password has been entered, a confirmation message will appear to indicate the current access level (see Fig. 3).



Fig. 3 Default password entered and access level confirmed as User.

Exit to the main menu by inputting .

There is a symbol assigned to each access level for Centronik configuration changes. This will be displayed to the left of the position value for the duration of the session. Each confirmation message provides a visual prompt to correlate the symbol to an access level.

The symbol shown to the left side of the display will reference the following permission levels:

- User level permission to provide basic access to settings for commissioning and configuration purposes.
- Super User level permission to provide access to more advanced setting features.
- Service level permission to access Rotork Engineer settings.



Entering Configuration mode

To access configuration mode with the Rotork Bluetooth® Setting Tool *Pro*, ensure the actuator is in Local or Stop mode and point the setting tool directly at the IrCK LED.

Press to initiate communication. The IrCK symbol will be shown when an input from the Rotork Bluetooth® Setting Tool *Pro* is registered by the Centronik Control Module.

If the optional Bluetooth module is fitted, the setting tool will begin communication through IrCK until a secure Bluetooth link has been established. To confirm a Bluetooth connection has been successful, the top left symbol on the Centronik display will change from IrCK to and the Rotork Bluetooth® Setting Tool *Pro* button will illuminate solid blue.

⚠ For IrCK communication, the Rotork Bluetooth® Setting Tool *Pro* must be aligned to the IrCK LED at all times.



Entering the User Password

The password entry screen will be displayed with the default password visible. Press to confirm this entry or use to enter a different password. For instruction on changing the user password, refer to PUB111-005.

Blank spaces will fill with whilst modifying the password text.

Once a valid password has been entered the display will show the current active permission level with a symbol and text.

Press to return to the main menu.

Actuator settings cannot be modified in Remote.

The symbol shown to the left side of the display will reference the following permission levels:

- User level permission to provide basic access to settings for commissioning and configuration purposes.
- Super User level permission to provide access to more advanced setting features.
- Service level permission for Rotork Engineer access only.

Centronik Interface – Basic Settings – Digital Switch Mechanism

The menu map below provides direction for the basic setting and commissioning of a CKc or CKRc actuator equipped with a Digital Switch Mechanism and Centronik Control Module.

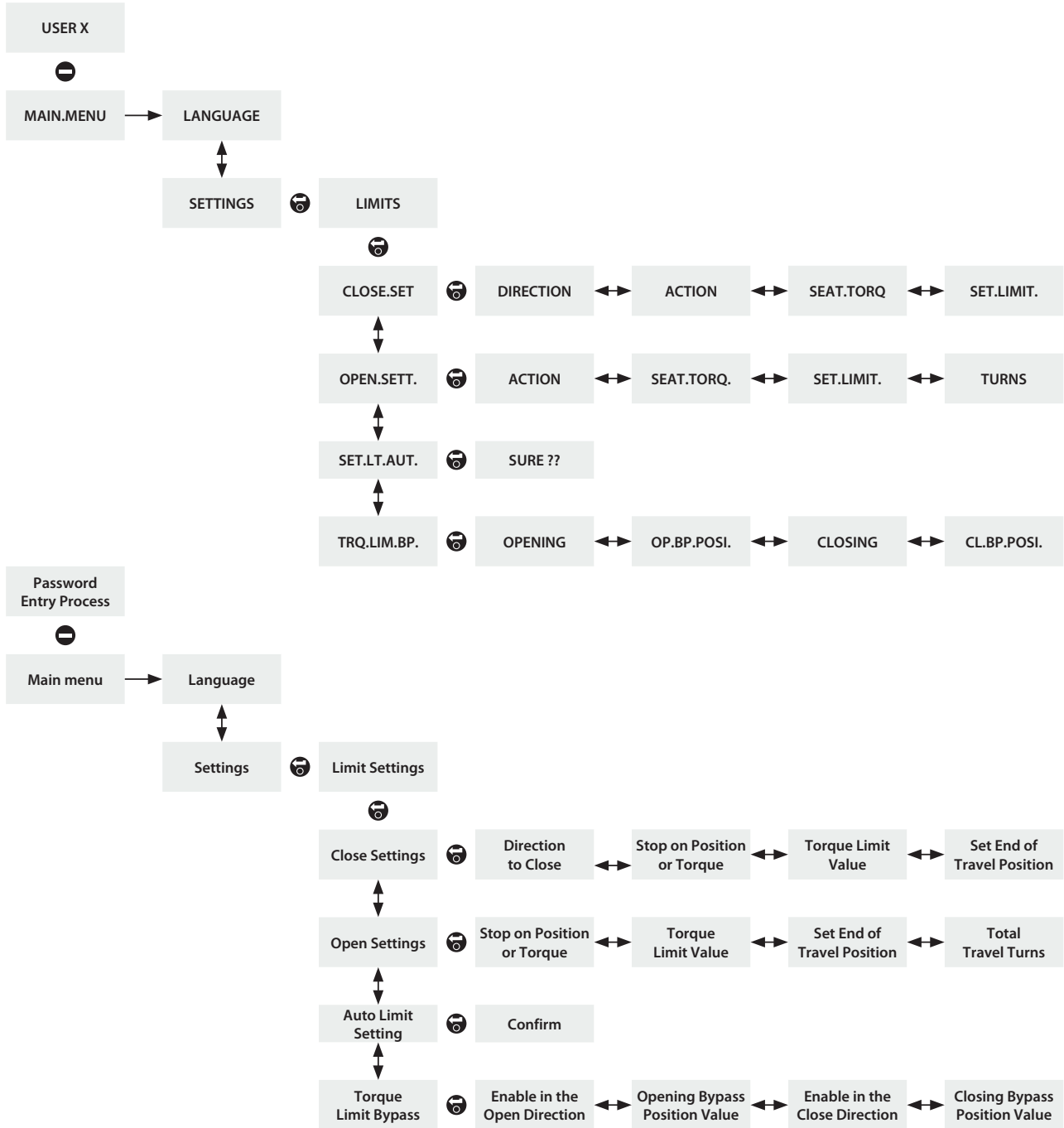

Centronik Interface – Basic Settings – Digital Switch Mechanism





Main Menu > Settings > Limits

The Limits menu details all of the appropriate settings to control the conditions for stopping actuator movement.





Use the menu map on the previous page to follow the menu structure through to the [LIMITS] sub menu.

Limits > Close Settings [CLOSE.SET.]





Direction to Close [DIRECTIO.]

Press  to edit, select preferred option using  and  for Clockwise or Anti-clockwise operation and press  to save selection.

Action [ACTION]

Press  to edit, select preferred option using  and  for Seat Limit or Seat Torque and press  to save selection.

Seating Torque [SEAT.TORQ.]

Press  to edit, adjust shown value using  and  and press  to confirm selection (40% - 100%).

 **CAUTION: The Seating Torque value is used as torque limit protection through full valve travel.**

Setting the Close Position Limit [SET.LIMIT.]

Move the actuator to the fully closed position. Allow for overrun by winding the manual override handwheel in the open direction by 5 turns (10 turns for CK500).

Press  to edit.





[SURE??] will show on the display, press  to confirm.

Once these steps are complete, the Centronik display position should replicate the image below.







Limits > Open Settings [OPEN.SETT.]

Action [ACTION]

Press  to edit, select preferred option using  and  for Seat Limit or Seat Torque and press  to save selection.

Seating Torque [SEAT.TORQ.]

Press  to edit, adjust shown value using  and  and press  to confirm (40% - 100%).

 **CAUTION: The Seating Torque value is used as torque limit protection through full valve travel.**

Turns [TURNS]

This setting will show the number of output turns configured for actuator / valve travel between the open and closed limit positions. This is a read only function to validate total valve travel.

Setting the Open Position Limit [SET.LIMIT.]

Move the actuator to the fully open position. Allow for overrun by winding the manual override handwheel in the close direction by 5 turns (10 turns for CK500).

Press  to edit.

[SURE??] will show on the display, press  to confirm.



Once these steps are complete, the Centronik display position should replicate the image below.



Centronik Interface – Basic Settings – Digital Switch Mechanism

Limits > Auto Set Limits [SET.LT.AUT.]

The actuator position limits can automatically be configured using the valve end of travel stops as references. This is an automated process that detects end of travel positions using 40% torque.

Press  to enter the auto limit menu. Select LOCAL on the control selector and press  to start the auto set limit process. The actuator will operate in both directions until 40% torque is registered. Limit positions will be set at these points for the relevant direction of travel. The process can be stopped at any point by switching to STOP with the control selector.



 **CAUTION: This feature should only be used for applications that have travel stops for both ends of travel (torque/torque). Do not use the auto set limit function if one or more of the valve limit positions can be surpassed.**



Limits > Torque Limit Bypass [TRQ.LIM.B.P.]

Occasionally applications will require a break to open or break to close torque that exceeds the standard torque limit. Setting the torque limit bypass will ignore existing torque limit settings and apply maximum torque (up to approximately 150% or rated) across a predetermined portion of travel.

 **CAUTION: The valvemaker / integrator should be consulted to confirm the valve structure and interface components can withstand the additional torque/thrust.**





Torque Limit Bypass

The [OPENING] and [CLOSING] settings will enable torque limit bypass for the relevant direction of travel, use   and  to enter the setting sub menu.





Press  to edit, select [ON] or [OFF] and press  to save selection.

Torque Limit Bypass Position

The [OP.BP.POSI.] value dictates the travel away from the closed position limit that the torque limit will be bypassed in the open direction.

Press  to edit, adjust shown value using  and  and press  to save selection. E.g. setting at 5% will bypass the torque limit between 0% and 5%.

The [CL.BP.POSI.] value dictates the travel away from the open position limit that the torque limit will be bypassed in the close direction.

Press  to edit, adjust shown value using  and  and press  to save selection. E.g. setting at 95% will bypass the torque limit between 95% and 100%.



Centronik Interface – Basic Settings – Mechanical Switch Mechanism

Test Feedback Switches

- 1) Confirm the torque or limit switches are functional by monitoring feedback on the Centronik display during switch testing.

⚠ The main power supply must be maintained during this test procedure to ensure feedback via the Centronik display.

It is not possible to test a switch that is already actuated by the mechanism (for instance, at the end of travel limits). To ensure that all switches can be tested correctly, move the actuator to a mid-travel position and confirm that none of the switches are active before beginning the test procedure.

- 2) Test position switches in both directions using a flat screwdriver to turn LS TEST. Clockwise (CW) for open and anti-clockwise (ACW) for close. Feedback that the switch state has changed will be seen on the Centronik display interface.

The status text (top line) will show CLOSE.LIM. or OPEN LIM. and the status LEDs will change from yellow (mid travel) to red or green depending on user settings.

To confirm the normally closed control switch statuses, navigate to the following menu within the Centronik software.

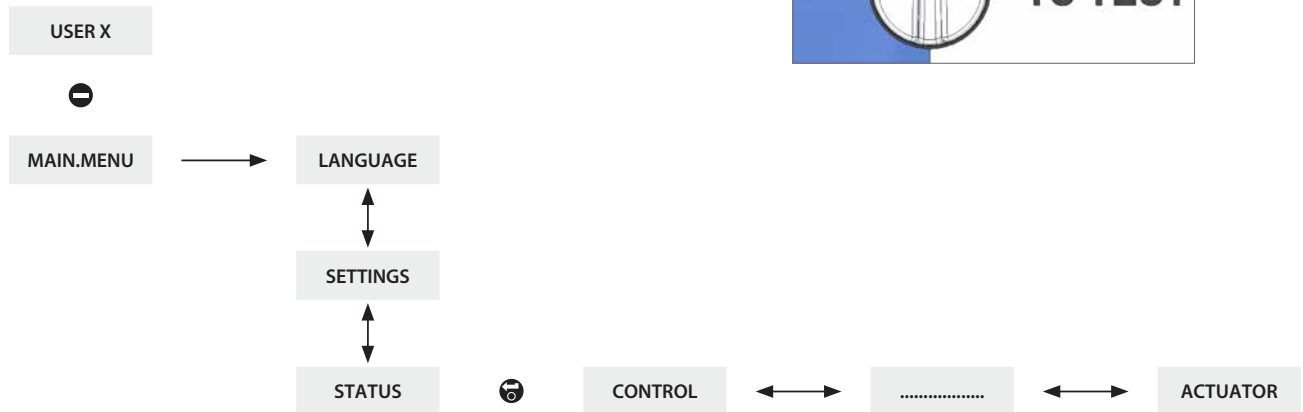

The end character displays the current status of the switch.

CLS.LIMI.X. indicates the switch has been made. As the control switches are normally closed contact form, CLS.LIMI.X. should be the status throughout travel until the closed limit has been reached.

CLS.LIMI.0. will then be displayed.

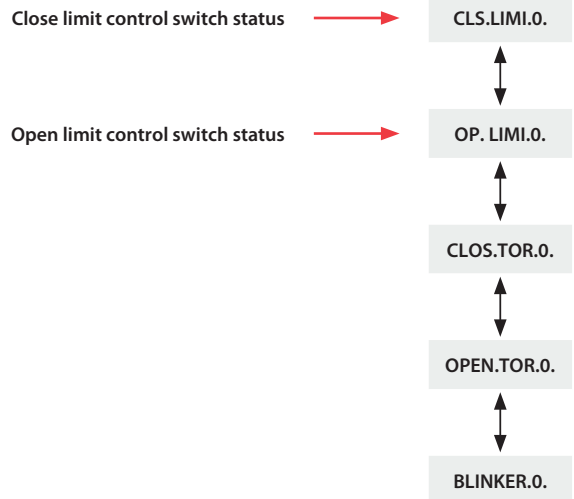

Centronik Interface – Basic Settings – Mechanical Switch Mechanism

Test Feedback Switches

- Test torque switches in both directions using a flat screwdriver to turn TS TEST (ACW for open, CW for close). Feedback that the switch state has changed will be seen on the Centronik display interface.

The status text (bottom line) will show TRQ.T.CLOS. or TRQ.T.OPEN and the alarm status LED will illuminate red.

To confirm the normally closed control switch statuses, navigate to the following menu within the Centronik software.

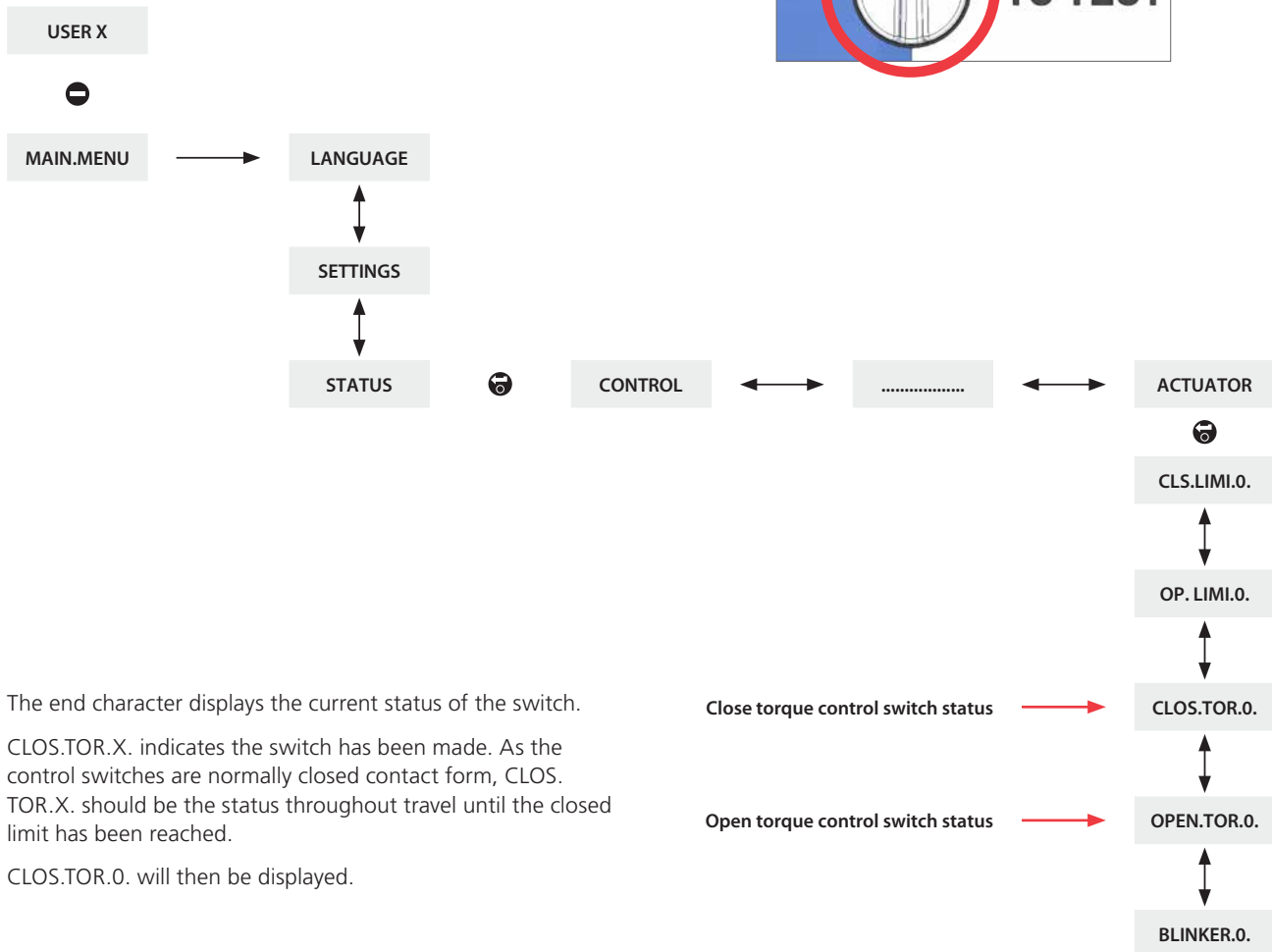
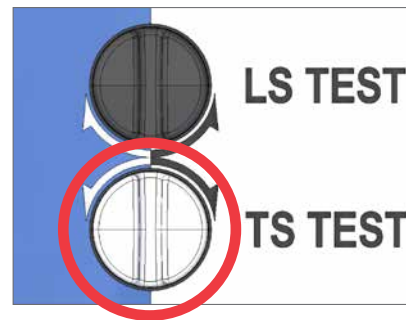

The end character displays the current status of the switch.
 CLOS.TOR.X. indicates the switch has been made. As the control switches are normally closed contact form, CLOS.TOR.X. should be the status throughout travel until the closed limit has been reached.
 CLOS.TOR.0. will then be displayed.

Centronik Interface – Basic Settings – Mechanical Switch Mechanism

A 5 mm Allen (Hex.) key and 0.8 x 4 mm flat screwdriver are required to perform commissioning of the CK Mechanical Switch Mechanism.

Set torque limits

- A Indicator/Adjustment Point
- B Torque Cam Clutch Screw



- 1) Move the valve to a mid-travel position and loosen the Torque Cam Clutch 1.5 turns using a flat screwdriver.



- 2) Adjust each Torque Cam to the desired value (between min. & max.) by moving the cam using a screwdriver on the adjustment point.



⚠ CAUTION: Ensure the screwdriver remains perpendicular to the switch mechanism faceplate when adjusting the torque trip limits to avoid introducing an offset to the set value.

Centronik Interface – Basic Settings – Mechanical Switch Mechanism

C Open Torque Adjustment Point

D Close Torque Adjustment Point

- 3) Tighten the Torque Cam Clutch Screw once both torque trip limits have been set.

⚠ CAUTION: Ensure the Torque Cam Clutch Screw is tightened enough to fully deform the spring washer underneath the screw head.

E Factory Calibration Fixings

⚠ WARNING: Do not adjust the fixings or position of the yellow torque indicator plates. These are factory configured for 40-100% adjustment of the actuator torque and under no circumstances should be moved.

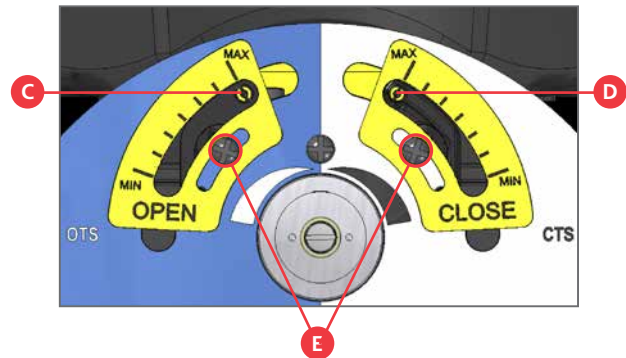

Centronik Interface – Basic Settings – Mechanical Switch Mechanism

Set Position Limits

- F OLS Indicator Window
- G OLS Adjustment Screw
- H Drive Clutch Shaft
- I CLS Indicator Window
- J CLS Adjustment Screw

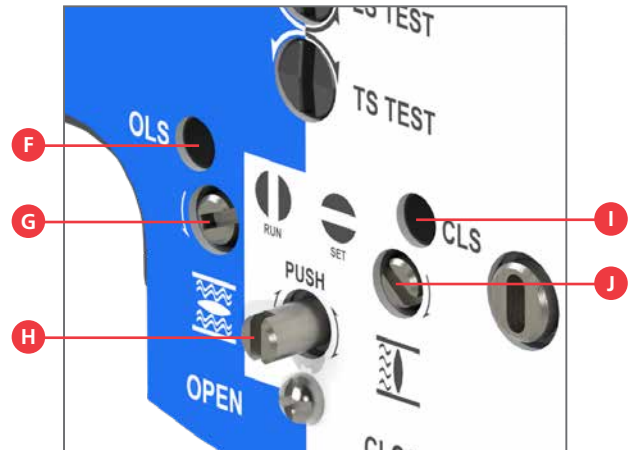

- 1) Move actuator to the valve CLOSED position using handwheel operation.
- 2) Using a flat screwdriver, depress the Drive Clutch Shaft and rotate to "SET" position as shown on the switch mechanism faceplate.
- 3) The CLS Adjustment Screw must now be rotated to make the closed limit switch inside the switch mechanism. The CLS Indicator Window will show one of four possible symbols. Please refer to Figure 1 on page 16 for direction input.
- 4) Depending on where the mechanism is in the cycle, it is possible that the switch will be approached from the wrong direction, in which case it is necessary to move through the limit and approach it from the correct direction. This is done to avoid the need to wind through the whole mechanism to reach the limit position. The correct direction to approach the limit is shown by the arrow next to the Adjustment Screw input.
- 5) Perform two checks to confirm the CLOSED limit position switch has been made correctly.
 - a. The feel of the Adjustment Screw will noticeably change providing more mechanical resistance at the switching point of the contact.
 - b. Confirm the switch has been made by checking the CLOSED limit symbol is shown on the Centronik display.
- 6) Using a flat screwdriver, depress the Drive Clutch Shaft and rotate to "RUN" position as shown on the switch mechanism faceplate.
- 7) Rotate the CLS and OLS Adjustment Screws a small amount in both directions to re-engage the mechanism drive. A click will be heard as the drive drops back into engagement and the adjustment screws will no longer move in either direction.

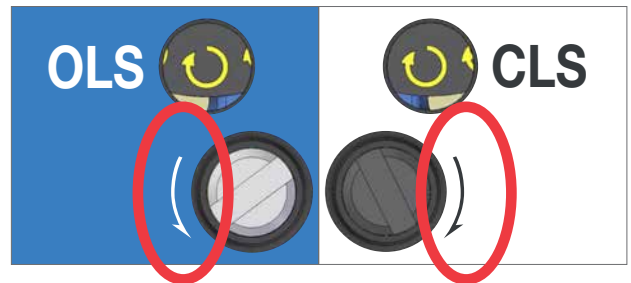

⚠ This must be done or the limit will be lost when the actuator is moved.

Centronik Interface – Basic Settings – Mechanical Switch Mechanism

- 8) Move actuator to the valve OPEN position using handwheel operation.
- 9) Using a flat screwdriver, depress the Drive Clutch Shaft and rotate to "SET" position as shown on the switch mechanism faceplate.
- 10) The OLS Adjustment Screw must now be rotated to make the open limit switch inside the switch mechanism. The OLS Indicator Window will show one of four possible symbols. Please refer to Figure 1 below for direction input.
- 11) Depending on where the mechanism is in the cycle, it is possible that the switch will be approached from the wrong direction, in which case it is necessary to move through the limit and approach it from the correct direction. This is done to avoid the need to wind through the whole mechanism to reach the limit position. The correct direction to approach the limit is shown by the arrow next to the Adjustment Screw input.
- 12) Perform two checks to confirm the OPEN limit position switch has been made correctly.
 - a. The feel of the Adjustment Screw will noticeably change providing more mechanical resistance at the switching point of the contact.
 - b. Confirm the switch has been made by checking the OPEN limit symbol is shown on the Centronik display.
- 13) Using a flat screwdriver, depress the Drive Clutch Shaft and rotate to "RUN" position as shown on the switch mechanism faceplate.
- 14) Rotate the OLS and CLS Adjustment Screws a small amount in both directions to re-engage the mechanism drive. A click will be heard as the drive drops back into engagement and the adjustment screws will no longer move in either direction.

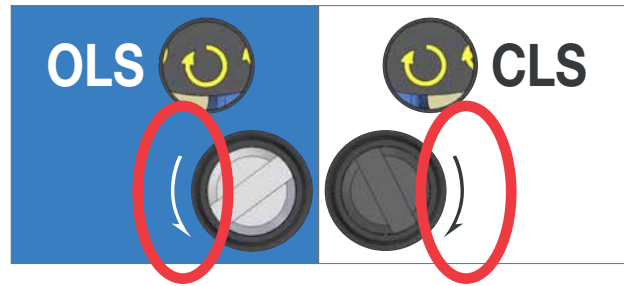

⚠ This must be done or the limit will be lost when the actuator is moved.

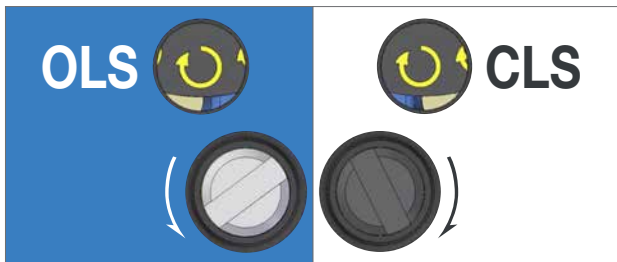

Rotate the OLS/CLS Adjustment Shaft Clockwise.

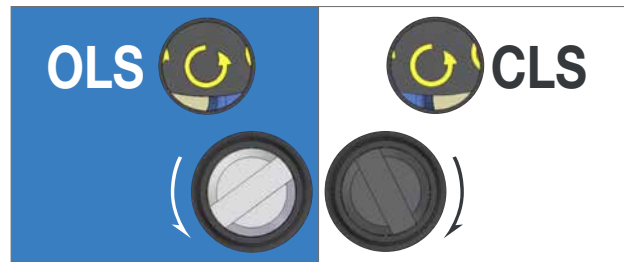

Rotate the OLS/CLS Adjustment Shaft Anti-Clockwise.

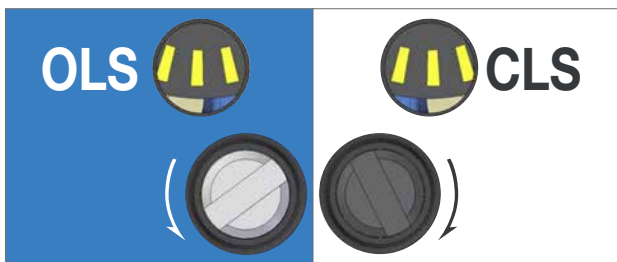

Rotate the OLS/CLS Adjustment Shaft In the direction shown next to the Shaft input.

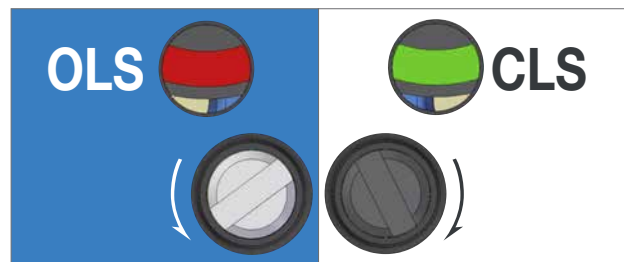

The limit switching point is near or made.

Figure 1.

Centronik Interface – Basic Settings – Mechanical Switch Mechanism

For CKc or CKRc actuators fitted with a Mechanical Switch Mechanism, the required end of travel action (torque or position) is determined by the **[ACTION]** setting within the Centronik configuration. All other limit functions will not be available as they need to be intrusively set on the mechanism.

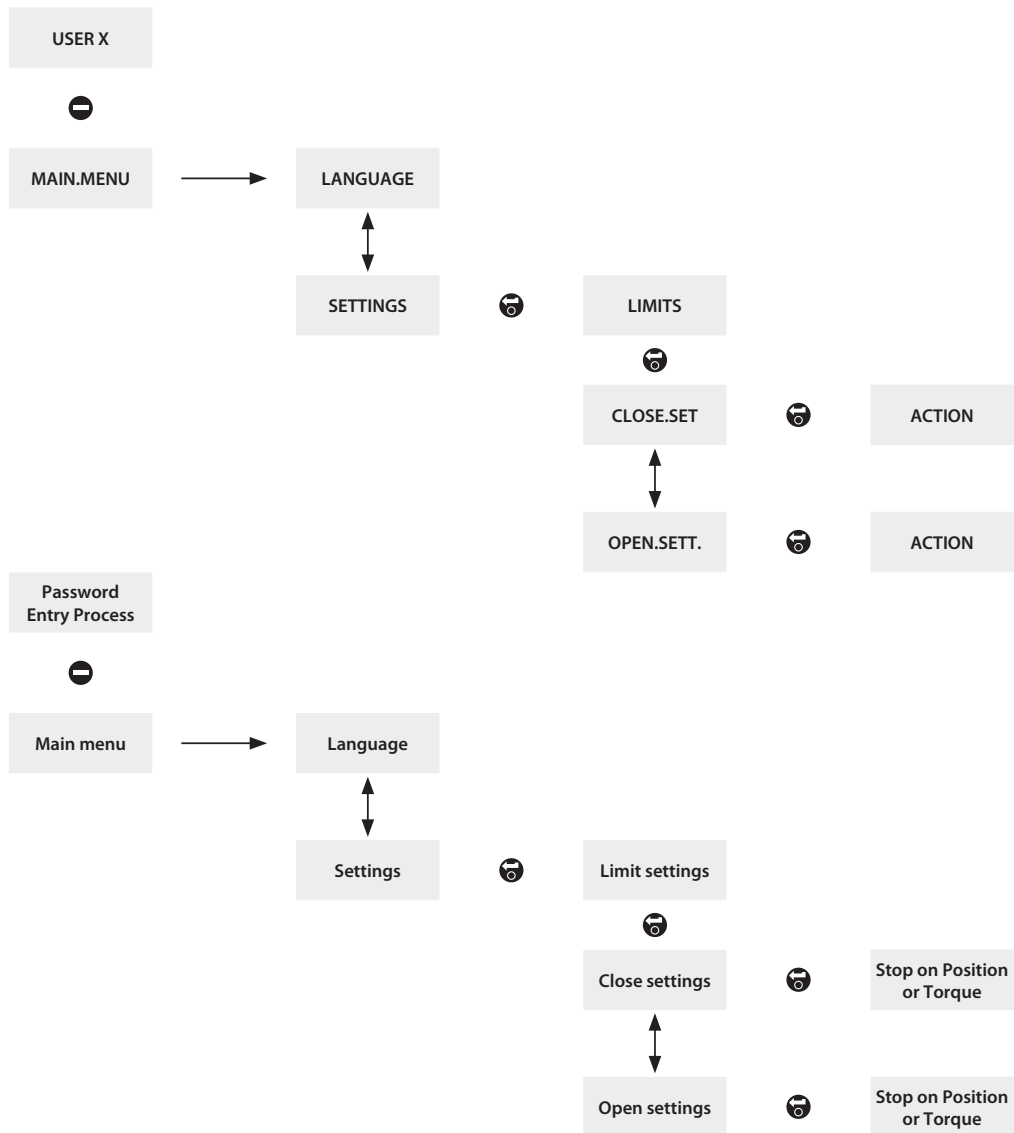

CK Additional Indication Drive – Basic Settings

Test Feedback Switches

- 1) Confirm the torque or limit switches are functional by monitoring feedback on the Centronik display during switch testing.

⚠ The main power supply must be maintained during this test procedure to ensure feedback via the Centronik display.

It is not possible to test a switch that is already actuated by the mechanism (for instance, at the end of travel limits). To ensure that all switches can be tested correctly, move the actuator to a mid-travel position and confirm that none of the switches are active before beginning the test procedure.

- 2) Test position switches in both directions using the LS TEST lever shown on the right side of the unit between the AID module and Mechanical Switch Mechanism (move DOWN for open, UP for close).

The status text (top line) will show CLOSE.LIM. or OPEN LIM. and the status LEDs will change from yellow (mid travel) to red or green depending on user settings.

To confirm the normally closed control switch statuses, navigate to the following menu within the Centronik software.

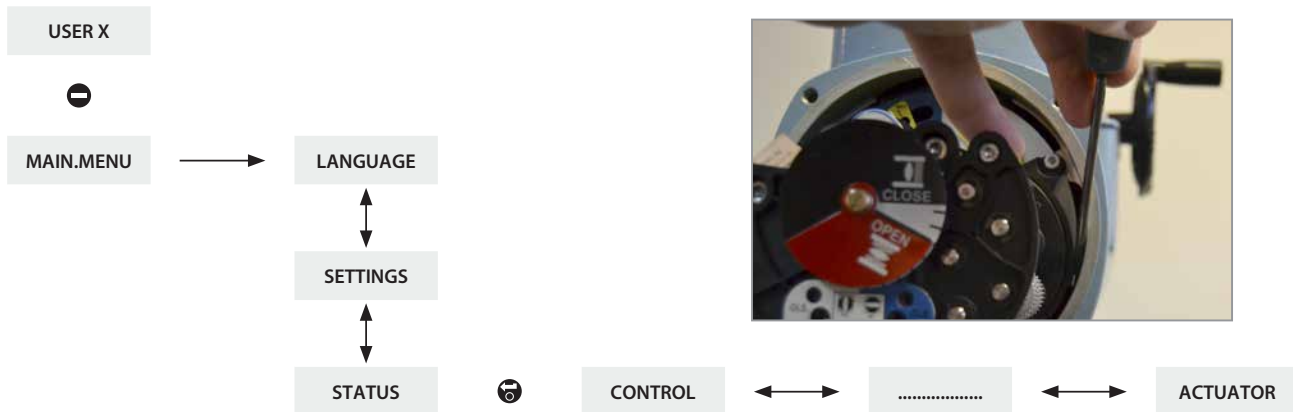

The end character displays the current status of the switch. CLS.LIMI.X. indicates the switch has been made. As the control switches are normally closed contact form, CLS.LIMI.X. should be the status throughout travel until the closed limit has been reached.

CLS.LIMI.0. will then be displayed.

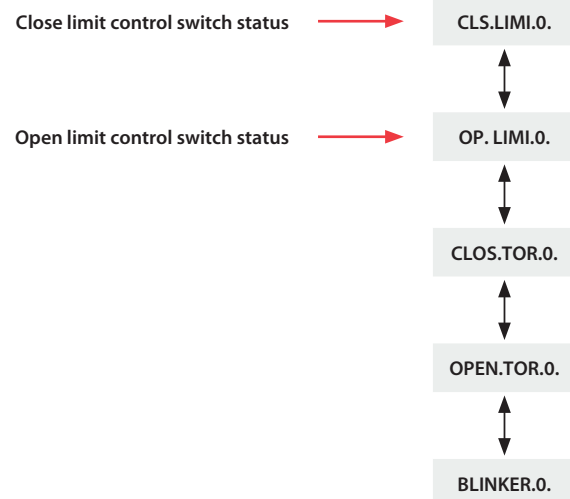

CK Additional Indication Drive – Basic Settings

Test Feedback Switches

- 3) Test torque switches in both directions using the TS TEST lever shown on the left side of the unit between the AID module and Mechanical Switch Mechanism (move DOWN for open, UP for close).

The status text (bottom line) will show TRQ.T.CLOS. or TRQ.T.OPEN and the alarm status LED will illuminate red.

To confirm the normally closed control switch statuses, navigate to the following menu within the Centronik software.

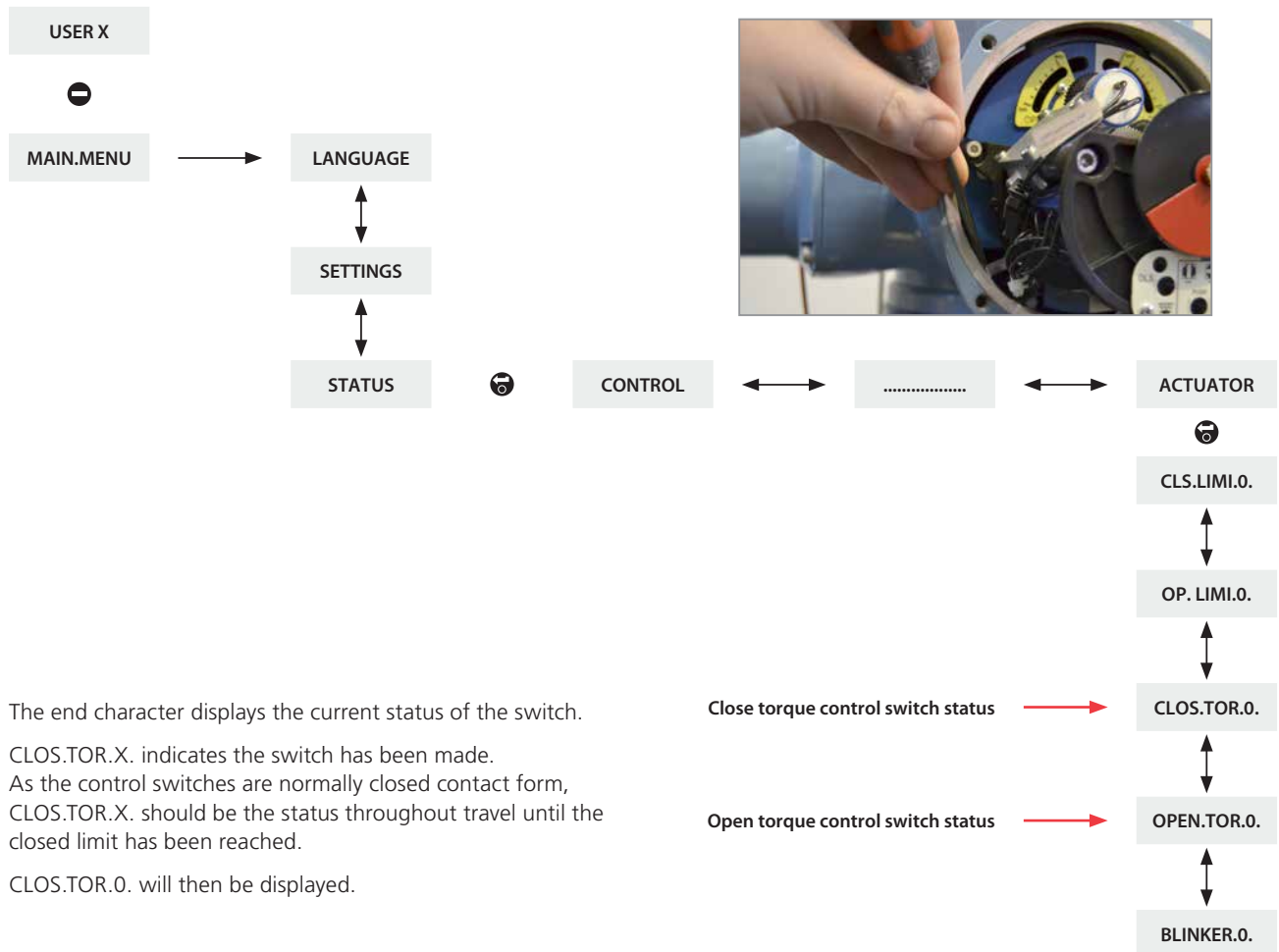

The end character displays the current status of the switch.
 CLOS.TOR.X. indicates the switch has been made.
 As the control switches are normally closed contact form, CLOS.TOR.X. should be the status throughout travel until the closed limit has been reached.
 CLOS.TOR.0. will then be displayed.

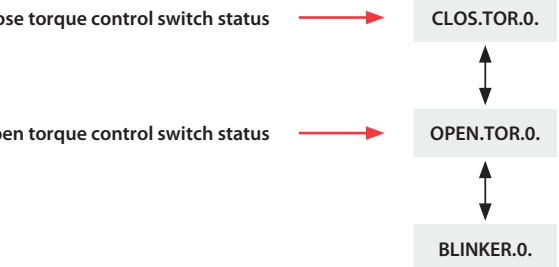

CK Additional Indication Drive – Basic Settings

Setting Local Position Disc

The AID module includes a Local Position Disc that should be configured to show Open and Close limit positions. A series of reduction gears ensure a suitable range of travel can be accommodated. If more turns are required please contact Rotork.

⚠ CAUTION: The actuator position limits must be configured prior to setting the Local Position Disc.

⚠ CAUTION: The AID cover orientation can be adjusted through 360° in 90° increments. If this is a requirement then the following instructions must be adjusted by the same increment in the same direction.

- 1) Move the actuator to the CLOSED limit using electrical operation or the handwheel.
- 2) Loosen off the Position Disc Retaining Screw by 1 turn.
- 3) Rotate the Position Disc so that CLOSE reads horizontally and hold the disc in place.
- 4) Tighten the Position Disc Retaining Screw until the Position Disc is firmly locked in place.
- 5) Confirm the CLOSE label is aligned correctly with the cover indication arrow.

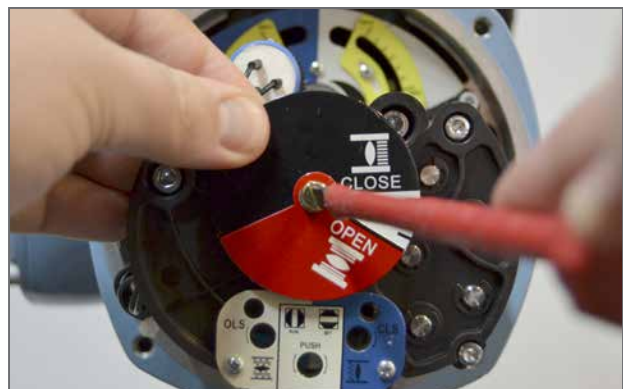
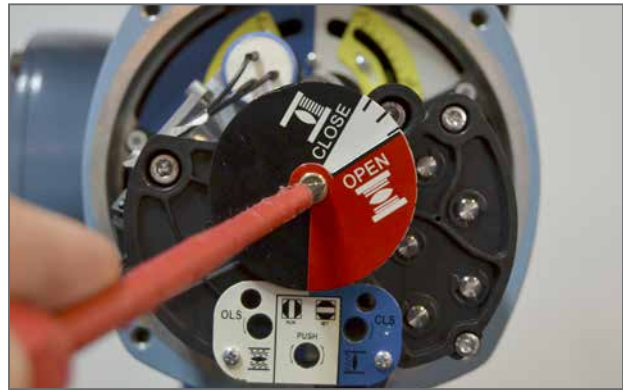

CK Additional Indication Drive – Basic Settings

- 6) Move the actuator to the OPEN limit using electrical or operation or the handwheel.



- 7) Loosen off the Position Disc Retaining Screw by 1 turn whilst holding the CLOSE portion of the Position Disc.
- 8) Rotate only the red OPEN portion of the disc so that OPEN reads horizontally and then hold both portions in place.



- 9) Tighten the retaining screw until the Position Disc is firmly locked in place.

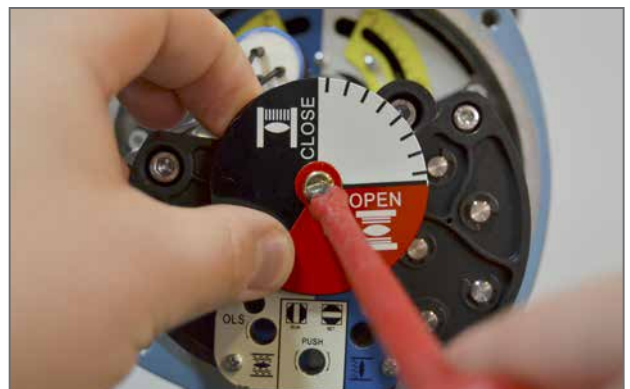

- 10) Confirm the OPEN label is aligned correctly with the cover indication arrow.



CK Additional Indication Drive – Basic Settings

Setting Intermediate Switches

The AID Module can include four additional switches to indicate configurable intermediate positions.

⚠ CAUTION: The actuator position limits must be configured prior to setting the Intermediate Switches.

- 1) Move the actuator to the desired intermediate position using electrical operation or the handwheel.
- 2) Move the switch cam along the shaft against the spring to allow free rotation of the cam.
- 3) Rotate the cam to ensure the desired switch behaviour is achieved. The intermediate position switches can be supplied with normally open or normally closed contact form.
- 4) Confirm the switch has been engaged/disengaged by measuring continuity across the relevant terminals during cam adjustment – refer to actuator wiring diagram and pictorial annotations (right) for the relevant switch information.
- 5) Repeat steps 1 to 4 for each intermediate position switch.

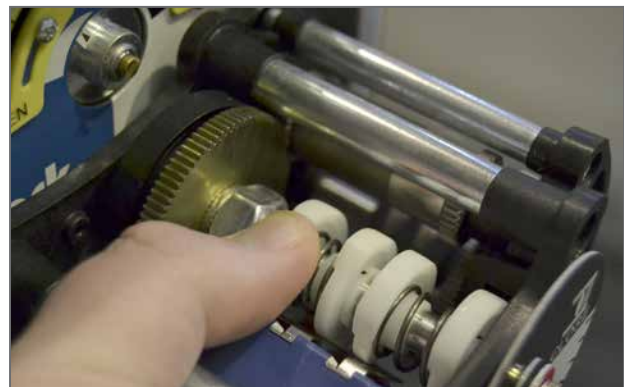
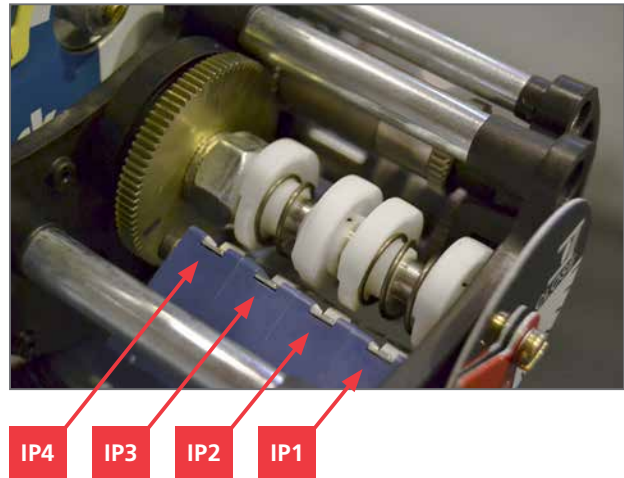

CK Additional Indication Drive – Basic Settings

Setting the POT

The AID Module can include a potentiometer to report intermediate position to the Centronik control module. This can also be used in parallel to a digital switch mechanism to provide a direct potentiometric output or a loop powered 4-20 mA scaled Current Position Transmitter option (refer to next page).

The POT drive includes four different sized gears that allow the single turn POT to be scaled according to the total valve travel. For information on which ratio is suitable for your application please contact Rotork.



⚠ CAUTION: The actuator position limits must be configured prior to setting the AID POT drive.

- 1) Loosen off the retaining grub screw using a 1.5 mm Allen (Hex.) Key.
- 2) Rotate the POT drive assembly away from the driving gear.
- 3) Move the actuator to the Closed Limit position using electrical operation or the handwheel.
- 4) Monitor position feedback on the Centronik display or if the POT output is separate to the Centronik then connect a test meter across the POT terminals* – refer to actuator wiring diagram and POT Setting Information table below.
- 5) Rotate the POT input gears until the Closed Limit is reported on the Centronik display or the measured resistance value has been reached.
- 6) Refit the POT assembly to the AID chassis and ensure the teeth mate correctly with the position drive gear.



⚠ CAUTION: Extra care must be taken to ensure the correct POT input gear is mated with the position drive gear.

- 7) Tighten the retaining grub screw to prevent movement of the POT drive assembly.
- 8) Move the actuator to the Open Limit position using electrical operation or the handwheel.
- 9) Follow instructions on page 9 to set the open limit position to calibrate the open position POT value.
- 10) Confirm the POT is triggering the Open Limit on the Centronik display or reading the required resistance value.
- 11) Follow instructions on page 9 to set the close limit position to calibrate the close position POT value.

⚠ CAUTION: Setting limits on the Centronik control module is required to automatically scale the POT values from 0 - 100%.

*Potentiometer terminals may not be accessible if the AID CPT option is also fitted. In this instance it is important to ensure the POT does not slip throughout full valve travel. Current should change through 4-20 mA however tuning may be required. Refer to the next page for tuning instructions.

POT Setting Information			
Travel Direction	Value at Closed Limit	Value at Open Limit	Measurement Terminals
Clockwise	Low	High	30 & 31
Clockwise	High	Low	31 & 32
Anti-Clockwise	Low	High	31 & 32
Anti-Clockwise	High	Low	30 & 31

CK Additional Indication Drive – Basic Settings

Setting the CPT

Once the POT drive is commissioned for full valve travel, the CPT can be calibrated to output a 4-20 mA loop powered signal. This can be used as direct actuator position feedback to the site control system or to transmit intermediate position to a remote mounted Centronik control module.

The CPT option includes two different trimming potentiometers to enable zero and span values to be calibrated.

⚠ CAUTION: The actuator position limits and POT drive must be configured prior to setting the AID CPT.

- 1) Run the actuator to the Closed position limit using electrical operation or the handwheel.
- 2) Monitor position feedback on the Centronik display or if the CPT output is separate to the Centronik then connect a powered test meter across the CPT terminals – refer to actuator wiring diagram.
- 3) Rotate the ZERO trimming potentiometer so that 4 mA is output from the CPT.
- 4) Run the actuator to the Open position limit using electrical operation or the handwheel.
- 5) Monitor position feedback on the Centronik display or if the CPT output is separate to the Centronik then connect a powered test meter across the CPT terminals – refer to actuator wiring diagram.
- 6) Rotate the SPAN trimming potentiometer so that 20 mA is output from the CPT.
- 7) Adjustment of the SPAN will cause the ZERO to change a small amount. It is important to repeat steps 1 to 6 a second time in order to remove this calibration error.

If CPT is providing position to the Centronik control module, fine tuning may not be necessary however the limit positions must be set to calibrate the CPT value for auto-scaling. Follow instructions on page 9 to set the OPEN and CLOSE limits.

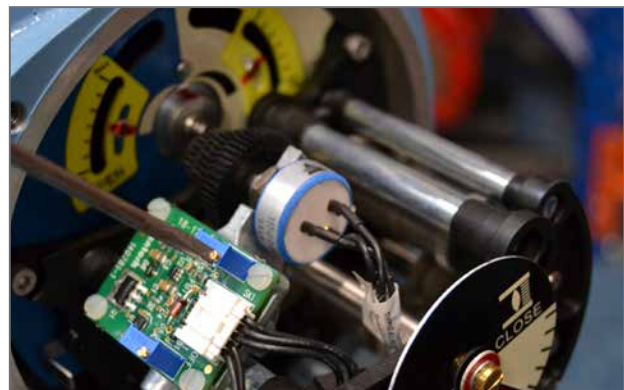
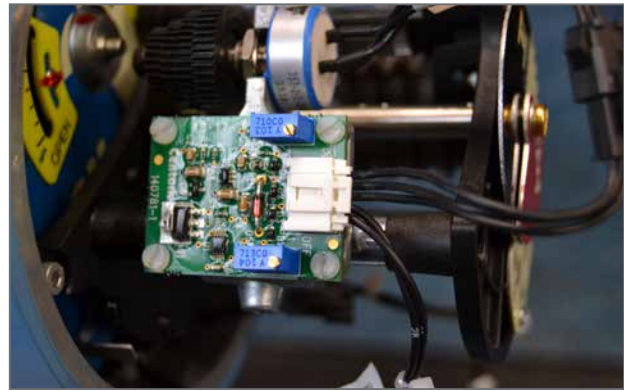

⚠ CAUTION: Setting limits on the Centronik control module is required to automatically scale the CPT values from 0 - 100%.

rotork®

Keeping the World Flowing



www.rotork.com

A full listing of our worldwide sales and service network is available on our website.

Rotork plc
Brassmill Lane, Bath, UK
tel +44 (0)1225 733200
email mail@rotork.com

Rotork is a corporate member of the Institute of Asset Management



PUB111-004-00
Issue 07/19

As part of a process of on-going product development, Rotork reserves the right to amend and change specifications without prior notice. Published data may be subject to change. For the very latest version release, visit our website at www.rotork.com

The name Rotork is a registered trademark. Rotork recognizes all registered trademarks. The Bluetooth® word mark and logos are registered trademarks owned by Bluetooth SIG, Inc. and any use of such marks by Rotork is under license. Published and produced in the UK by Rotork. POWTG0619