

rotork®

Keeping the World Flowing
for Future Generations

CK Range

CKA & CKRA – Atronik Start Up Guide



Modular Design Electric Valve Actuators

Contents

Section	Page	Section	Page
1. CK – Valve Actuation	2	3. Commissioning	4
2. Actuator Identification	3	3.1 Mechanical Switch Mechanism	4
		3.2 Additional Indication Drive	8
		4. CK Atronik	14
		4.1 Standard Settings	14
		4.2 Option Settings	15

1. CK – Valve Actuation

CK actuators have been developed with over 60 years of experience in actuation solutions. Our valve actuation products range from standard mechanical actuators to advanced digital actuators with integral controls.

Rotork has an extensive product range catering for all industries. Our actuation solutions deliver state-of-the-art performance, value and reliability to the global valve industry. We can help you through the process of product selection and specification from the installation of a single actuator up to complex system integration.

With an international network of offices and distributors we can fully support customer and end user requirements. Over 1,000 service technicians are employed by our company, partners and representatives, providing the necessary worldwide infrastructure to fully support actuators in the field.

Worldwide coverage

Our extensive international network enables us to think globally and act locally when it comes to supporting our customers. Rotork provides an efficient sales service, after sales commissioning and maintenance support throughout the life of the actuator.

Global manufacturing

Product reliability and integrity are priorities in CK product development. Our quality control teams source components from suppliers throughout the world to ensure our customers always receive first class actuation solutions.

Customer support

Rotork provide service support solutions to maximise your productivity and reduce your operational risk.

Information about this manual

The information and instructions included in this manual are applicable for all CKA and CKRA actuators. For information or instructions on other CK Range actuators please visit www.rotork.com

CK range



2. Actuator Identification

CKA Atronik

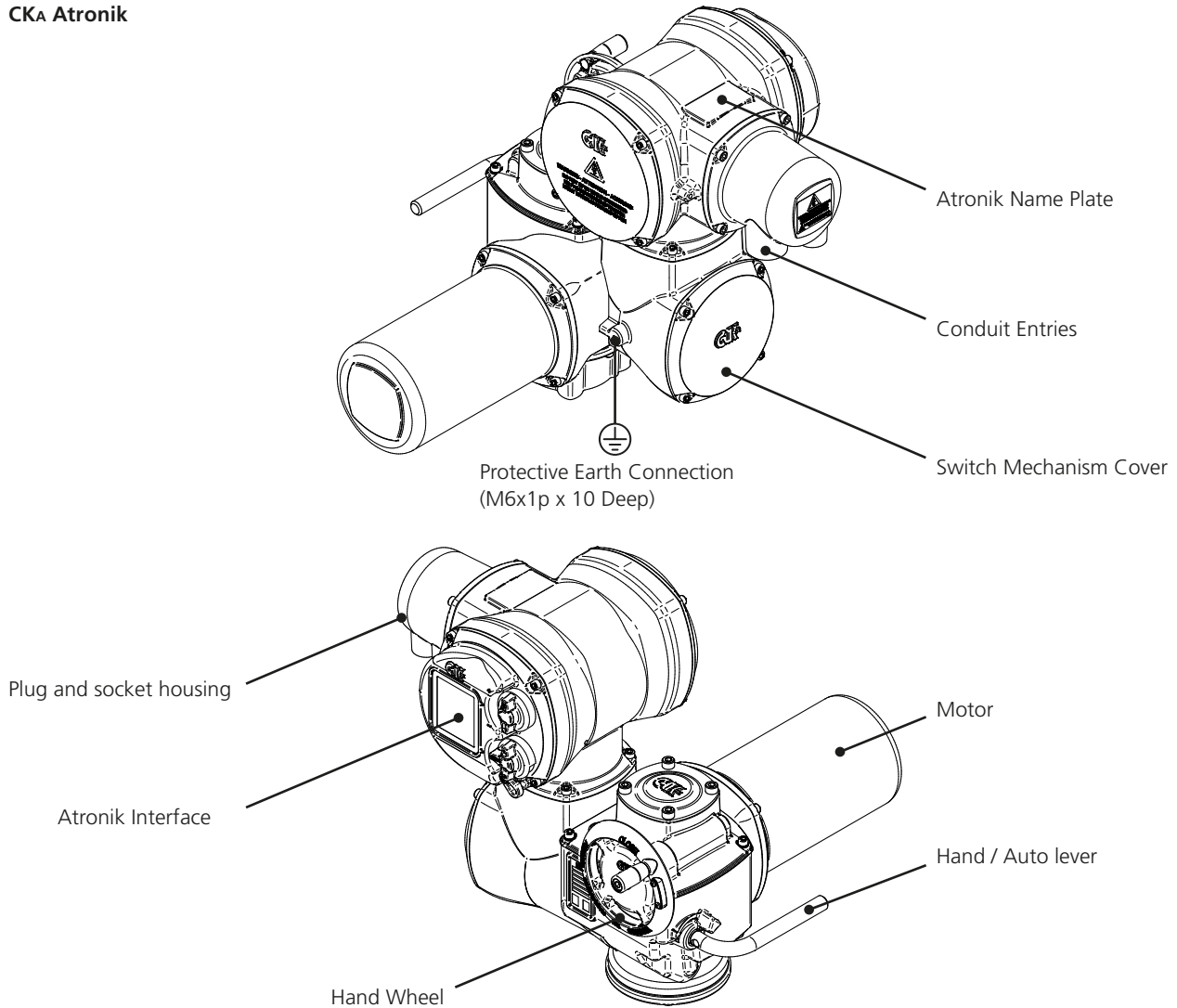

Atronik Module Nameplate

The Atronik name plate will enable you to identify your unit.
Example below:

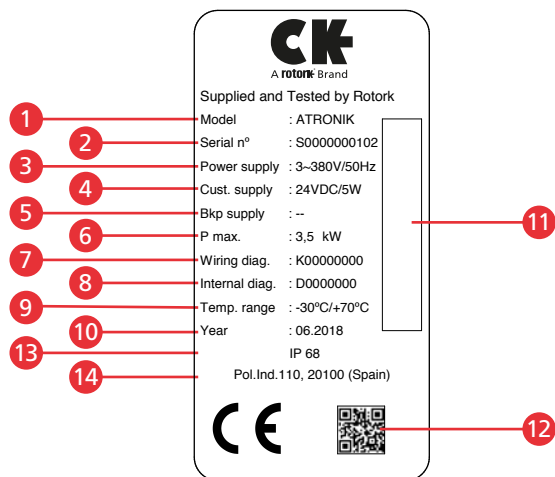

Mark	Description
1	Model
2	Serial Number
3	Power Supply
4	Customer Supply
5	Backup Supply
6	P max
7	Wiring Diagram
8	Internal Diagram
9	Temperature Range
10	Manufacturing Year
11	Serial No. Code Bar
12	QR Code
13	IP Degree
14	Address

3. Commissioning

3.1 Mechanical Switch Mechanism

Test Feedback Switches

- 1) Confirm the torque or limit switches are functional by monitoring feedback on the Atronik status indicators during switch testing.

⚠ The main power supply must be maintained during this test procedure to ensure feedback via the Atronik.

It is not possible to test a switch that is already actuated by the mechanism (for instance, at the end of travel limits). To ensure that all switches can be tested correctly, move the actuator to a mid-travel position and confirm that none of the switches are active before beginning the test procedure.

- 2) Test position switches in both directions using a flat screw-driver to turn LS TEST. Clockwise (CW) for open and anti-clockwise (ACW) for close.

The applicable status indicator will illuminate when the switch is active. Verify that mid-travel is illuminated prior to testing the switch status.

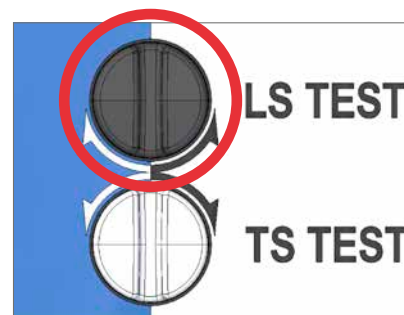
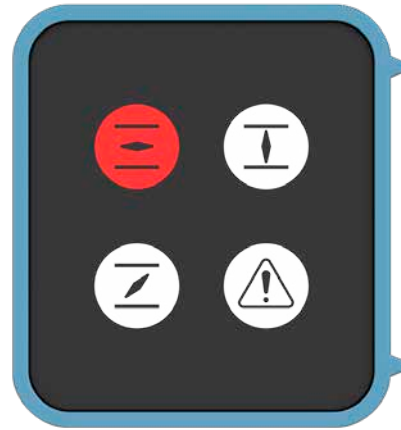

Test Feedback Switches

- 3) Test torque switches in both directions using a flat screwdriver to turn TS TEST (ACW for open, CW for close).

Torque switch status is shown via the fault indicator. Fault should illuminate when the torque switch is engaged in either direction.

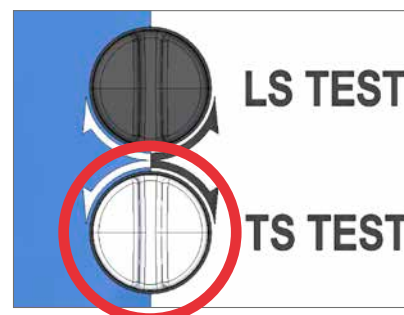

3. Commissioning

A 5 mm Allen (Hex.) key and 0.8 x 4 mm flat screwdriver are required to perform commissioning of the CK Mechanical Switch Mechanism.

Set torque limits

A Indicator/Adjustment Point

B Torque Cam Clutch Screw

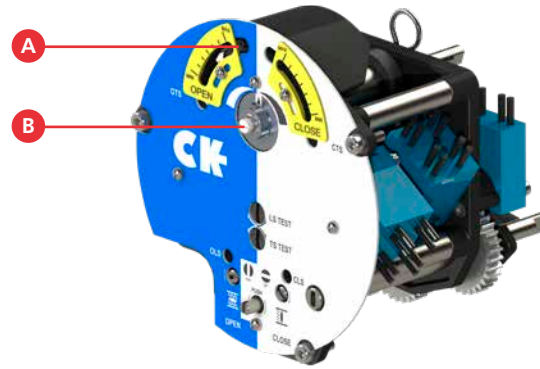

- 1) Move the valve to a mid-travel position and loosen the Torque Cam Clutch 1.5 turns using a flat screwdriver.

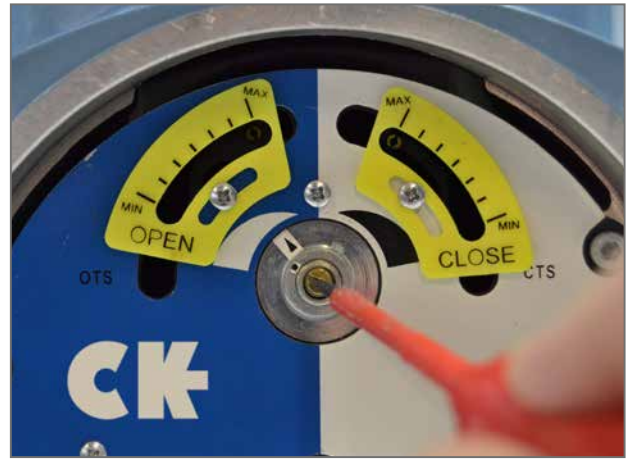

- 2) Adjust each Torque Cam to the desired value (between min. & max.) by moving the cam using a screwdriver on the adjustment point.

⚠ CAUTION: Ensure the screwdriver remains perpendicular to the switch mechanism faceplate when adjusting the torque trip limits to avoid introducing an offset to the set value.

C Open Torque Adjustment Point

D Close Torque Adjustment Point

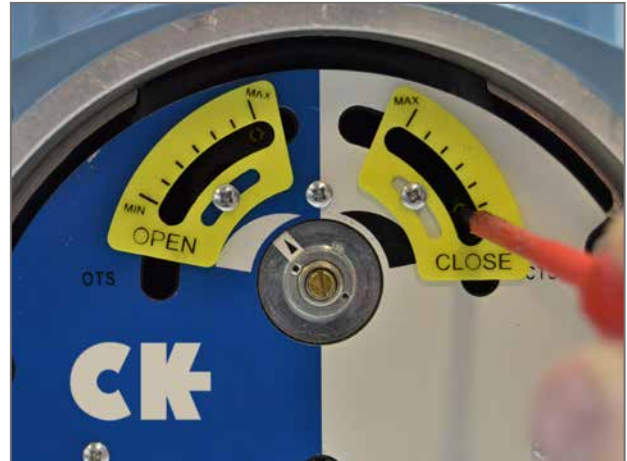

- 3) Tighten the Torque Cam Clutch Screw once both torque trip limits have been set.

⚠ CAUTION: Ensure the Torque Cam Clutch Screw is tightened enough to fully deform the spring washer underneath the screw head.

E Factory Calibration Fixings

⚠ WARNING: Do not adjust the fixings or position of the yellow torque indicator plates. These are factory configured for 40-100% adjustment of the actuator torque and under no circumstances should be moved.

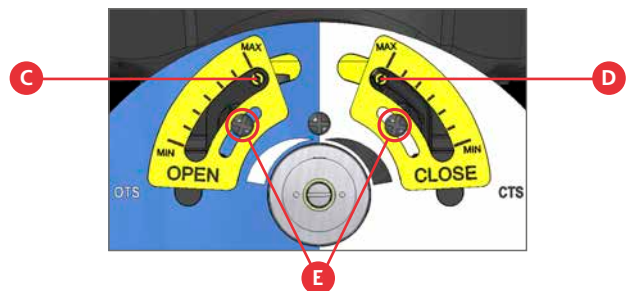

3. Commissioning

Set Position Limits

- F OLS Indicator Window
- G OLS Adjustment Screw
- H Drive Clutch Shaft
- I CLS Indicator Window
- J CLS Adjustment Screw

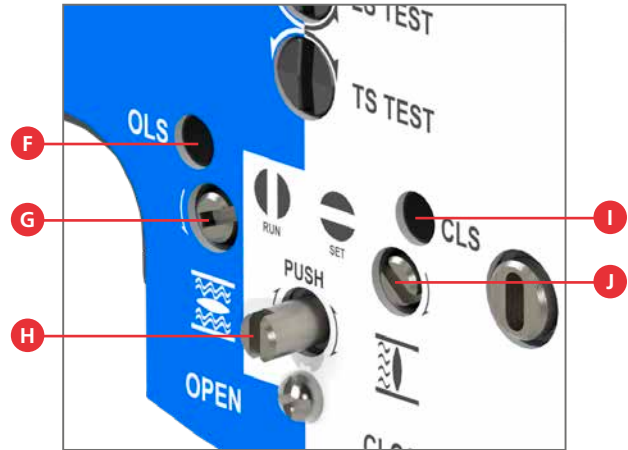

- 1) Move actuator to the valve CLOSED position using handwheel operation.
- 2) Using a flat screwdriver, depress the Drive Clutch Shaft and rotate to "SET" position as shown on the switch mechanism faceplate.
- 3) The CLS Adjustment Screw must now be rotated to make the closed limit switch inside the switch mechanism. The CLS Indicator Window will show one of four possible symbols. Please refer to Figure 1 on page 7 for direction input.
- 4) Depending on where the mechanism is in the cycle, it is possible that the switch will be approached from the wrong direction, in which case it is necessary to move through the limit and approach it from the correct direction. This is done to avoid the need to wind through the whole mechanism to reach the limit position. The correct direction to approach the limit is shown by the arrow next to the Adjustment Screw input.
- 5) Perform two checks to confirm the CLOSED limit position switch has been made correctly.
 - a. The feel of the Adjustment Screw will noticeably change providing more mechanical resistance at the switching point of the contact.
 - b. Confirm the switch has been made by checking the CLOSED limit indicator is illuminated on the Atronik.
- 6) Using a flat screwdriver, depress the Drive Clutch Shaft and rotate to "RUN" position as shown on the switch mechanism faceplate.
- 7) Rotate the CLS and OLS Adjustment Screws a small amount in both directions to re-engage the mechanism drive. A click will be heard as the drive drops back into engagement and the adjustment screws will no longer move in either direction.

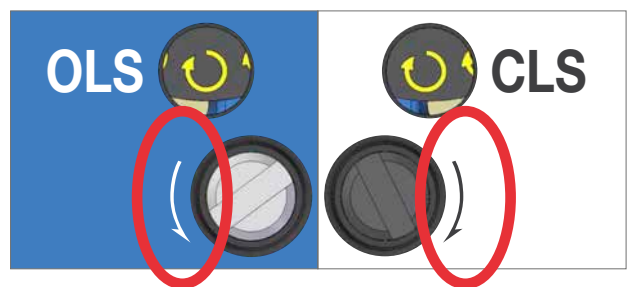

⚠ Step 7 must be done or the limit will be lost when the actuator is moved.

3. Commissioning

- 8) Move actuator to the valve OPEN position using handwheel operation.
- 9) Using a flat screwdriver, depress the Drive Clutch Shaft and rotate to "SET" position as shown on the switch mechanism faceplate.
- 10) The OLS Adjustment Screw must now be rotated to make the open limit switch inside the switch mechanism. The OLS Indicator Window will show one of four possible symbols. Please refer to Figure 1 below for direction input.
- 11) Depending on where the mechanism is in the cycle, it is possible that the switch will be approached from the wrong direction, in which case it is necessary to move through the limit and approach it from the correct direction. This is done to avoid the need to wind through the whole mechanism to reach the limit position. The correct direction to approach the limit is shown by the arrow next to the Adjustment Screw input.
- 12) Perform two checks to confirm the OPEN limit position switch has been made correctly.
 - a. The feel of the Adjustment Screw will noticeably change providing more mechanical resistance at the switching point of the contact.
 - b. Confirm the switch has been made by checking the OPEN limit indicator is illuminated on the Atronik.
- 13) Using a flat screwdriver, depress the Drive Clutch Shaft and rotate to "RUN" position as shown on the switch mechanism faceplate.
- 14) Rotate the OLS and CLS Adjustment Screws a small amount in both directions to re-engage the mechanism drive. A click will be heard as the drive drops back into engagement and the adjustment screws will no longer move in either direction.

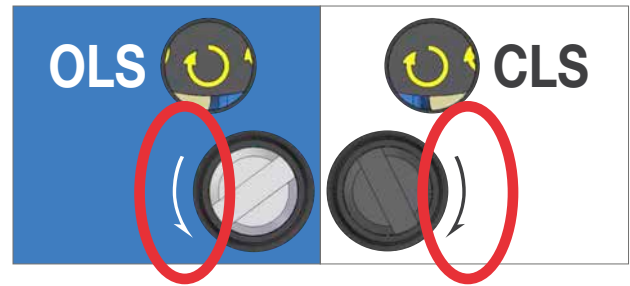

⚠ Step 14 must be done or the limit will be lost when the actuator is moved.

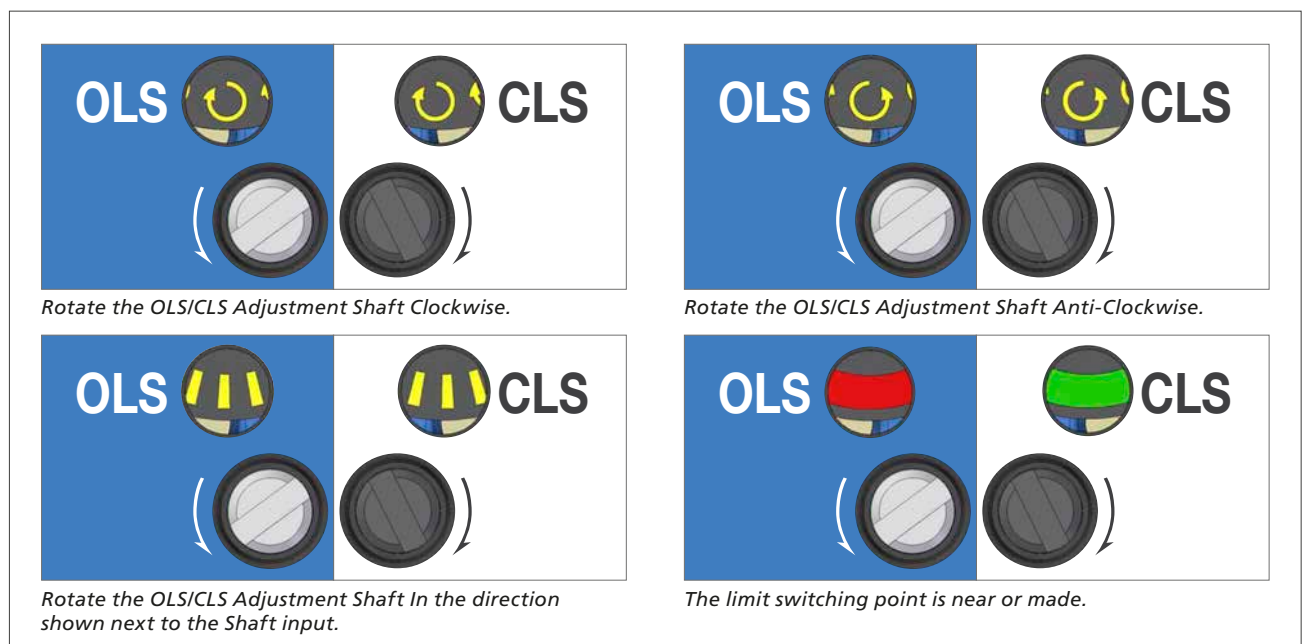

Figure 1.

3. Commissioning

3.2 Additional Indication Drive

The Additional Indication Drive (AID) supplements the mechanical switch mechanism to increase functionality.

Test Feedback Switches

- 1) Confirm the torque or limit switches are functional by monitoring feedback on the Atronik status indicators during switch testing.

⚠ The main power supply must be maintained during this test procedure to ensure feedback via the Atronik.

It is not possible to test a switch that is already actuated by the mechanism (for instance, at the end of travel limits). To ensure that all switches can be tested correctly, move the actuator to a mid-travel position and confirm that none of the switches are active before beginning the test procedure.

- 2) Test position switches in both directions using the LS TEST lever shown on the right side of the unit between the AID module and Mechanical Switch Mechanism (move DOWN for open, UP for close).

The applicable status indicator will illuminate when the switch is active. Verify that mid-travel is illuminated prior to testing the switch status.

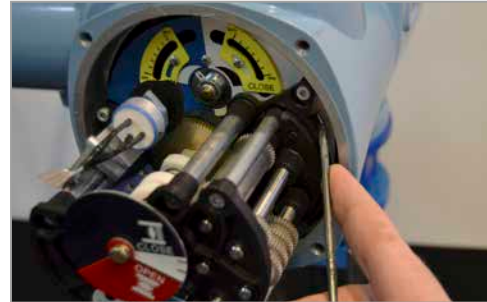

Test Feedback Switches

- 3) Test torque switches in both directions using the TS TEST lever shown on the left side of the unit between the AID module and Mechanical Switch Mechanism (move DOWN for open, UP for close).

Torque switch status is shown via the fault indicator. Fault should illuminate when the torque switch is engaged in either direction.

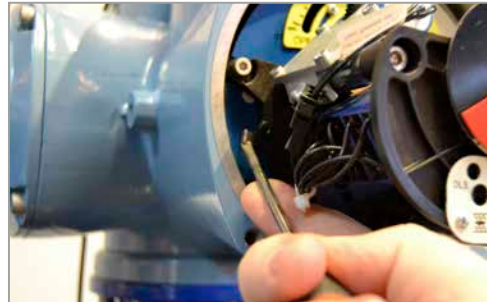

3. Commissioning

Setting Local Position Disc

The AID module includes a Local Position Disc that should be configured to show Open and Close limit positions. A series of reduction gears ensure a suitable range of travel can be accommodated. If more turns are required please contact Rotork.

⚠ CAUTION: The actuator position limits must be configured prior to setting the Local Position Disc.

⚠ CAUTION: The AID cover orientation can be adjusted through 360° in 90° increments. If this is a requirement then the following instructions must be adjusted by the same increment in the same direction.

- 1) Move the actuator to the CLOSED limit using electrical operation or the handwheel.
- 2) Loosen off the Position Disc Retaining Screw by 1 turn.
- 3) Rotate the Position Disc so that CLOSE reads horizontally and hold the disc in place.
- 4) Tighten the Position Disc Retaining Screw until the Position Disc is firmly locked in place.
- 5) Confirm the CLOSE label is aligned correctly with the cover indication arrow.

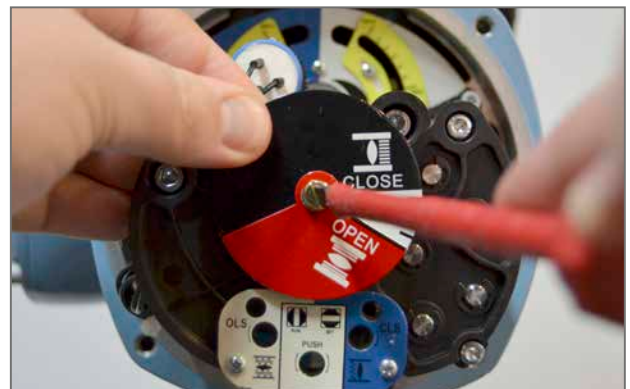
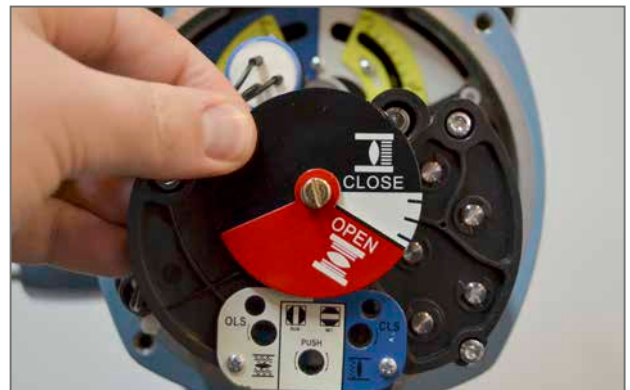
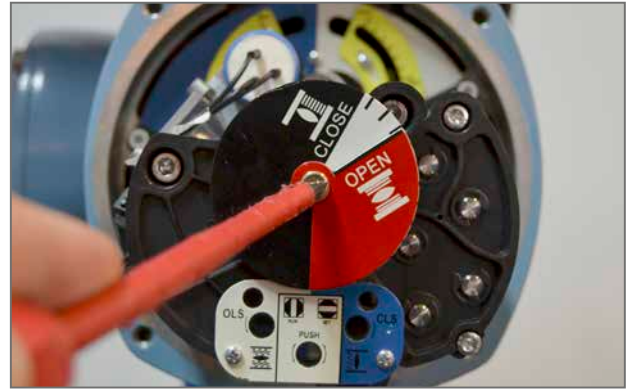

3. Commissioning

- 6) Move the actuator to the OPEN limit using electrical or operation or the handwheel.

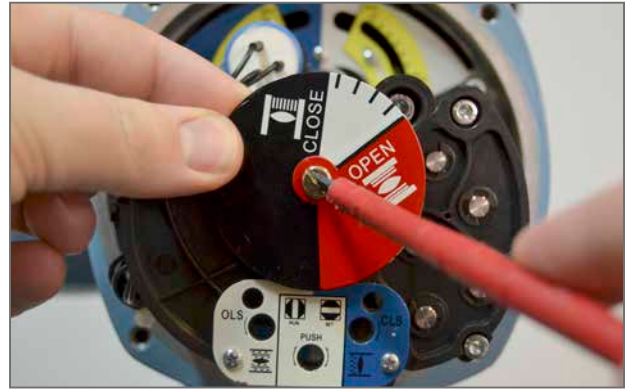

- 7) Loosen off the Position Disc Retaining Screw by 1 turn whilst holding the CLOSE portion of the Position Disc.
- 8) Rotate only the red OPEN portion of the disc so that OPEN reads horizontally and then hold both portions in place.



- 9) Tighten the retaining screw until the Position Disc is firmly locked in place.

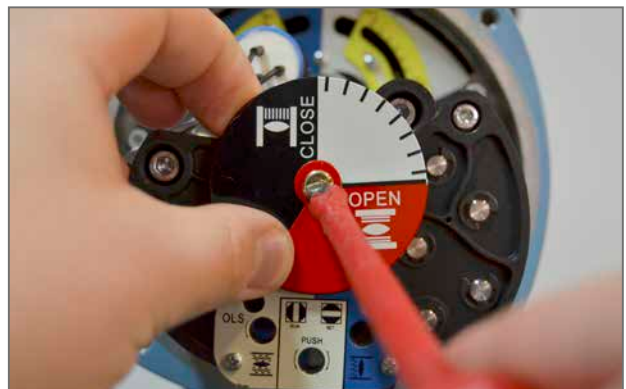

- 10) Confirm the OPEN label is aligned correctly with the cover indication arrow.



3. Commissioning

Setting Intermediate Switches

The AID Module can include four additional switches to indicate configurable intermediate positions.

⚠ CAUTION: The actuator position limits must be configured prior to setting the Intermediate Switches.

- 1) Move the actuator to the desired intermediate position using electrical operation or the handwheel.
- 2) Move the switch cam along the shaft against the spring to allow free rotation of the cam.
- 3) Rotate the cam to ensure the desired switch behaviour is achieved. The intermediate position switches can be supplied with normally open or normally closed contact form.
- 4) Confirm the switch has been engaged/disengaged by measuring continuity across the relevant terminals during cam adjustment – refer to actuator wiring diagram and pictorial annotations (right) for the relevant switch information.
- 5) Repeat steps 1 to 4 for each intermediate position switch.

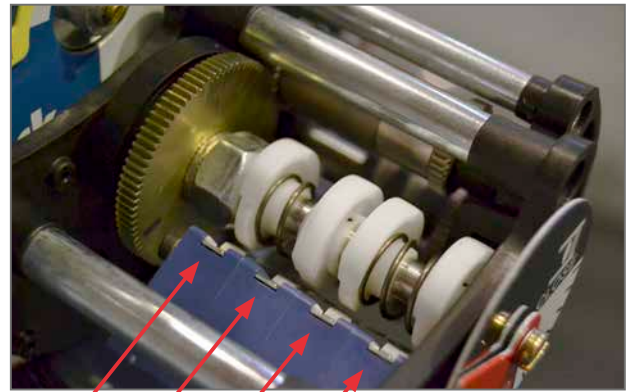

IP4 IP3 IP2 IP1



3. Commissioning

Setting the POT

The AID Module can include a potentiometer (POT) to report intermediate position to the Atronik control module. Alternatively, the POT can provide a direct potentiometric output or drive the AID CPT option (refer to next page).

The POT drive includes four different sized gears that allow the single turn POT to be scaled according to the total valve travel. For information on which ratio is suitable for your application please contact Rotork.

If the POT is connected to the Atronik, fine adjustment of the POT travel is not required.

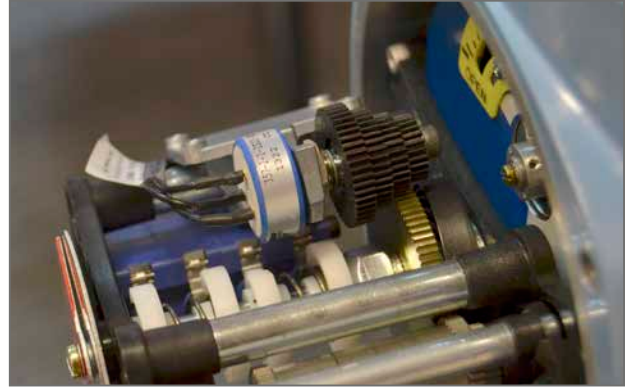

⚠ CAUTION: The actuator position limits must be configured prior to setting the AID POT drive.

- 1) Loosen off the retaining grub screw using a 1.5 mm Allen (Hex.) Key.
- 2) Rotate the POT drive assembly away from the driving gear.
- 3) Move the actuator to the Closed Limit position using electrical operation or the handwheel.
- 4) If the POT signal is not wired to the Atronik, connect a test meter to the POT terminals* – refer to actuator wiring diagram and POT Setting Information table below.
- 5) Rotate the POT input gears anti-clockwise until the POT cannot rotate any further. Confirm the POT is triggering the Close Limit indicator on the Atronik or reading the required resistance value.
- 6) Refit the POT assembly to the AID chassis and ensure the teeth mate correctly with the position drive gear.

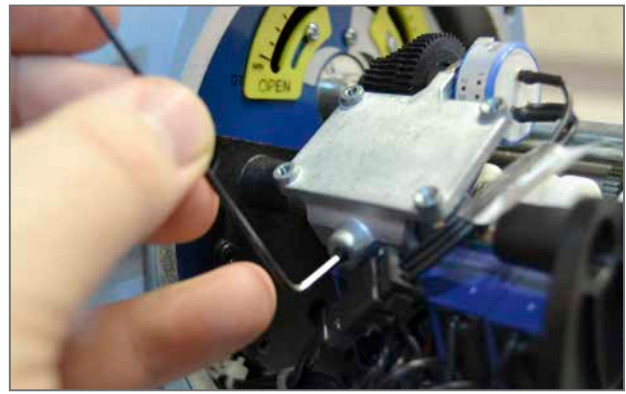

⚠ CAUTION: Extra care must be taken to ensure the correct POT input gear is mated with the position drive gear.

- 7) Tighten the retaining grub screw to prevent movement of the POT drive assembly.
- 8) Move the actuator to the Open Limit position using electrical operation or the handwheel.
- 9) Monitor POT rotation throughout valve travel and ensure the maximum POT travel is not exceeded. A different gear selection may be necessary if POT travel is exceeded.
- 10) Confirm the POT is triggering the Open Limit indicator on the Atronik or reading the required resistance value.

*Potentiometer terminals may not be accessible if the AID CPT option is also fitted. In this instance it is important to ensure the POT does not slip throughout full valve travel. Calibration of the 4 – 20mA CPT output is detailed on the next page.

POT Setting Information			
Travel Direction	Value at Closed Limit	Value at Open Limit	Measurement Terminals
Clockwise	Low	High	30 & 31
Clockwise	High	Low	31 & 32
Anti-Clockwise	Low	High	31 & 32
Anti-Clockwise	High	Low	30 & 31

3. Commissioning

Setting the CPT

Once the POT drive is commissioned for full valve travel, the CPT can be calibrated to output a 4-20 mA loop powered signal. This can be used as direct actuator position feedback to the site control system.

The CPT option includes two different trimming potentiometers to enable zero and span values to be calibrated.

⚠ CAUTION: The actuator position limits and POT drive must be configured prior to setting the AID CPT.

- 1) Run the actuator to the Closed position limit using electrical operation or the handwheel.
- 2) Connect a powered test meter across the CPT terminals and measure the transmitted current – refer to actuator wiring diagram.
- 3) Rotate the ZERO trimming potentiometer so that 4 mA is output from the CPT.
- 4) Run the actuator to the Open position limit using electrical operation or the handwheel.
- 5) Rotate the SPAN trimming potentiometer so that 20 mA is output from the CPT.
- 6) Adjustment of the SPAN will cause the ZERO to change a small amount. It is important to repeat steps 1 to 5 a second time in order to remove this calibration error.

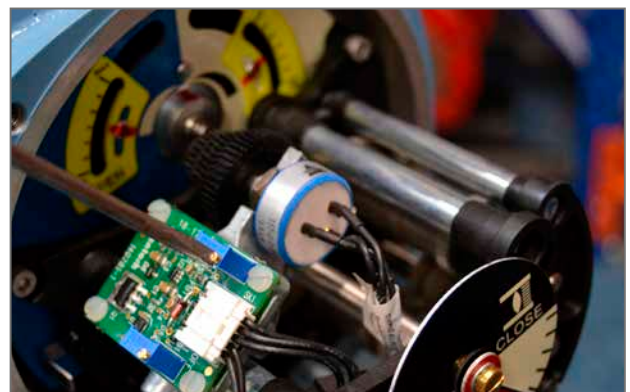
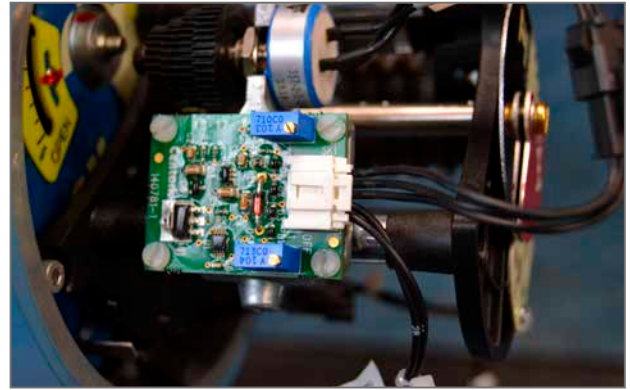

4. CK Atronik

4.1 Standard Settings

Configuration of the Atronik control module is performed via DIP switches located on the user interface PCB within the Atronik enclosure.

DIP switch functions

Label	Function	OFF	ON
ESD FUNCTION A	ESD Action	A OFF and B OFF = Disabled A ON and B OFF = Open	A ON and B ON = Stay put A OFF and B ON = Close
ESD FUNCTION B			
ESD NC/NO	ESD Contact Form	ESD active when signal applied (normally open)	ESD active when signal removed (normally closed)
PTR LOCAL	Local Control	Local control is push-to-run	Local control is maintained
CLOSE DIRECTION	Direction	Clockwise to close	Anti-clockwise to close
PRIORITY A	2-Wire Priority	A OFF and B OFF = Close Priority A ON and B OFF = No Priority	A ON and B ON = Open Priority A OFF and B ON = No Priority
PRIORITY B			
OPEN ACTION	Open Action	Stop on position limit	Stop on torque limit
CLOSE ACTION	Close Action	Stop on position limit	Stop on torque limit
LED	LED	Green = Close Red = Open	Red = Close Green = Open
STD/OPT CONTROL	Control Source	Hardwired control only	Option control only
POWER	Power	3-phase power supply	1-phase power supply
RELAY A	Relay Conditions	Relay settings are determined by a combination of A, B and C. Refer to below table for details.	
RELAY B			
RELAY C			
SETUP	Actuator speed*	Actuator speed > 12 RPM	Actuator speed ≤ 12 RPM

*SETUP switch does not alter actuator output speed.

Standard Relay Conditions

RELAY A	RELAY B	RELAY C	Relay 1 Function	Relay 2 Function
OFF	OFF	OFF	Close Limit	Open Limit
OFF	OFF	ON	Torque Trip	Motor Stall
OFF	ON	OFF	Motor Stall	Thermostat Trip
OFF	ON	ON	Torque Trip Close	Torque Trip Open
ON	OFF	OFF	Mid Travel	Torque Trip
ON	OFF	ON	Remote Selected	ESD Active
ON	ON	OFF	Local Selected	Stop Selected
ON	ON	ON	Blinker	Hand Operation

4. CK Atronik

4.2 Option Settings

Extra Relays

Atronik can accommodate four additional relay contacts with configurable functions. These are determined by DIP switches located on the extra relay PCB.

Switch 1	Switch 2	Switch 3	Relay 3 Function	Relay 4 Function
OFF	OFF	OFF	Open Limit	Closed Limit
OFF	OFF	ON	Torque Trip Open	Torque Trip Closed
OFF	ON	OFF	Blinker	Local Selected
OFF	ON	ON	Motor Stall	ESD Active
ON	OFF	OFF	Torque Trip	ESD Active
ON	OFF	ON	Hand Operation	ESD Active
ON	ON	OFF	Local Selected	Mid Travel
ON	ON	ON	Valve Alarm	24 VDC Power Fail

Switch 4	Switch 5	Switch 6	Relay 5 Function	Relay 6 Function
OFF	OFF	OFF	Closed Limit	Open Limit
OFF	OFF	ON	Torque Trip Closed	Torque Trip Open
OFF	ON	OFF	Mid Travel	Local Selected
OFF	ON	ON	Actuator Alarm	Hand Operation
ON	OFF	OFF	Stop Selected	Hand Operation
ON	OFF	ON	Remote Selected	Motor Running
ON	ON	OFF	Local Selected	Motor Running
ON	ON	ON	Mid Travel	Motor Running

Positioner

The positioner option for Atronik enables control of actuator position with a proportional analogue signal. Feedback is transmitted via 4-20 mA to provide remote intermediate position indication.

Switch	No	Function	OFF	ON
SW5	6	Positioner Inverse	Control signal is: Close = low, Open = high	Control signal is: Close = high, Open = low
	5	CPT Inverse	Feedback signal is: Close = 4 mA, Open = 20 mA	Feedback signal is: Close = 20 mA, Open = 4 mA
	4	Signal Loss Action	SW5-3 OFF and SW5-4 OFF = Close	SW5-3 ON and SW5-4 ON = Open
	3		SW5-3 ON and SW5-4 OFF = OFF	SW5-3 OFF and SW5-4 ON = Stayput
	2	Input Type	SW5-1 OFF and SW5-2 OFF = 0-20 mA	SW5-1 ON and SW5-2 ON = 0-20 V
1	SW5-1 ON and SW5-2 OFF = 0-5 V		SW5-1 OFF and SW5-2 ON = 0-10 V	
SW4	0 – 9	Deadband	10* position switch with incrementing values: 0.5%, 1%, 2%, 3%, 5%, 10%	
SW3	0 – 9	Motion Inhibit Timer	10* position switch with incrementing values: 1s, 2s, 5s, 10s, 30s, 60s	
	SW1	Set Open	Inject signal for the Open position and hold SW1 for 3 seconds to set the value	
	SW2	Set Close	Inject signal for the Close position and hold SW2 for 3 seconds to set the value	

Deadband and MIT should be adjusted to provide suitable control accuracy while still filtering out unwanted signal fluctuations and noise.

* Position 0 is the lowest setting, incrementing by one for each subsequent setting value. Surplus positions will match the highest setting value and are reserved for future use.

rotork®



www.rotork.com

A full listing of our worldwide sales and service network is available on our website.

Rotork plc
Brassmill Lane, Bath, UK
tel +44 (0)1225 733200
email mail@rotork.com

PUB111-110-00
Issue 03/20

As part of a process of on-going product development, Rotork reserves the right to amend and change specifications without prior notice. Published data may be subject to change. For the very latest version release, visit our website at www.rotork.com

The name Rotork is a registered trademark. Rotork recognizes all registered trademarks. Published and produced in the UK by Rotork. POWTG0121