

rotork®

Keeping the World Flowing
for Future Generations

rotork® *Master Station*

Safe Use, Installation and Maintenance Manual



CE UK
CA



rotork® Master Station



Table of Contents

Section	Page
1. Introduction	4
2. Know your Rotork <i>Master Station</i>	6
3. Rotork <i>Master Station</i> Technical Datasheet	12
4. Health and Safety	14
5. Installation	15
6. Basic Commissioning	17
7. Environmental	26
8. Fuses	26
9. Vibration and Shock	26
10. EMC	26
11. Safety	27
12. Storage	27

 This information is needed to avoid a safety hazard, which might cause bodily injury.

 This information is necessary to prevent damage to the product or other equipment.

 This manual contains important safety information. Please ensure it is thoroughly read and understood before installing, operating or maintaining the equipment.

This manual is produced to enable a competent user to install, operate, adjust and inspect the Rotork *Master Station*.

These user instructions are provided subject to the following conditions and restrictions:

This document contains information of a proprietary nature belonging to Rotork. Such information is supplied solely for the purpose of assisting users of the Rotork *Master Station* in its installation, operation and maintenance.

The text and graphics included in this document are for the purpose of illustration and reference only. The specifications on which they are based are subject to change without notice.

Information in this document is subject to change without notice.

This work and the information it contains are the property of Rotork. The information it contains shall not be reproduced or disclosed, in whole or in part without the prior written consent of Rotork.

1. Introduction

The Rotork *Master Station* provides an intelligent interface between a host Modbus system and the connected Field Control Units (FCUs). It performs the functions of running the field network, data aggregator, data viewer and managing the host Modbus database.

The Modbus database presented to the host is independent of the field network protocol, giving a common open industry standard interface to the host for process control information.

The host Modbus connection is Ethernet (TCP) as standard, with the connections on the CPU module itself. For applications that require a serial host connection a Host Serial Add In Module (AIM) is required to provide the serial connection.

In addition to the Modbus host database, the *Master Station* has a local display where the user can interrogate configuration, status and alarm data from FCUs or the *Master Station*. For remote access, the *Master Station* has built-in web pages mirroring the local display.

There are two different field networks available as AIMs for the *Master Station* and up to four AIMs can be fitted to the *Master Station*. The field network AIMs run the individual field networks, distributing commands and collecting data from the FCUs to populate the host database. Two different field network AIMs (Modbus and *Pakscan Classic*) are available and one serial host RTU AIM is available.

- ***Pakscan Classic* field network AIM**

The *Pakscan Classic* redundant loop network has been the network of choice for actuator control for over 30 years. Using robust current loop technology, 20 km loop lengths and 240 FCUs are possible.

- **Modbus Open field network AIM**

Open Modbus field network with standard highway or redundant loop options. Other manufacturers' devices integrated into network by use of a field device description file.

- **Host Serial AIM**

Open Modbus serial connection for host controllers.

The Rotork *Master Station* can be supplied in three different configurations:

Single: A single sided *Master Station* comprising one display, one PSU module, one CPU module and up to four AIMs.

Dual: A dual sided *Master Station* comprising two displays, two PSU modules, two CPU modules and up to eight AIMs total. Each side can have different hardware configurations and remains separate from the other side.

Hot Standby: A dual sided *Master Station* comprising the same options as a single sided *Master Station* with a complete duplicate of modules for the second side. This enables switching between each side with no impact to network communications.



2. Know your Rotork Master Station

Hot Standby and Dual Rotork Master Station

Touch screen display

Hot Standby and Dual

Each side of a hot standby or dual Master Station has a display module to interface with that side of the Master Station.



Power LED
Green: power on,
off: power off

Status LED

Flashing Green: power up sequence.
Solid Green: indicates all applications are running correctly after a power up.
Red: Ethernet host communications lost or communication error between Master Station and a FCU.

Alarm LED

Green: no alarms are present on the system.
Red: any alarm condition in any FCU or the Master Station. This alarm does not prevent operation of the Master Station.

Primary button

Hot Standby

In hot standby configuration, the primary button can be used to set that side of the Master Station as the controlling hardware. The active controlling side of the Master Station can easily be identified by an illuminated button. The non-controlling side will not be illuminated.

Single and Dual

In single and dual Master Station configuration, the primary button has no function, but the backlight will remain illuminated to show the units are actively controlling.

Single Rotork Master Station



Single

A single Master Station has one display module for the left side. The right side is blanked off.

2. Know your Rotork Master Station *continued*

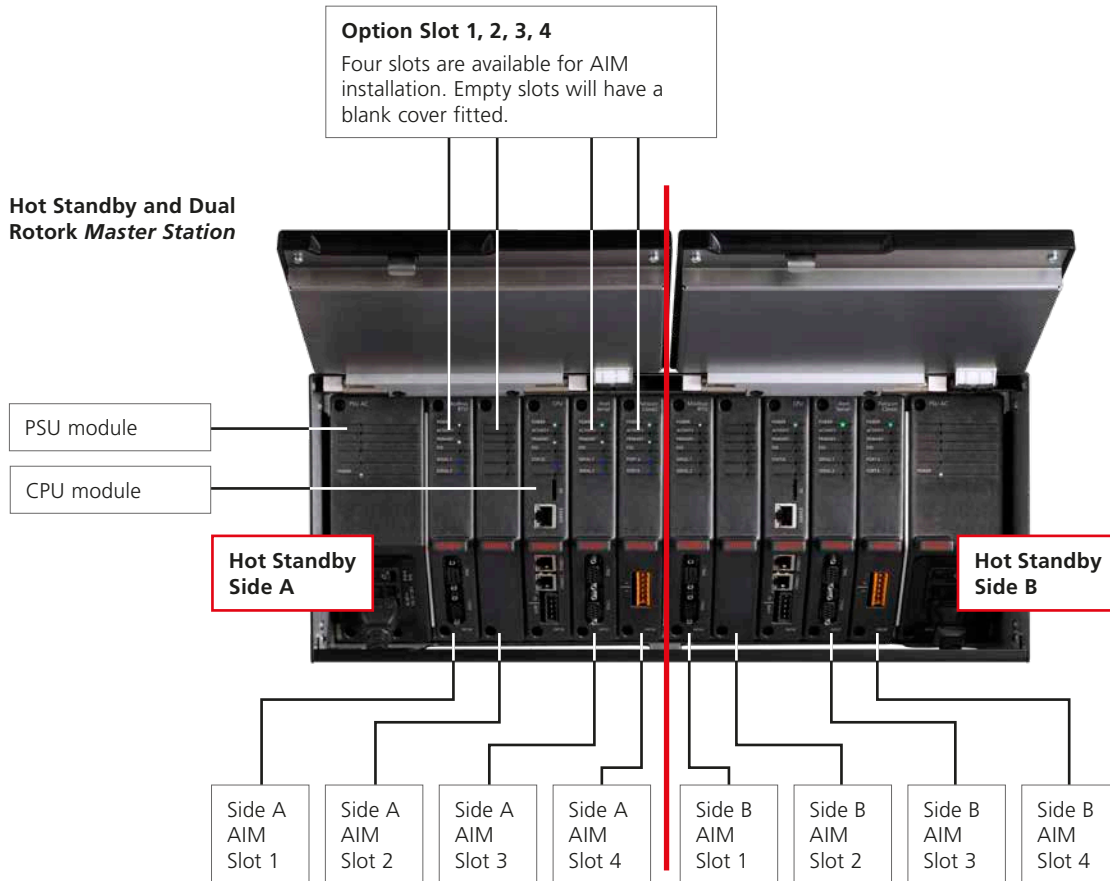

Hot Standby

The hot standby *Master Station* contains a duplicate set of modules on the right hand side. The position of AIMs fitted on the right must match the modules fitted on the left.

Dual

The dual *Master Station* has two separate sides that can accommodate different modules. A dual *Master Station* operates as two single *Master Stations*.

Single

The single *Master Station* has one set of modules installed on the left side of the *Master Station* chassis.

Single Rotork Master Station

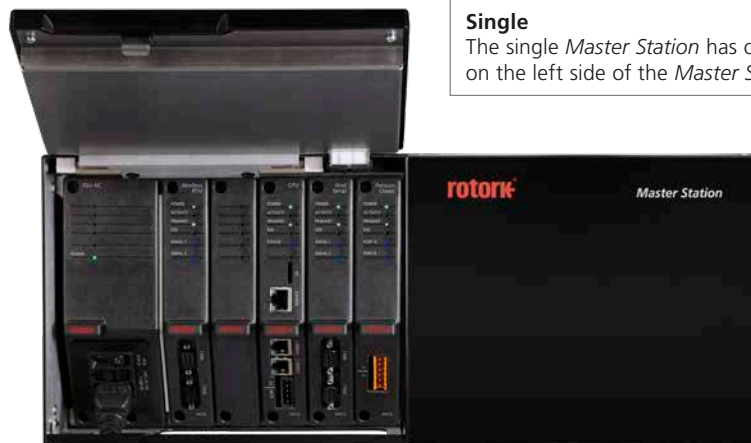

2. Know your Rotork Master Station *continued*

Example build details

The example below has three optional AIMs fitted; *Pakscan* Classic field network, Modbus RTU field network and Host Serial. Refer to the model code of your unit for confirmation of the AIMs fitted to your unit.

User connections

Master Station provides front access for all the user connections, including power, and field network connections to the *Pakscan* Classic module (P4720) or Modbus RTU module (P4724).

- CPU alarm, CPU ESD and *Pakscan* Classic field wiring connections are via screw terminals on removable connectors. Connectors are supplied pre-installed on each applicable module.
- Modbus RTU field connections are via 9-way D type connectors on the bottom of the Modbus RTU module (P4724). Both sockets are female on the *Master Station*.
- Power wiring is connected using an IEC-C13 connector on the bottom of the PSU module (P4740). Two power connections are required for a dual or hot standby system.
- Ethernet host is connected using standard RJ45 connectors on the bottom of the CPU module (P4710). The top connector is intended for temporary connection to a service laptop computer and marked clearly as a service port.
- Optional Serial host via RS-232 or RS-485 is connected using 9-way D type connectors on the bottom of the Host Serial module (P4727). Both sockets are female on the *Master Station*.

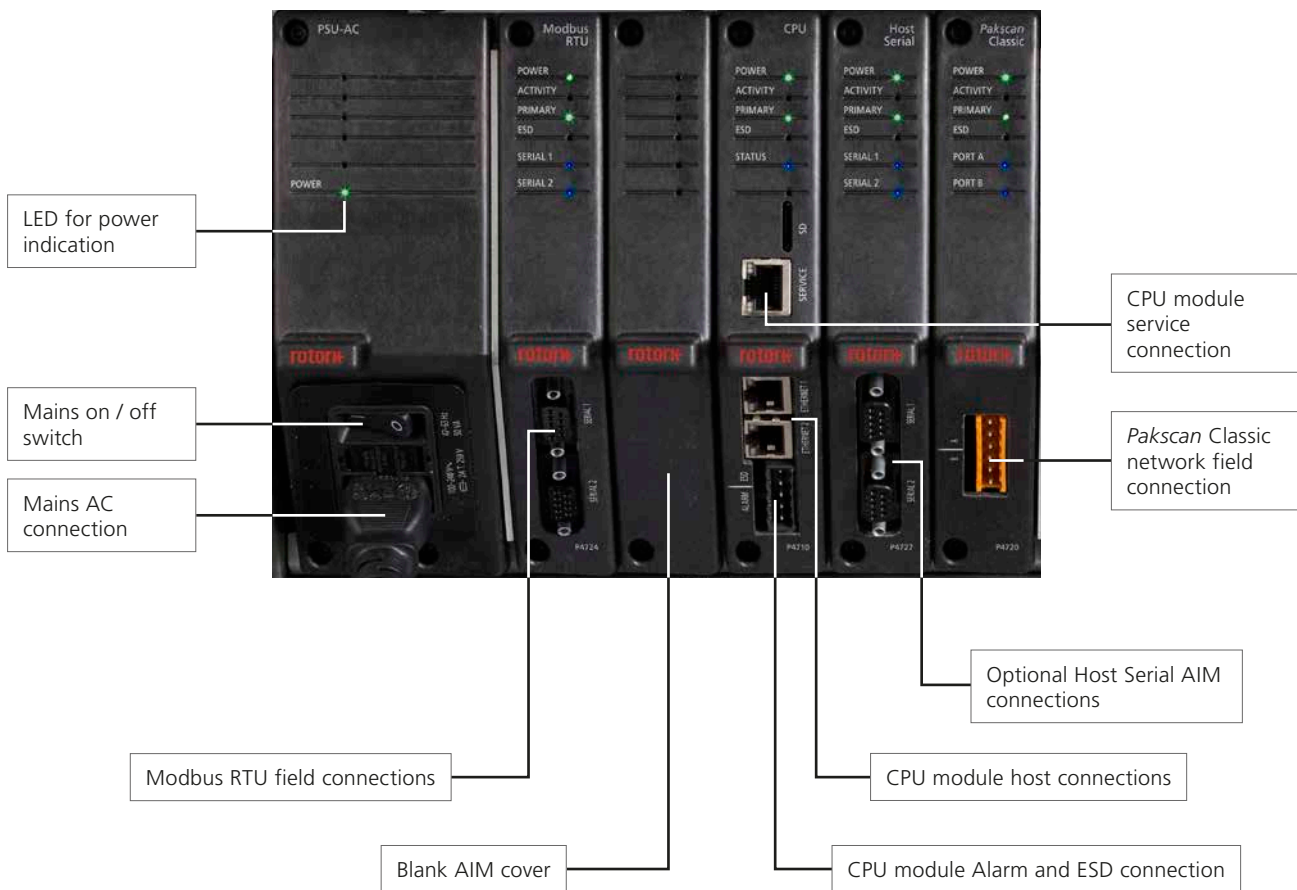

2. Know your Rotork Master Station *continued*

Single Rotork Master Station

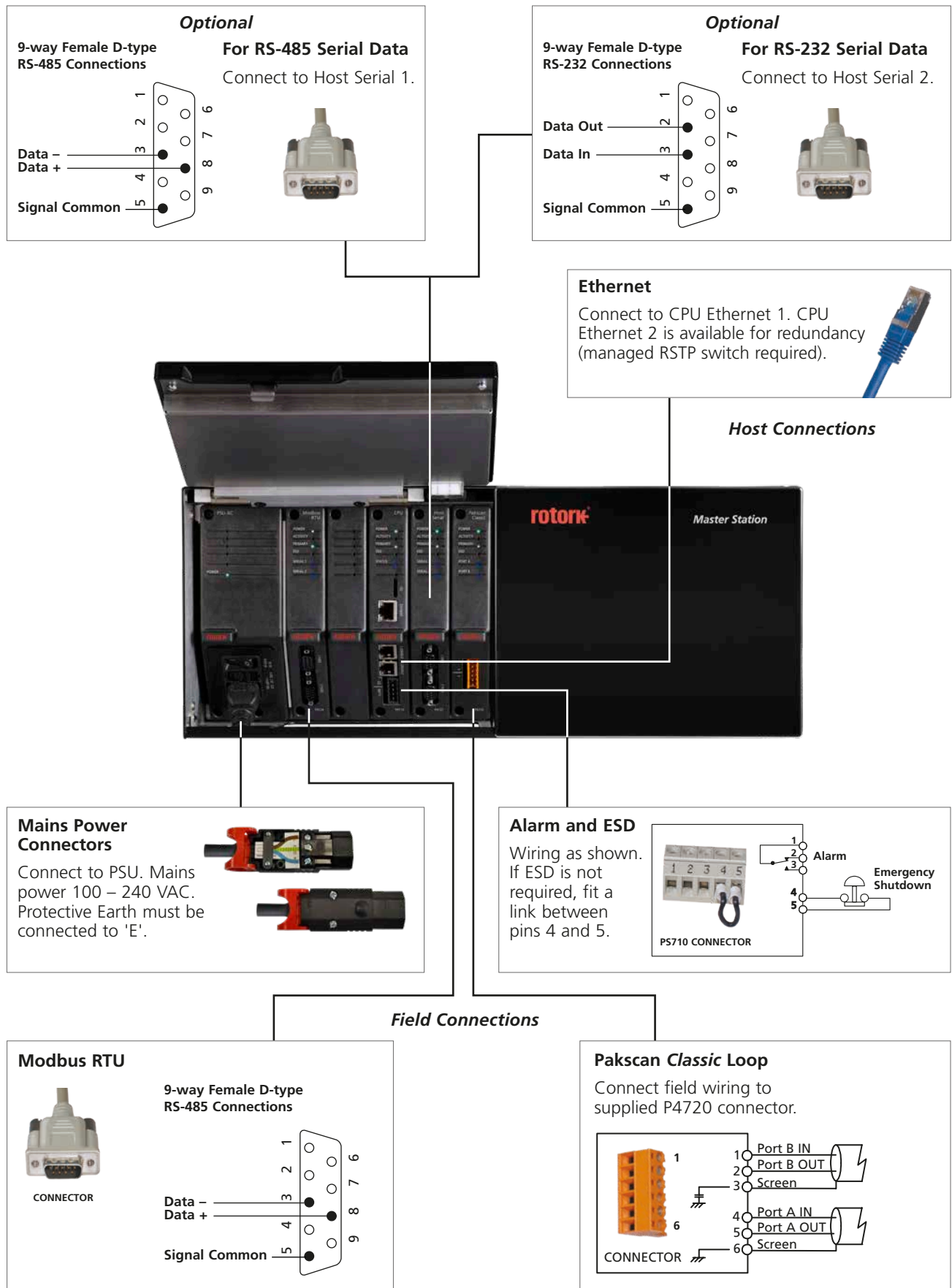

2. Know your Rotork Master Station *continued*

Hot Standby Rotork Master Station

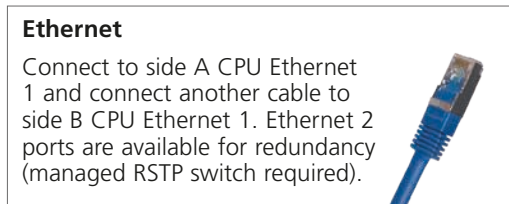
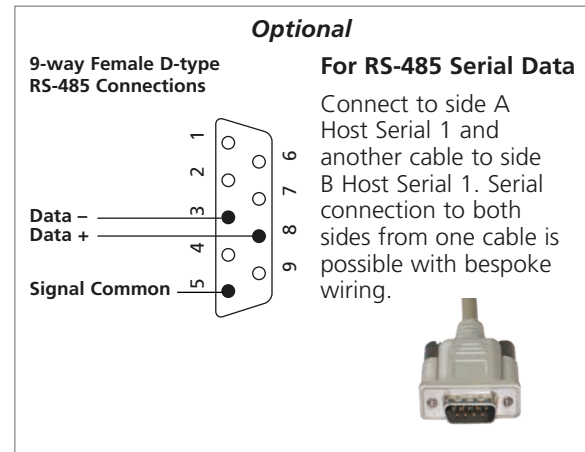
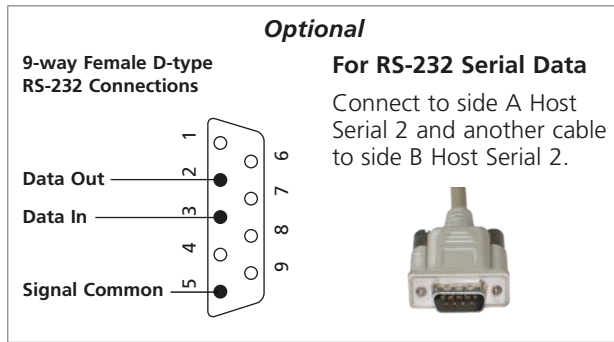

Host Connections

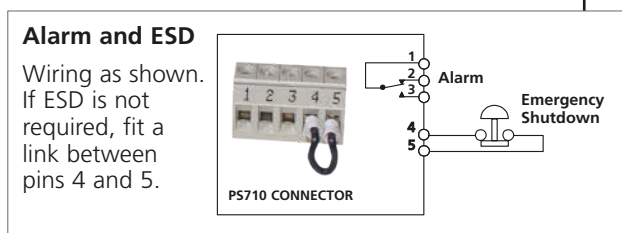

Field Connections

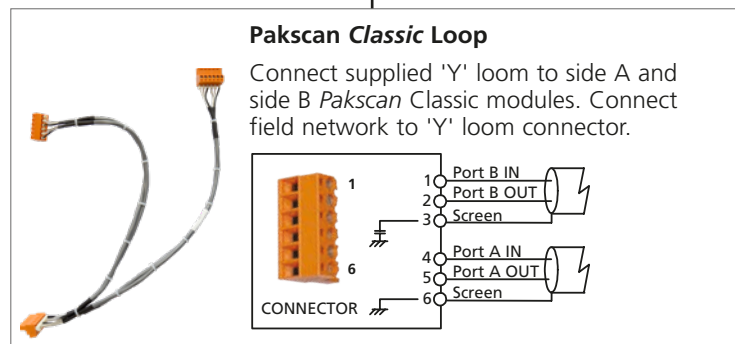
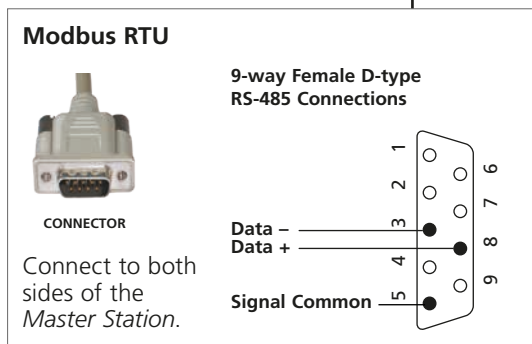

2. Know your Rotork Master Station *continued*

Dual Rotork Master Station

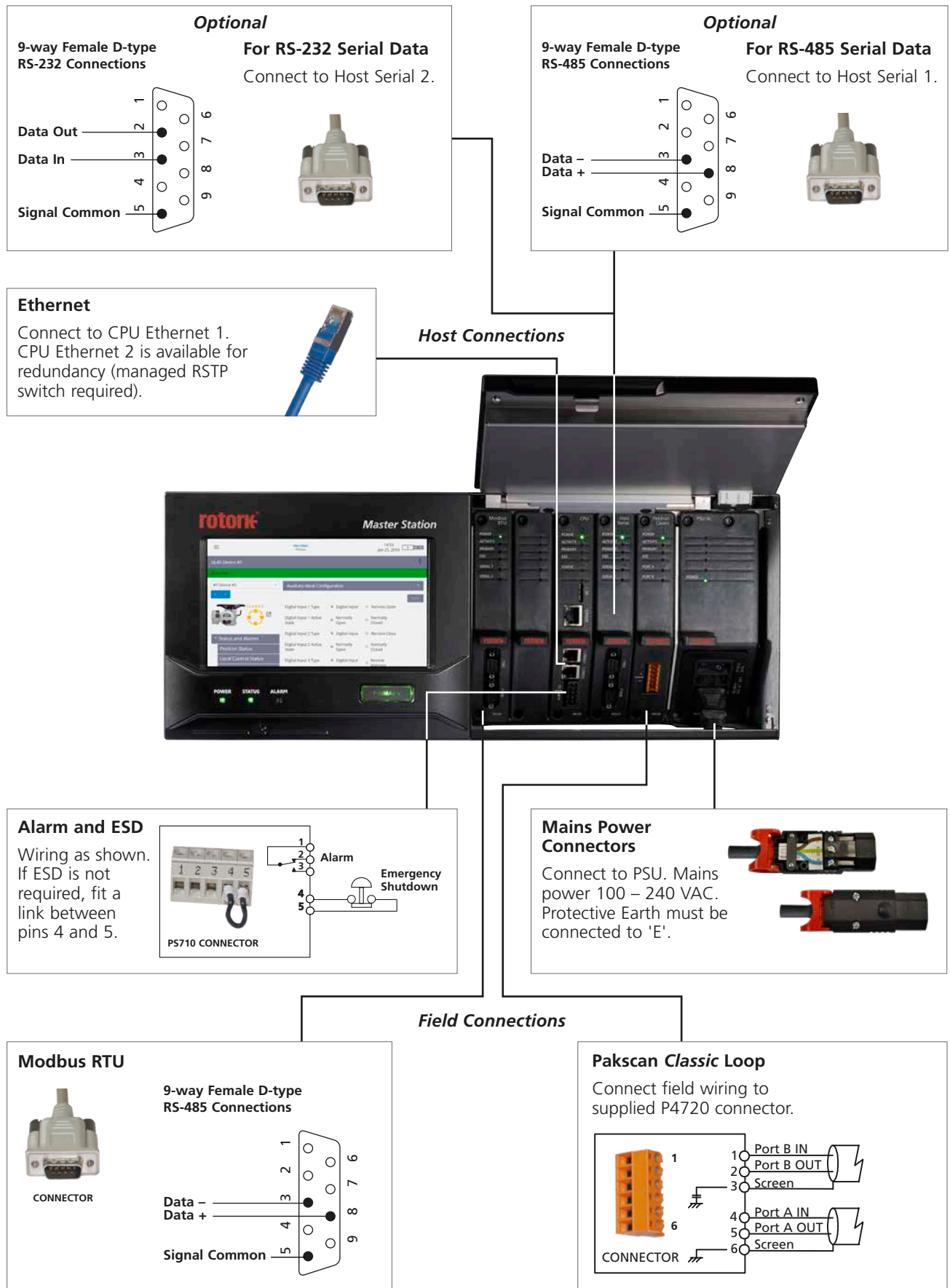

3. Rotork Master Station Technical Datasheet

Rotork Master Station Features	
Power supply, AC frequency and current consumption	<p>AC 100 – 240 V~ (±10%), 50 / 60 Hz (P4740)</p> <p>Power consumption: Max. 50 VA (single <i>Master Station</i>) Max. 100 VA (hot standby and dual <i>Master Stations</i>) Power supply type must be specified at time of order.</p>
Power connection	<p>Standard: AC, IEC-C13 Connector (Schurter v-lock compatible) Located at the front of the <i>Master Station</i>, behind the display, one on either side for hot standby and dual <i>Master Stations</i>.</p>
Housing	<p>Standard: 19" rack mount and panel mount fixings Box dimensions (without fixings): width 440 mm, height 177 mm (4U), depth 237 mm Single <i>Master Station</i> with 7" touch screen interface</p> <p>Option: Dual <i>Master Station</i>, second independent <i>Master Station</i> in same housing (2 displays). Hot standby, second redundant standby <i>Master Station</i> in same housing, linked to primary <i>Master Station</i> (2 displays).</p>
Communication between Master Station and FCUs	<p>Standard: There is no standard communication module. The field network must be specified at time of order.</p> <p>Option: The <i>Master Station</i> has 4 AIM (Add In Module) slots that can be fitted with host or field network modules. Only one host AIM can be fitted; only one Modbus RTU AIM can be fitted; up to two <i>Pakscan</i> Classic AIMS can be fitted. There are two field network AIM types.</p> <p><i>Pakscan</i> Classic (P4720). Modbus RTU (P4724).</p> <p>Both field network protocols are described briefly below:</p> <p><i>Pakscan</i> Classic (P4720):</p> <ul style="list-style-type: none"> • Redundant loop topology. • Does NOT require external repeaters or external termination. • Network total length up to 20 km. • No limitation for distance between FCUs within the 20 km limit. • A single network can control 240 FCUs. • Data transfer via robust current loop network. • Network baud rate ranges between 110 to 2400. • Network scan rate (60 FCUs on 4 km loop) less than 1 second. • Twisted pair instrumentation cable (1 pair). • Communications parameters set up using handheld tool via network or using actuator menu. • Ideal for isolating duty applications. <p>Modbus RTU (P4724):</p> <ul style="list-style-type: none"> • Standard open Modbus protocol. • Compatible with any manufacturer's Modbus device. • Single highway, dual highway or redundant loop topology. • Single and dual highway option standard Modbus topology. • Redundant loop 1.2 km maximum distances between FCUs. • Network Baud rate up to 115k200. • A single network can control up to 240 FCUs. • Ideal for isolating duty applications.
FCU connectivity	<p>The maximum number of FCUs that can connect to a <i>Master Station</i> is 240. When ordering a <i>Master Station</i>, select the appropriate maximum FCU count for the application. It is possible to order <i>Master Stations</i> for 60, 120, 180 or 240 FCUs.</p> <p>The following devices can be connected to the Rotork <i>Master Station</i>:</p> <p>Any Rotork electric actuator with a:</p> <ul style="list-style-type: none"> • <i>Pakscan</i> Classic (current loop) network interface card (A, AQ, Q, IQ, IQT, SI, EH, CVA, CMA, ROMpak, CK). • Modbus network interface card (Q, IQ, IQT, SI, EH, CMA, ROMpak, CK). <p>Any Rotork switch box or pneumatic / hydraulic actuator fitted with a:</p> <ul style="list-style-type: none"> • <i>Pakscan</i> Classic General Purpose Field Control Unit (GPFCU). <p>Any Rotork Modbus enabled device such as:</p> <ul style="list-style-type: none"> • Bifold Orange controller <p>Any third party manufacturers Modbus device:</p> <ul style="list-style-type: none"> • Contact Rotork for details of how to integrate
Communication between the Master Station and the Host	<p>Standard: 2 off RJ45 Ethernet (10/100/1000 Mbps) connections supporting Modbus TCP, located on each CPU module (module P4710).</p> <p>Other services on the Ethernet connection are: Web server (built in web pages).</p> <p>Option: Host Serial AIM (module P4727). Serial communications via, 2 off 9-way D-type connections supporting Modbus RTU. Individually configurable RS-232 to RS-485 via DIP switches. Termination for RS-485 enabled via HMI or web pages (resistor network 120 Ω passive with 1 kΩ biasing). Termination stays in place on power down. Baud rate 2,400 to 115,200.</p> <p>A hot standby system contains duplicate modules so the number of host connections is doubled. With the standard CPU and optional Host Serial AIM installed, a total of four host connections of each type is available.</p>
Service port	<p>Standard: 1 off RJ45 Ethernet port (10/100/1000 Mbps) for temporary connection to a computer. Intended for service or configuration use only. Supports the same Ethernet services as the host connection.</p>

3. Rotork Master Station Technical Datasheet *continued*

Rotork Master Station Features <i>continued</i>	
Redundancy	<p>Standard: A single <i>Master Station</i> consists of a <i>Master Station</i> rack into which the following units can be connected: Display module; PSU module (P4740); CPU module (P4710) Up to four total AIMS: Field Network: <i>Pakscan</i> Classic (P4720) Field Network: Modbus RTU (P4724) Host Serial AIM (P4727)</p> <p>In a single unit all of these modules will be arranged on the left side of the <i>Master Station</i> rack. Leaving the right side free.</p> <p>The single <i>Master Station</i> has redundant host connections to the CPU module and the field networks can be redundant loops.</p> <p>Option: For full redundancy, the hot standby <i>Master Station</i> contains a primary (side A, left) set of modules as described above and identical redundant standby (side B, right) set of modules. The primary side ensures the standby side is continually updated with the status of all the connected FCUs such that it can take over control of the field network in the event of a failure of the primary module or if the request to change masters is received. The standby will also take over the communications to the host network.</p> <p>Change over time is less than 500 ms for the field network communications.</p>
User interface	<p>Standard: No specialist software required to configure system. Can be configured fully via Local touch screen Interface or built in web pages.</p> <p>Each <i>Master Station</i> contains at least 1 local touch screen interface – 2 in the case of a hot standby or dual unit.</p> <ul style="list-style-type: none"> • Size: 7.0" • Resolution: 1024 x RGB x 600 <p>The local and web based interfaces have an identical structure, creating a consistent user interface across both platforms. The user interface is focused towards quick device setup, interrogation and issue resolution.</p> <p>Both interfaces enable:</p> <ul style="list-style-type: none"> Viewing of status, alarms and settings for the <i>Master Station</i>, field network, host network and FCUs. Configuration of settings for the <i>Master Station</i>, field network, host network and FCUs. Viewing of host communication logs. Viewing of <i>Master Station</i> datalogger and FCU event logs. <p>In addition, the web interface enables:</p> <ul style="list-style-type: none"> Saving of Host analyser and <i>Master Station</i> datalogger files. Upgrading the <i>Master Station</i> software. Saving of <i>Master Station</i> alarm logs.
Example Data	
From actuators to the Master Station	<p>This is not a complete list of data available. For a full list of data refer to PUB059-052 <i>Master Station</i> Full Configuration Manual.</p> <p>Input Data: Digital position indication (OPEN / CLOSE / MID) Analogue position indication Position of control selector switch (LOCAL / STOP / REMOTE) Direction of operation indication Indication of undesired torque trip (mid travel, directional) Analogue Torque value indication Motor stall indication General Fault indication</p> <p>Output Data: Operation commands to actuators (OPEN / CLOSE / STOP / ESD / SETPOINT) Relay operation commands to General Purpose Field Control Units (GPFUCU) and Actuators</p>
From Master Station to the Host (available over Modbus interface)	<p>This is not a complete list of data available. For a full list of data refer to PUB059-052 <i>Master Station</i> Full Configuration Manual.</p> <p>Input Data: Data from FCUs; <i>Master Station</i> status information Communication status of the FCUs; Alarm status of the FCUs</p> <p>Output Data: Operation commands to actuators; ESD command to <i>Master Station</i></p>
Operating Conditions	
Enclosure	Standard: IP20
Environment	<p>Standard: Operating temperature: 0 to +50 °C (+32 to +122 °F) Storage temperature: -10 to +70 °C (+14 to +158 °F) Humidity: 5% to 95% RH, non-condensing Vibration: 5-150 Hz, acceleration 0.7 gn peak Shock: 2 gn peak Located: indoors</p>
Weight	Hot standby and dual configuration: approx. 7 kg; Single configuration: approx. 6 kg
Approvals	
Standards	Directive 2014/30/EU and SI 2016 No. 1091 on Electromagnetic Compatibility EN 61326-1:2013 (Intended for use in an industrial electromagnetic environment) Directive 2014/35/EU and SI 2016 No. 1101 on Electrical Equipment (Safety) EN 61010-1:2010+A1:2019 (Safety requirements for electrical equipment for measurement, control, and laboratory use)
Useful Documentation	
Manual	PUB059-050 Safe Use, Installation and Maintenance Manual PUB059-052 Full Configuration manual
Product information	PUB059-047 Sales Flyer PUB059-048 Sales Brochure

4. Health and Safety

This manual is produced to enable a competent user to install the Rotork *Master Station*. Only persons competent by virtue of their training or experience should install, maintain and repair the Rotork *Master Station*.

Under no circumstances should replacement parts be used in the *Master Station*, other than those supplied or specified by Rotork.

Work undertaken must be carried out in accordance with the instructions in this and any other relevant manuals.

If the *Master Station* is used in a manner not specified in this manual and any other Rotork manual, the protection provided by the *Master Station* may be impaired.

The user and those persons working on this equipment should be familiar with their responsibilities under any statutory provisions relating to the Health and Safety of their workplace. Due consideration of additional hazards should be taken when using the *Master Station* with other equipment. Should further information and guidance relating to the safe use of the Rotork *Master Station* be required, it will be provided on request.

The electrical installation, maintenance and use of the *Master Station* should be carried out in accordance with National Legislation and Statutory Provisions relating to the safe use of this equipment, applicable to the site of installation.

For the UK: Electricity at Work Regulations 1989 and the guidance given in the applicable edition of the IET Wiring Regulations BS 7671 should be applied. The user must be fully aware of their duties under the Health and Safety Act 1974.

For the USA: NFPA70, National Electrical Code® is applicable.

For Canada: CEC, Canadian Electrical Code, is applicable.

Or any applicable local regulations or legislative requirements

The mechanical installation must be carried out as outlined in this manual and also in accordance with relevant standards such as British Standard Codes of Practice.

The *Master Station* must only be installed in areas appropriate to its certification and must not be installed in hazardous area locations.

Under no circumstances should any modification or alteration be carried out on the *Master Station* as this could invalidate the *Master Station* warranty and certification.

Care must be taken to ensure the voltages and currents do not exceed those specified for the *Master Station* and the correct polarity is applied.

Galvanically isolated input or output signal circuits are provided by certain products. A competent person must decide upon the safety status of such circuits when connected to other devices, and treat them accordingly.

 **CAUTION: Service Altitude**

The *Master Station* installation altitude must be restricted to less than 2000 m as defined by IEC61010-1 (Safety requirements for electrical equipment for measurement, control and laboratory use).

 **WARNING: Emergency Shutdown**

Emergency Shutdown (ESD) functionality is configurable within the *Master Station*. An ESD command issued from the *Master Station* may cause connected devices to move without prior warning. As default the ESD function is switched off.

 **WARNING: Operation of devices connected to the *Master Station***

The *Master Station* is an actuator controller, therefore the user should ensure that any necessary additional safety measures are considered for each actuator connected to the *Master Station*.

 **CAUTION: Enclosure Materials**

The *Master Station* is manufactured from aluminum, metal filled plastic, printed circuit boards, glass display, stainless steel screws.

The user must ensure the operating environment and any materials surrounding the *Master Station* cannot lead to a reduction in the safe use of, or the protection afforded by, the *Master Station*. Where appropriate, the user must ensure the *Master Station* is suitably protected against the operating environment.

 **WARNING:** Actuators connected to the *Master Station* may start and operate when remote is selected. This will be dependent on remote control signal status and actuator configuration.

 **CAUTION: Do not use solvents for cleaning.**

Clean the front panel with a damp lint-free cloth and mild detergent.

 **WARNING: Electro-static discharge**

It is important to wear appropriate anti-static protection equipment when removing, handling or installing *Master Station* modules (AIMs) to prevent damage from electro-static discharge.

5. Installation

Mechanical Fixing

Appropriate clearance space should be maintained around the *Master Station*, allowing for a suitable bending radius on connecting cables and allowing for the doors to be fully raised to ensure easy access or removal of AIMs.

The equipment can be used as:

- Panel mounted: positioned on a vertical surface using the panel-mount option kit. The brackets are provided with 7 mm x 11 mm slots for appropriately sized (6 mm) fixing bolts.
- Rack-mounted: in a standard 19" rack using the rack-mount option kit. The brackets are provided with 7 mm x 11 mm slots for appropriately sized (6 mm) fixing bolts. The two bracket positions permit flush or protruded (by 40 mm) mounting of the *Master Station*.
- Free standing: on a horizontal surface.

In all cases the *Master Station* should be located in a way that permits easy access to the touch screen interface and disconnection of the power supply.

! CAUTION: Do not obstruct the air cooling outlet and inlet vents on the top and underside. Free flow of air around the *Master Station* must be maintained, especially at high ambient temperatures.

Single *Master Station* rack mounted

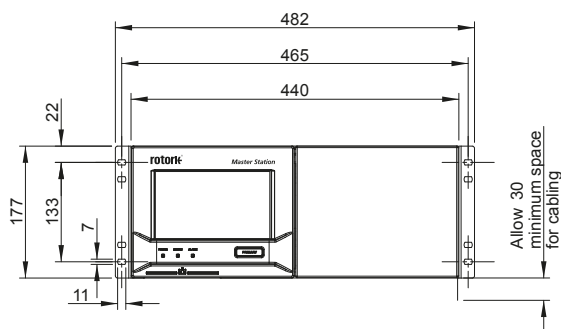

Side view with bracket in 19" rack mounting position

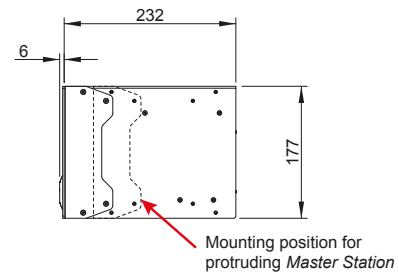

Hot Standby *Master Station*, wall mounted

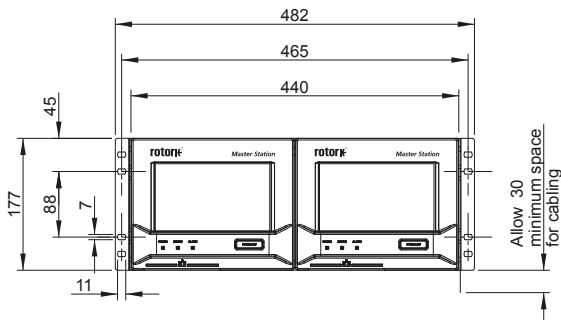

Side view with bracket in wall mounting position

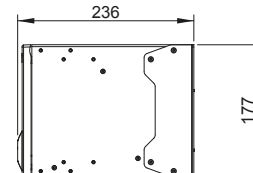

Bottom view
Hot Standby *Master Station*, wall mounted

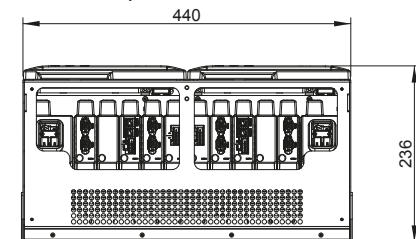

Side view with bracket in 19" rack mounting position
Doors open

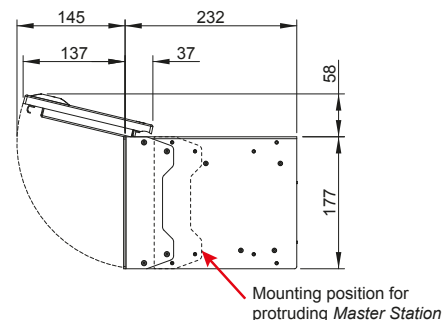

Doors open
Hot Standby *Master Station*, rack mounted

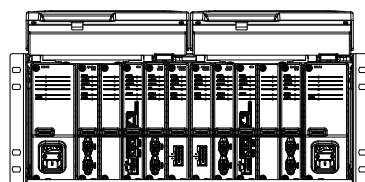

All dimensions in mm

5. Installation *continued*

Nameplate

Every *Master Station* includes a nameplate detailing serial number and model number. The serial number uniquely identifies the *Master Station* and can be used by the Rotork factory to trace the manufacturing details of the unit. This is a useful reference for upgrades and spares enquiries. The model number defines the build configuration of the *Master Station*, whether it is hot standby, dual or single configuration, the power supply rating, how many FCUs can be connected and which Add In Modules (AIMs) are fitted.



Location of Nameplate

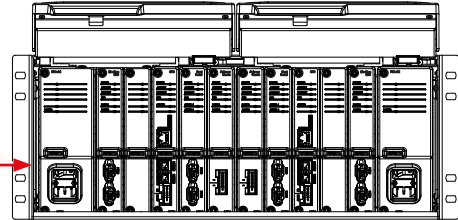

The red text below indicates the decoding of the model number 311B2BB1B2BB1: a *Master Station* with hot standby, AC PSU, Pakscan Classic field network, 120 channels (FCUs).

Enclosure		Left Hand Side						Right Hand Side					
Rack		PSU LH	Option 1 LH	Option 2 LH	CPU LH	Option 3 LH	Option 4 LH	Option 1 RH	Option 2 RH	CPU RH	Option 3 RH	Option 4 RH	PSU RH
1	Single	1 AC	1 Classic Field	1	1 60 Channels	1	1	1	1	1	1	1	1
2	Dual		2 Future	2	2 120 Channels	2	2	2	2	2	2	2	B
3	Hot Standby		3 Future	3	3 180 Channels	3	3	3	3	3	3	3	
			4 Modbus Field	4	4 240 Channels	4	4	4	4	4	4	4	
			5 Future	5	5 Future	5	5	5	5	5	5	5	
			6 Future	6		6	6	6	6	B	6	6	
			7 Host Serial	7		7	7	7	7		7	7	
			B Blank	B		B	B	B	B		B	B	

Power Connector and Ratings Label

The power connector supplied with the *Master Station* is an IEC 60320 C13 type with a locking mechanism. The red latch must be pulled when connecting or disconnecting the power connector from the *Master Station*. Power rating information is shown on every PSU module next to the power connection. The example below shows information for an AC PSU module.

Lower view of AC PSU module (P4740)



Note: The *Master Station* is only supplied with the power connector. Customers must supply their own power cable.

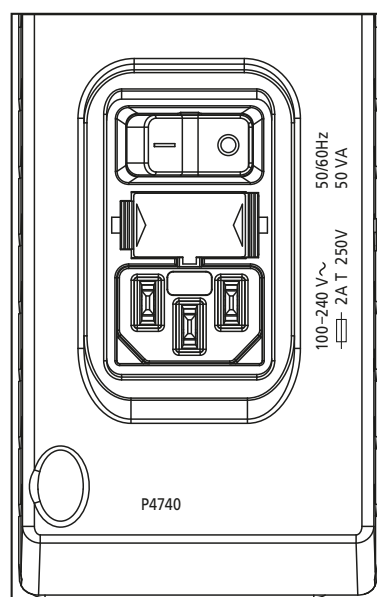

6. Basic Commissioning

This section is intended to get the user started with a *Master Station*, for more detailed information about the *Master Station* and how to fully commission field networks please refer to the *Master Station Full Configuration Manual* (PUB059-052). Red text refers to a **setting** or **menu** within the *Master Station* interface.

Settings can only be changed on the primary side of a Hot Standby *Master Station*.

Administrator level access is required for commissioning.

Login Process

The user name and password for the *Master Station* can be found on the test certificate, delivered with the *Master Station*. Contact your local Rotork representative to arrange a replacement if the test certificate is not present. *Master Station* is provided with only an Administrator account from the factory.

The Administrator user name and password should be changed as soon as possible to improve security.

The *Master Station* on screen keyboard does not include a full set of characters. It is advisable to change the password on screen instead of through a web browser to ensure the password is compatible. Refer to PUB059-052 for details of the on screen keyboard.

Viewer permits read only access.

User permits limited editing access.

Administrator permits full editing access and creation of additional viewer, user and administrator accounts.



Fig. 6.1 Select menu

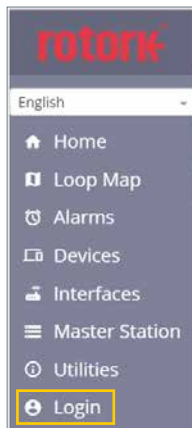

Fig. 6.2 Select Login



Fig. 6.3 Enter Administrator login credentials

Connecting to Ethernet Service Port

The *Master Station* can be directly connected to a Laptop/PC via the Ethernet Service port. In order to establish a connection to the *Master Station* it is likely the laptop/PC internet connection settings will have to be adjusted to a fixed IP address arrangement. To set a static IP address for your device, follow appropriate online instructions for the operating system of the Laptop/PC. To connect to a *Master Station* with default settings, configure the static IP address to the values below.

Laptop/PC IP address = 10.201.1.3

Laptop/PC subnet mask = 255.255.255.0

It may be necessary to restart the Laptop/PC to apply the new internet settings.

The default IP address of the *Master Station* service port is 10.201.1.1. Enter this IP address into the web browser of the connected Laptop/PC to open the home page of the *Master Station*.

If the IP address of the *Master Station* has been changed, this can be viewed via the touch screen interface in the *Master Station* settings. The Laptop/PC must be configured within the same IP range and subnet mask to communicate.

The *Master Station* service port must be on a different Class C network to the Ethernet 1 and Ethernet 2 ports.

6. Basic Commissioning *continued*

Host Communication Settings

The *Master Station* includes Ethernet host communication as standard or Serial host communication with the optional Host Serial AIM. Some communication settings are common to Ethernet and Serial.

Common settings:

These settings apply to Ethernet and Serial host communication.

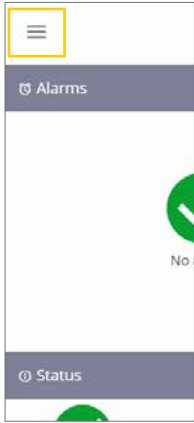

Fig. 6.4 Select menu

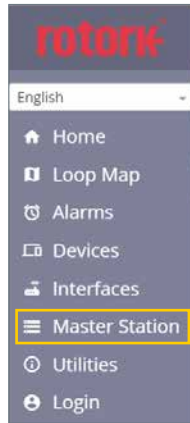

Fig. 6.5 Select Master Station

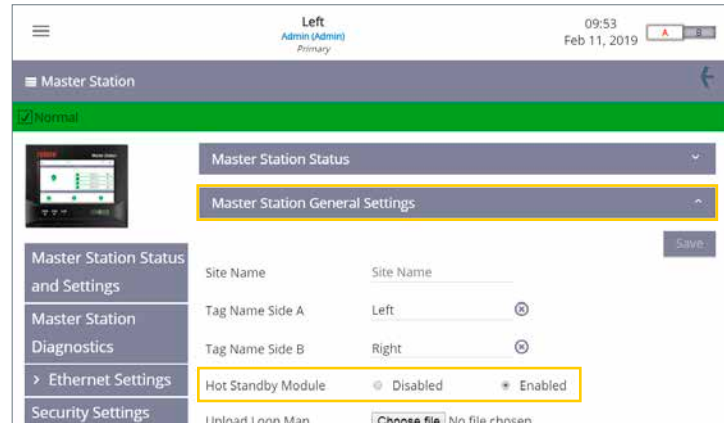

Fig. 6.6 Select Master Station General Settings

Master Station General Settings tab: **Hot Standby Module** should be set to Disabled for a single or dual *Master Station* and Enabled for a hot standby *Master Station*. Check this setting on both sides of a dual or hot standby *Master Station*.

! CAUTION: The Hot Standby Module setting must be correctly configured to avoid potential damage to the *Master Station* or connected FCUs on a *Pakscan Classic* field network loop. The hot standby Y loom must never be used when Hot Standby Module is set to Disabled.

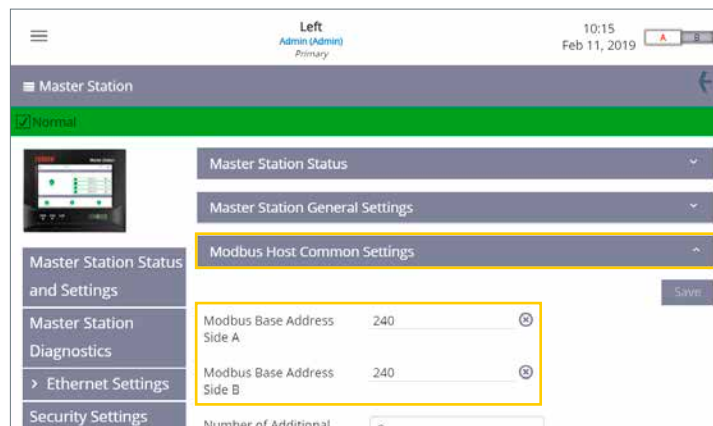

Fig. 6.7 Modbus Host Common Settings

Modbus Host Common Settings tab: **Modbus Base Address Side A** and **Modbus Base Address Side B** define the communication address to side A and side B. These must be different for a dual *Master Station*. A hot standby *Master Station* is normally configured for the same Modbus address on both sides but this is not mandatory.

6. Basic Commissioning *continued*

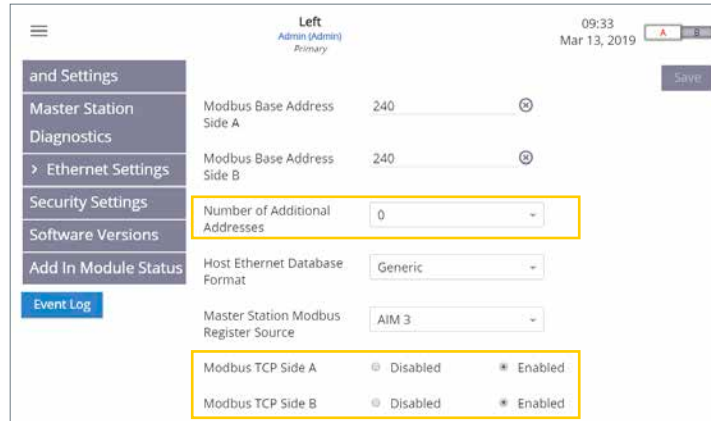

Fig. 6.8 Modbus Host Settings

Configure the **Number of Additional Addresses** for the number of FCUs supported by the *Master Station* or the range of FCU addresses in use. The table below advises what value to set depending on the *Master Station* FCU count. FCU count is shown on the *Master Station* test certificate.

Master Station total FCU count	Setting for Number of Additional Addresses
60	0
120	1
180	2
240	3

Host Ethernet Database Format should be configured to match the database type in use. The database used for serial communication is configured within the Host Serial interface settings.

Master Station Modbus Register Source should be set to All AIM if there are multiple field network AIMS installed. If a single field network AIM is installed, select the appropriate AIM number. The test certificate will detail the location of the installed AIMS. AIM 1 refers to AIM slot 1, AIM 2 refers to AIM slot 2, AIM 3 refers to AIM slot 3 and AIM 4 refers to AIM slot 4. Refer to section 2 for slot locations.

Modbus TCP Side A and **Modbus TCP Side B** should be enabled if using Modbus TCP.

6. Basic Commissioning *continued*

Ethernet Settings

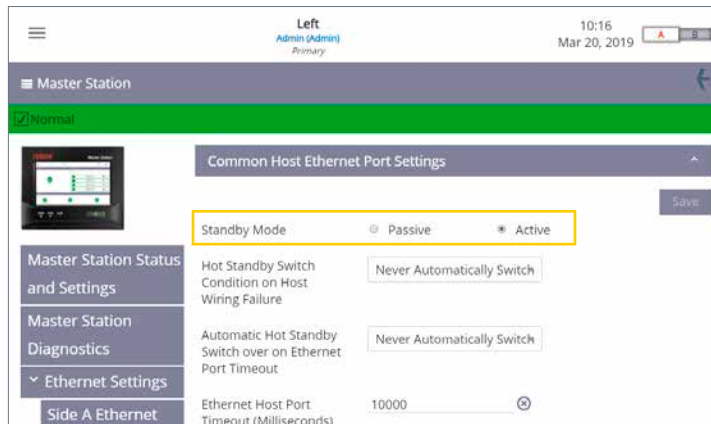

Fig. 6.9 Common Host Ethernet Port Settings

Hot Standby *Master Station* only.

Standby Mode must be configured correctly for the Ethernet network topology. Passive standby mode means only the primary side will communicate over Ethernet. Active standby mode means both primary and standby sides will communicate. Special consideration should be given to the IP address of the primary and standby sides as duplicate active IP addresses are not permitted on the same physical network.

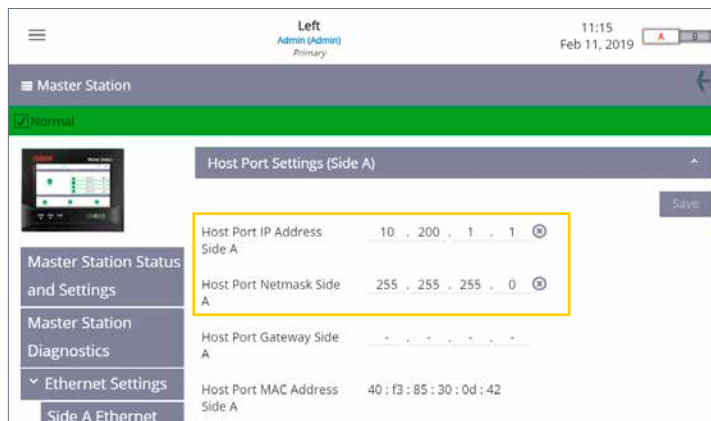

Fig. 6.10 Host Port Settings for Side A

Side A Ethernet and **Side B Ethernet** settings allow the user to configure the IP address information for the *Master Station*. Each page includes a tab for host port settings and a tab for service port settings.

Only the **Host Port IP Address** and **Host Port Netmask** need to be set.

A single *Master Station* requires only side A to be configured. A dual *Master Station* requires side A to be configured on side A and side B to be configured on side B. Hot standby *Master Station* requires side A and side B to be configured.

6. Basic Commissioning *continued*

Host Serial Settings

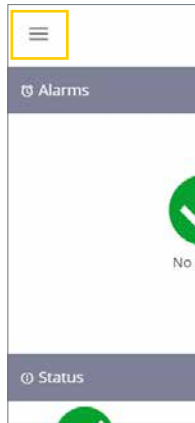

Fig. 6.11 Select menu

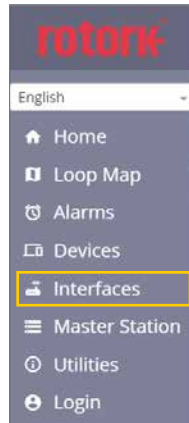

Fig. 6.12 Select Interfaces

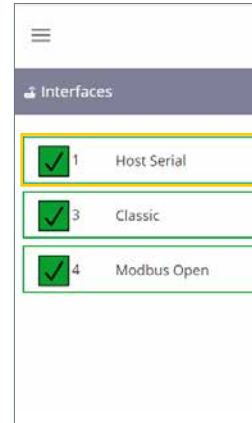

Fig. 6.13 Select Host Serial

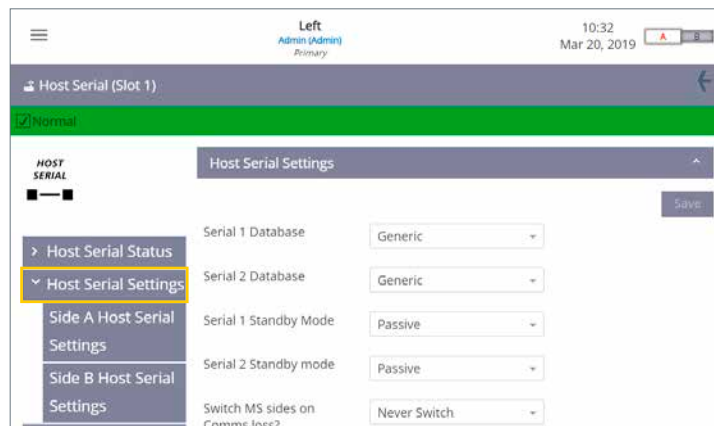

Fig. 6.14 Select Host Serial Settings

Host Serial Settings define the database used for Modbus Host communications.

Default setting for the database is Generic. The communication settings, baud rate and parity are configured for each side of the *Master Station*.

Hot standby *Master Station* only.

Standby Mode can be configured as Active or Passive on a hot standby *Master Station*. **Standby Mode** is often determined by the communication type; RS-232 (point to point connection) should be Active and RS-485 (both sides connected together) should be Passive.

Side A and side B must be configured identical for hot standby *Master Station*.

A physical switch on the Host Serial AIM is used to configure communication using RS-485 or RS-232. The default configuration of Host Serial ports is one set to RS-485 and the other set to RS-232. This makes initial communication testing possible without the need to adjust settings. Serial 1 and Serial 2 are identical and have the same priority in the *Master Station* therefore it does not matter which is used. The factory default for Serial 1 is RS-485 and Serial 2 is RS-232.

6. Basic Commissioning *continued*

Host Serial Type Selection

1. Open the *Master Station* display door to access the fitted modules.
2. Isolate the *Master Station* power supply using the switch on the PSU module.
3. Unscrew the top and bottom fixings that hold the module in place. Screws are captive so will not unscrew fully.

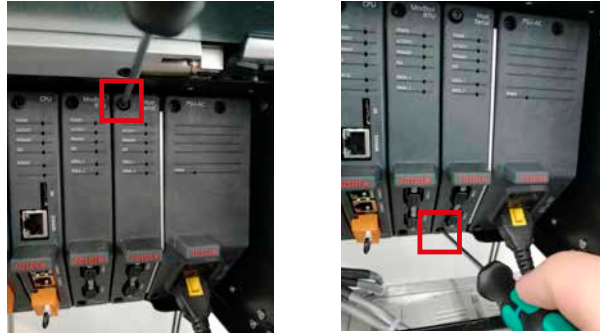

4. Pull the tab outwards away from the *Master Station* to remove the module. It is important to pull outwards in a smooth linear motion to avoid twisting the module and potentially damaging PCB components.



5. Adjust the DIP switches to the desired position for each serial port. SW1 (CH1) determines the setting for Serial 1. SW2 (CH2) determines the setting for Serial 2. Move the switch up to set RS-232 or down to set RS-485.

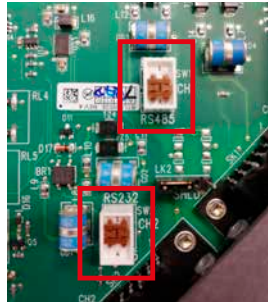

6. After both switches are configured for the correct communication type, refit the module by performing the reverse of disassembly. Each AIM slot includes plastic guides to ensure the PCB aligns correctly with the *Master Station*. Check the top and bottom of the PCB are within the plastic guides before fully inserting the AIM into the *Master Station*.



7. Tighten the fixing screws and power on the *Master Station*. After a few minutes, check the Host Serial AIM is communicating with the *Master Station*.

6. Basic Commissioning *continued*

Pakscan Classic Field Network

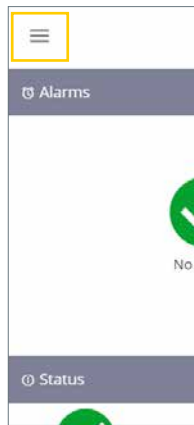

Fig. 6.15 Select menu

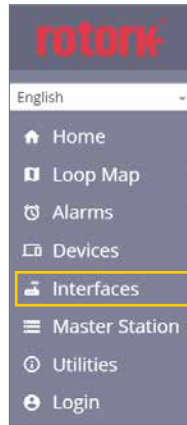

Fig. 6.16 Select Interfaces

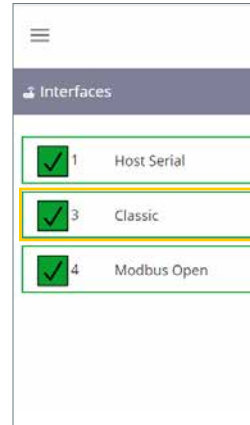

Fig. 6.17 Select Classic

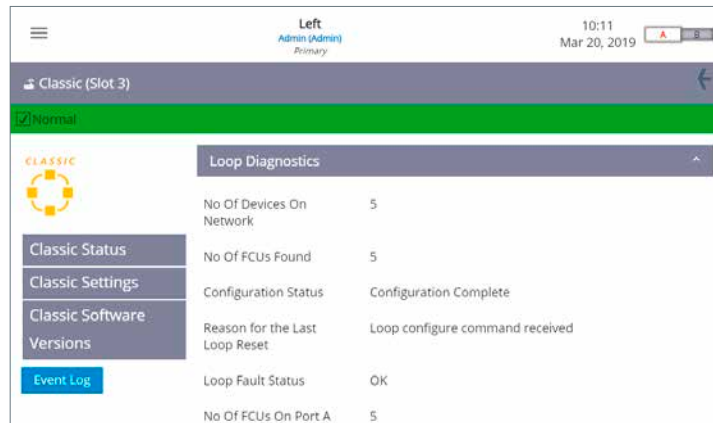

Fig. 6.18 Pakscan Classic Loop Diagnostics

Classic Status details the current state of the classic loop and the connected FCUs.

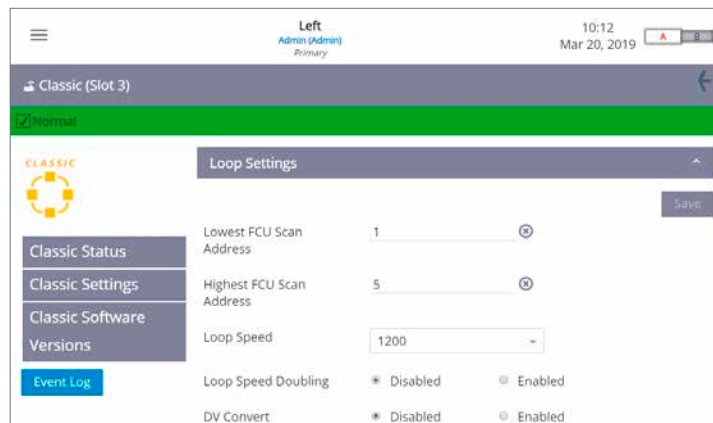

Fig. 6.19 Pakscan Classic Loop Settings

The **Lowest FCU Scan Address** and **Highest FCU Scan Address** must be set*. If multiple classic field networks are installed, address ranges must not overlap ensuring each FCU has a unique address on the *Master Station*. **Loop Speed** must be configured to an appropriate value taking into account loop distance, cable specification and number of connected FCUs. Refer to PUB059-011 for guidance on loop speed calculation.

*These settings define how many FCUs (field control units) the classic AIM should scan for and which addresses they are. The individual FCUs must be configured with a unique address within this range.

6. Basic Commissioning *continued*

Modbus Open Settings

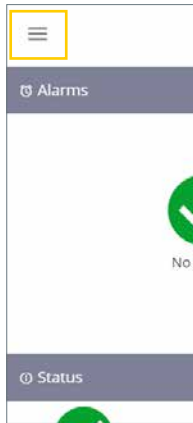

Fig. 6.20 Select menu

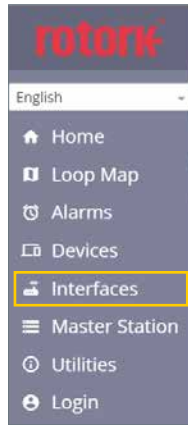

Fig. 6.21 Select Interfaces

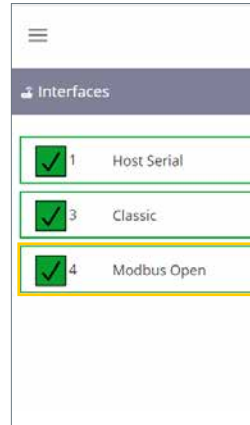

Fig. 6.22 Select Modbus Open

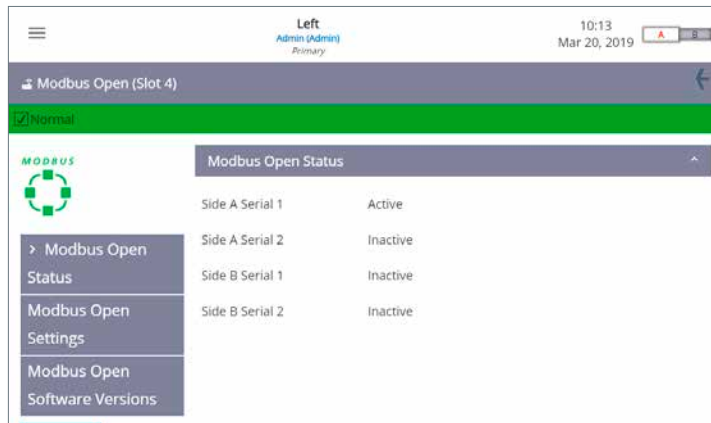

Fig. 6.23 Modbus Open Status

Modbus Open Status details the current state of the Modbus RTU loop and the connected FCUs.

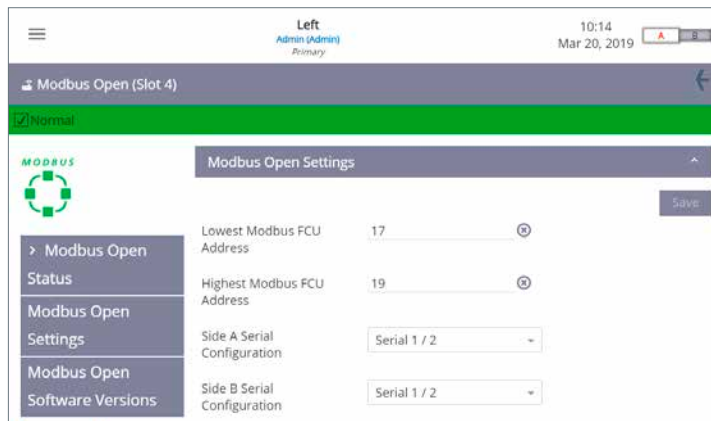

Fig. 6.24 Modbus Open Settings

The **Lowest Modbus FCU Address** and **Highest Modbus FCU Address** must be set*. **Baud Rate** must be configured to an appropriate value taking into account loop or highway distance and segment length. Refer to standard Modbus RTU specification documentation for guidance on appropriate baud rate setting.

*These settings define how many FCUs (field control units) the Modbus RTU AIM should scan for and which addresses they are. The individual FCUs must be configured with a unique address within this range.

6. Basic Commissioning *continued*

In order for the *Master Station* to identify Modbus FCUs, a Device File must be created that defines the FCU type code against the Modbus address of each FCU.

The Device File is a plain text file in a CSV (Comma Separated Values) format.

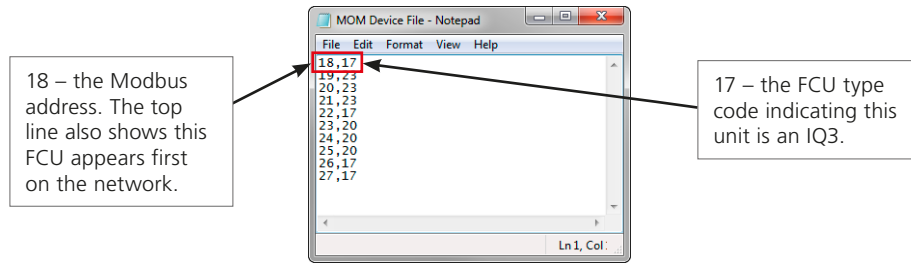

Fig. 6.25 Modbus Device File

A Device File can be created directly in a Text Document editor such as Notepad. Each row of the Device File represents a Modbus FCU. Each row consists of the Modbus FCU address and the applicable FCU Type Code, separated by a comma. The order of Modbus addresses will represent the order that FCUs appear on the network. The FCU Type Code defines the type of FCU the *Master Station* is communicating with.

For large network loops with many FCUs, a Device File can be created using a spreadsheet program such as Excel. Column A should contain the Modbus FCU address and Column B should include the FCU Type Code. Only one Modbus FCU is permitted per row. Separation with commas is not necessary when using Excel.

One row per Modbus device. The file must always be saved as '.csv' format.

A sample of Modbus FCU Type Codes are detailed in the following table:

Value (dec)	Description	Value (dec)	Description
12	CVL	18	IQT3
13	CVQ	20	CMA
14	ROMpak	21	SI3
17	IQ3	23	Centronik (CKc)

Refer to PUB059-052 for a full list of Modbus FCU Type Codes.

The Device File is uploaded to the *Master Station* from the **Modbus Open Settings** screen

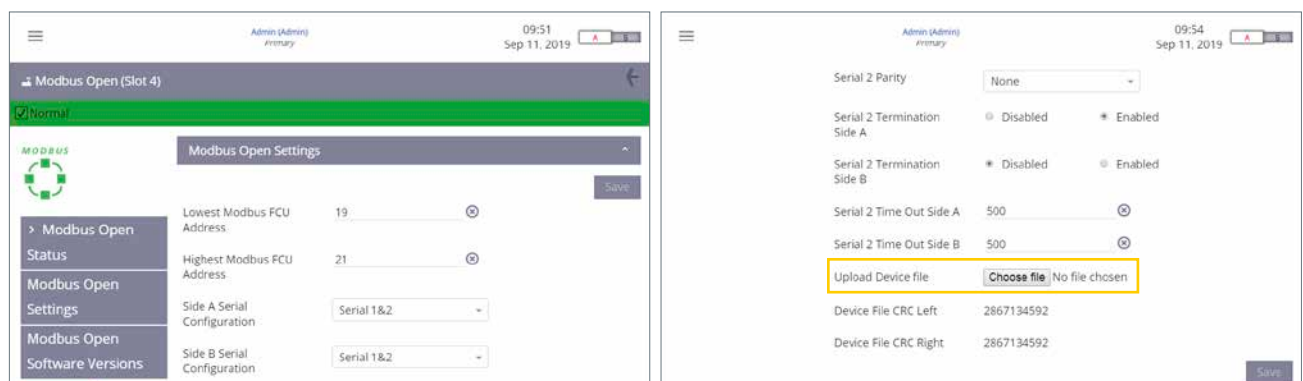

Fig. 6.26 Upload Modbus Device File

Communication to Modbus RTU FCUs cannot occur until the Device File is uploaded to the *Master Station*. The file will need to be loaded into both sides of a hot standby *Master Station*.

For changes to settings it is advisable to use the Service Port connection (rather than host connections).

7. Environmental

End user advice on disposal at end of life of the product.

In all cases, check local authority regulation before disposal.

Subject	Definition	Remarks / examples	Hazardous	Recyclable	EU Waste code	Disposal
Electrical & Electronic Equipment	Printed circuit boards	All Products	Yes	Yes	20 01 35	Use specialist recyclers
Electrical & Electronic Equipment	Wire	All Products	Yes	Yes	17 04 10	Use specialist recyclers
Glass	Display	Touch Screen Display	No	Yes	16 01 20	Use specialist recyclers
Metals	Copper/Brass	Wire	No	Yes	17 04 01	Use licensed recyclers
Metals	Aluminium	Enclosure	No	Yes	17 04 02	Use licensed recyclers
Plastics	Stainless steel fibre filled ABS	Plug in module Fascias	No	No	17 02 04	Disposal as general commercial waste
Plastics	Unfilled	Enclosure	No	Yes	17 02 03	Use specialist recyclers

All electronic components used in the manufacture of the *Master Station* conform to the Restriction of Hazardous Substances Directive 2011/65/EU.

8. Fuses

AC mains: 5 mm x 20 mm, 2 A fuse current, 250 VAC, 1,500 A breaking capacity, time delay.

Damaged fuses must be replaced with the fuse type mentioned above and must be pre-certified types to the IEC 60127 or ANSI/UL 248 series.

9. Vibration and Shock

The Rotork *Master Station* is suitable for installation in locations where vibration and shock severity does not exceed the following:

Type	Level
Vibration	Frequency range 5 to 150 Hz, acceleration 0.7 gn peak
Shock	2 gn peak

10. EMC

BS EN61326-1:2013 Immunity levels for industrial environment. Emissions limit class B

To ensure conformity with Directive 2014/30/EU and UK SI 2016 No. 1091, installation should adopt the following cable arrangements:

All digital data cables and all analogue signal cables operating at or below 50 V should be shielded either by braid, armouring or metal conduit. Such shields should be earthed at the point of entry to the product enclosure using cable glands designed for this purpose. If, for the avoidance of ground loops, it is not possible to earth these shields locally at low frequencies, they should be earthed by a capacitor effective at radio frequencies. If this technique is adopted, it is the users' responsibility to ensure that EMC is not compromised. A single shield may be shared by multiple analogue signal cables.

All Ethernet cables must be screened and of good quality. Many screened Ethernet cables of low quality have questionable screening capability.

11. Safety

EN61010-1:2010+A1:2019 Safety requirements for electrical equipment for measurement, control, and laboratory use.

IEC 61010-1:2010 Safety requirements for electrical equipment for measurement, control, and laboratory use.

UL Std. No. 61010-1 (3rd Edition) Safety requirements for electrical equipment for measurement, control, and laboratory use.

UL Std. No 61010-2-201 (1st Edition) Safety Requirement for Electrical Equipment for Measurement, Control, and Laboratory Use - Part 2-201: Particular requirements for control equipment.

CAN/CSA-C22.2 No. 61010-1-12: Safety requirements for electrical equipment for measurement, control, and laboratory use.

CAN/CSA-IEC 61010-2-201-14 Safety Requirements for Electrical Equipment for Measurement, Control, and Laboratory Use - Part 2-201: Particular requirements for control equipment.

Directive 2014/35/EU and SI 2016 No. 1101 on Electrical Equipment (Safety).

12. Storage

If the *Master Station* cannot be installed immediately, store it in its original box in a dry place.

In most cases it is not necessary to remove the *Master Station* modules during commissioning and installation. The exception is where the serial physical layer requires changing from RS-232 to RS-485. Rotork cannot accept responsibility for damage caused on-site during removal or replacement of these modules by untrained personnel.

Every Rotork *Master Station* is fully tested before leaving the factory.

rotork®



www.rotork.com

A full listing of our worldwide sales and service network is available on our website.

UK
Rotork plc
tel +44 (0)1225 733200
email mail@rotork.com

PUB059-050-00
Issue 07/21

As part of a process of on-going product development, Rotork reserves the right to amend and change specifications without prior notice. Published data may be subject to change. For the very latest version release, visit our website at www.rotork.com

The name Rotork is a registered trademark. Rotork recognises all registered trademarks. Published and produced in the UK by Rotork. POLTG0821