

rotork®

Keeping the World Flowing
for Future Generations

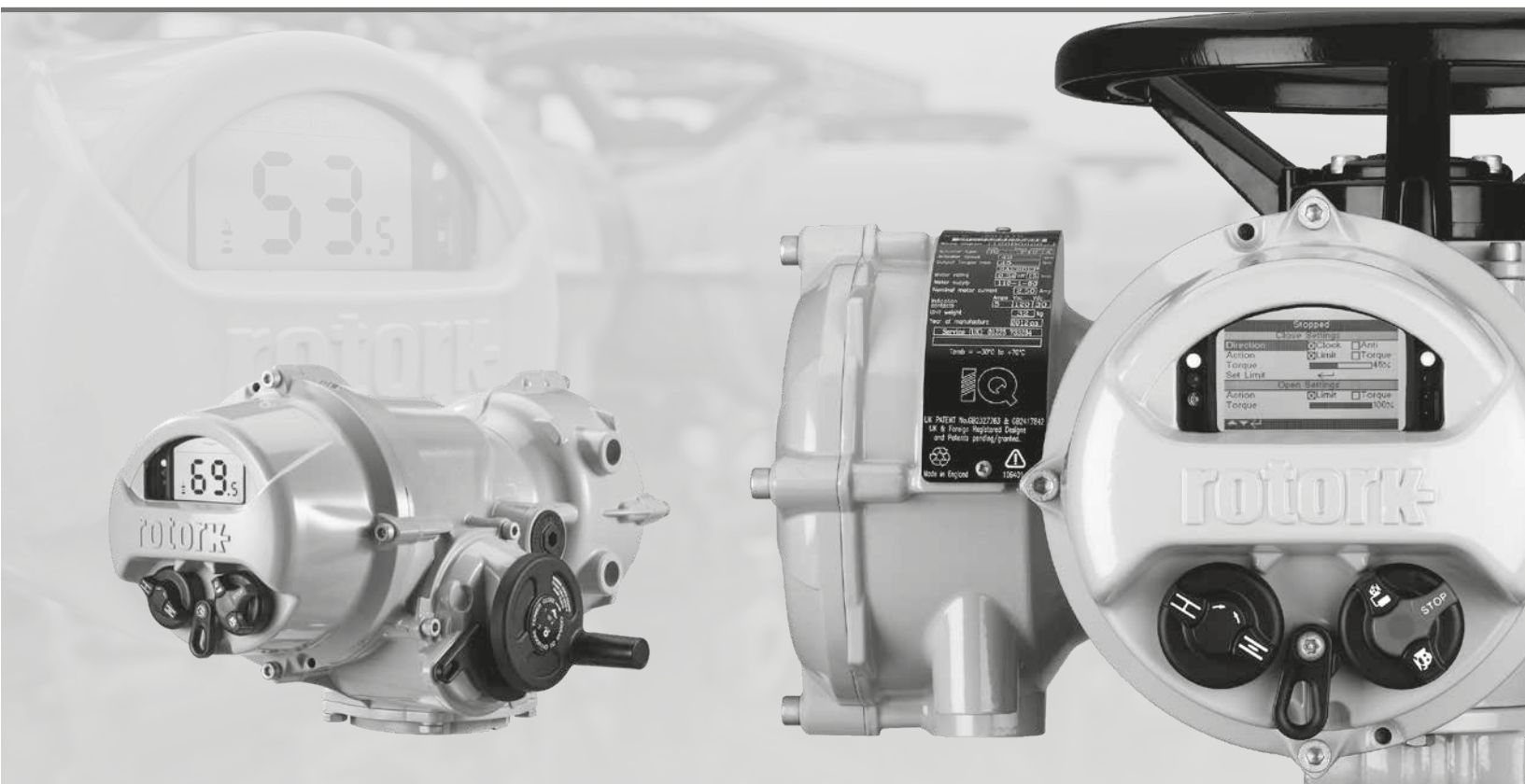



IQ Range 

IQ and IQT full configuration,
status and monitoring user manual



IQ Multi-Turn and IQT Part-Turn Electric Valve Actuators



	1. Introduction _____ 3
	1.1 Using the Rotork Setting Tool _____ 4
	1.2 Connecting to the actuator _____ 6
	1.3 Password Security _____ 7
	2. Settings _____ 8
	2.1 Limits _____ 8
	2.2 Indication _____ 11
	2.3 Control _____ 14
	2.4 ESD _____ 35
	2.5 Security _____ 37
	2.6 Defaults _____ 38
	3. Status _____ 39
	3.1 Control _____ 39
	3.2 Alarms _____ 44
	3.3 Movement _____ 45
	3.4 Indication _____ 46
	3.5 Diagnostics _____ 47
	4. Data Log _____ 48
	4.1 Torque Logs _____ 49
	4.2 Event Logs _____ 51
	4.3 Trend Logs _____ 55
	4.4 Operation Logs _____ 58
	4.5 Partial Stroke Logs _____ 62
	4.6 Set Log Date _____ 63
	5. Assets _____ 64
	5.1 Actuator _____ 65
	5.2 Valve _____ 68
	5.3 2nd Stage Gear Box _____ 68
	5.4 Service History _____ 69
	5.5 Service Alarms _____ 69
	5.6 NAMUR 107 _____ 70
	5.7 Online Help _____ 71

1. Introduction

 This manual provides instruction on the setup and analysis of the actuator.

It is structured so that instruction on using the Setting Tool, navigation and password security is contained in Section 1. This must then be applied when changing settings and viewing information as set out in Sections 2 - 5.

The user must therefore be familiar with the operations contained in Section 1 before proceeding.

This manual should be read in conjunction with PUB002-039 IQ Range Instructions for Safe Use, Installation, Basic Setup and Maintenance and PUB002-065 IQT Range Instructions for Safe Use, Installation, Basic Setup and Maintenance supplied with the actuator.



1.1 Using the Rotork Setting Tool

The Setting Tool is used to connect to the actuator, navigate through menus, change settings and view information presented on the actuator display.

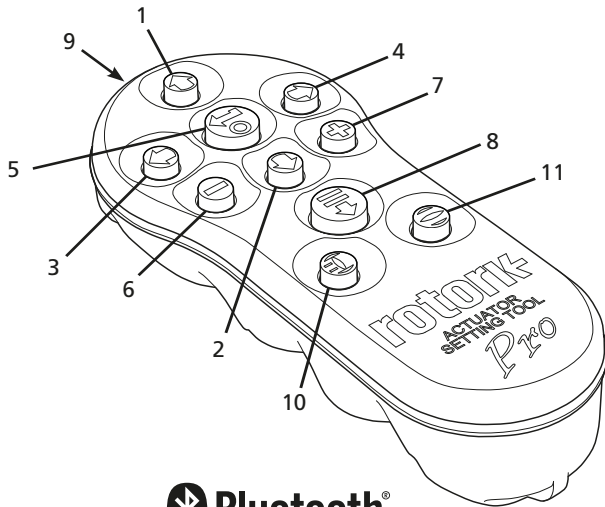

Name	General Operation
1.	Scroll up.
2.	Scroll down / Connect via <i>Bluetooth</i> [®] .
3.	Decrease value / Toggle setting / Scroll left.
4.	Increase value / Toggle setting / Scroll right.
5.	Select the highlighted item. Save the highlighted setting. Stop actuator running (when Setting Tool control is enabled, refer to 2.3.1).
6.	Return to previous menu.
7.	Cycle between standard and zoom view on data logger torque graphs.
8.	Actions the pre-configured mission stored on the Rotork <i>Bluetooth</i> [®] Setting Tool <i>Pro</i> .
9.	Infrared transmitter window.
10.	Send a close command to the connected actuator (when enabled refer to 2.3.1).
11.	Send an open command to the connected actuator (when enabled refer to 2.3.1).

Navigation

To navigate through screens, menus and pages, the and keys are used. A single key press results in one movement. Holding the key will result multiple movements in succession. Menus, pages and dropdowns wrap round. This means that an item at the bottom of a screen can be accessed by pressing while at the top.

Shorthand Instructions

This manual uses shorthand instruction (example): (meaning select, edit setting, save) to prompt the user with the key operations required. The display will also indicate the relevant keys at the bottom left.

Pages, Functions and Index

The display indicates the number of each function as it is highlighted along with the total number of functions on that page. In the example below, Action is function 2 out of a total of 15 functions on that page: 2/15

This manual uses the display function number as reference for instructions.

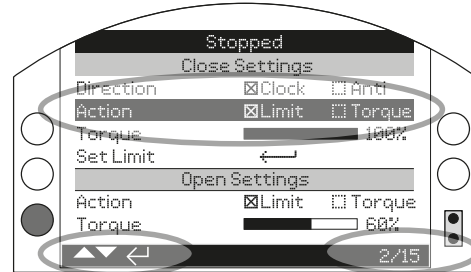

Action (highlighted) is function 2 out of a total 15 on the LIMITS page.

Selection

The key is used to select a main menu item, menu items or instruction buttons. For a setting, is used to select when a change is required. The first time this occurs in a communication session, a password will be requested, refer to 1.3. Subsequent changes within the same session will not require the entry of a password. When selected, a menu item will be opened or a setting or function will be highlighted.

Information, instruction and password entry screens require an or button to be selected. Navigate to highlight the required button using or and press to select.

Setting controls

There are four types of setting control used. When a function is selected, the ability to change the function, setting or value is made available using drop down list boxes, check boxes, slider controls or numerical values.

Drop down list boxes

Drop down list boxes are indicated by .

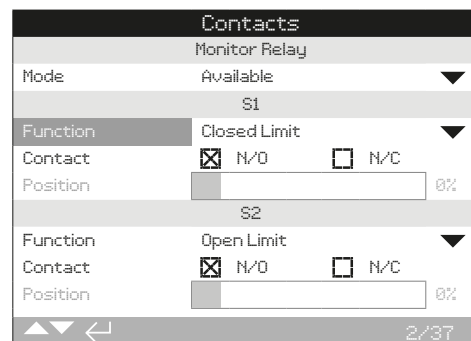

The example of the S1 indication contact Function (highlighted) dropdown list box is shown on the next page. When selected (password entered if applicable, refer to 1.3), the current set function will be highlighted within the drop down list.



The symbol ▼ in the drop down box indicates more functions are available by scrolling ⬆ or ⬇.

Use ⬆ or ⬇ to scroll through the list until the required function is highlighted. Press ⬅ to select. The drop down list box will close and the selected function will be saved and shown on the page.

To exit the drop down list without saving a new setting press ⬅ to return to the previous page.

Checkboxes

Check boxes are indicated by or .

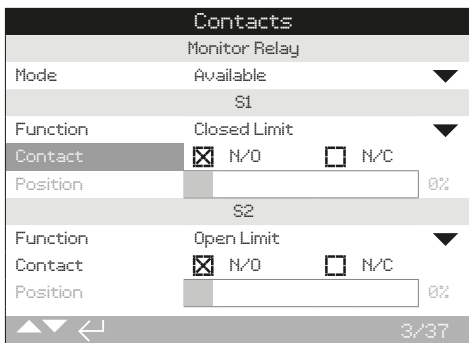

An example for the S1 indication contact type check box is shown above.

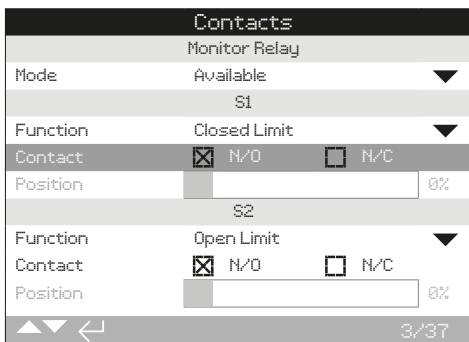

When selected (password entered if applicable, refer to 1.3), the current mode will be highlighted.

Use either the ⬆ or ⬇ to toggle between modes.

Once the required mode is checked, press ⬅ to select. The selected mode will be saved and shown as checked on the page.

To exit the checkbox without saving a new setting, press ⬅ to return to the page.

Slider controls

Slider controls graphically indicate the set value followed by the exact numerical value, for example:



The range covered by the slider is fixed and is determined by its function.

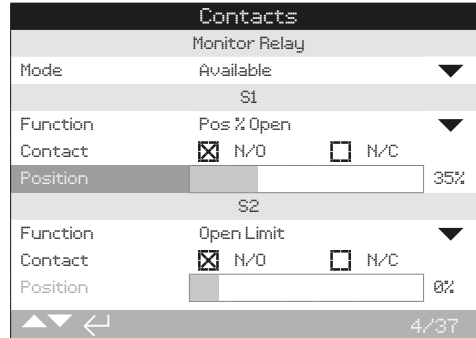

An example of the S1 indication position value is shown above. The S1 contact function of Pos.% Open indication will show the valve position at which the contact will change state.

Press ⬅ (enter password if applicable, refer to 1.3). Use ⬆ or ⬇ to decrease or increase the value.

Slider controls wrap round so a ⬆ key press on a minimum value will wrap round and indicate the maximum value. The value step changes increase as ⬆ or ⬇ is held down.

Once the required value is set press ⬅ to select. The selected value will be saved and shown on the page.

To exit the slider control without saving a new setting, press ⬅ to return to the page.

Numerical values

Numerical values relate to fields such as time or address - shown in the example below.

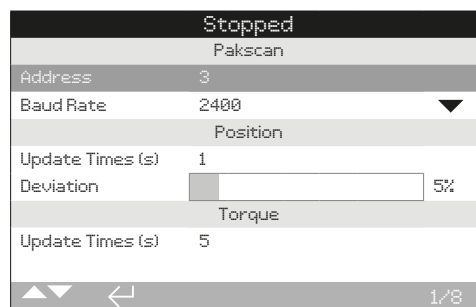

Press ⬅ (enter the password if applicable, refer to 1.3).

Use ⬆ or ⬇ to decrease/increase the numerical value. Press ⬅ to select.

To exit the numerical value control without saving a new value, press ⬅ to return to the previous page.



1.2 Connecting to the actuator

The Rotork Bluetooth® Setting Tool *Pro* incorporating Bluetooth wireless technology is shown below. It is identified by the key symbols and a clear band between the top and bottom casings being transparent.

The Rotork Infrared Setting Tool *Pro* is identified by solid yellow keys and a yellow band between casings:



Yellow: Rotork Infrared Setting Tool *Pro*
Clear: Rotork Bluetooth® Setting Tool *Pro*

Connecting to the actuator using Bluetooth

The actuator must be powered up to connect using Bluetooth. The default security set in the actuator for Bluetooth connection is by initiation using an infrared command. This means that the user must be in close proximity and in direct line of sight of the actuator.

Point the Setting Tool at the infrared sensor located at the lower right of actuator display window within a range of 0.25 m (10 in) and press until the key flashes blue.

The screen will change to the Main Menu screen.

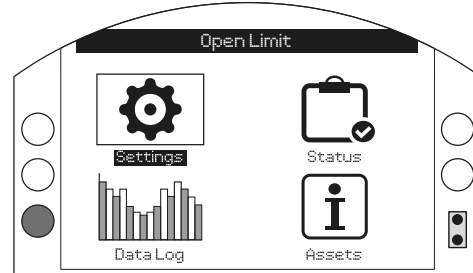

The Setting Tool will automatically connect using Bluetooth which takes up to 5 seconds.

Connection is indicated by a blue light on the tool and in the actuator display window. Once connected, the tool can be used without pointing it at the actuator display window.

Bluetooth connection will be maintained while Setting Tool key commands are made. After a period of 6 minutes with no key commands, Bluetooth connection will be turned off and the Setting Tool and display blue lights will go out. To manually disconnect Bluetooth at any time, press and together.

Connecting to the actuator using Infrared

Infrared communication is used when:

- Bluetooth communication has been disabled (refer to 2.5).
- configuration is required without power being applied to the actuator.
- legacy infrared only Rotork Setting Tool is used (yellow banded tool).

The Infrared only tool has solid yellow keys and a yellow band between casings.

Communication is by direct line of site infrared commands within a range of 0.25 m (10 in). Keys have the same function as shown in this manual. Each key press sends a discreet infrared command and therefore the tool must be in range.

1.3 Password Security



Menus, pages and settings may be viewed when the actuator is set to Remote, Stop or Local. To change a setting, the actuator must be selected to Local or Stop using the red selector and the correct password must be entered.

The password will be requested the first time a function is selected. Once correctly entered, other changes can be made without re-entering the password for the duration of the Setting Tool session with the actuator.

If the actuator is selected to Remote and a setting is selected, the following information screen will be displayed:

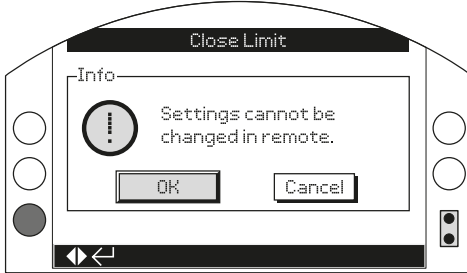

Press to return to the page. Set the red selector to Local or Stop to proceed with setting.

With the actuator selected to Local or Stop and when any setting function is selected, the Password screen will be displayed:

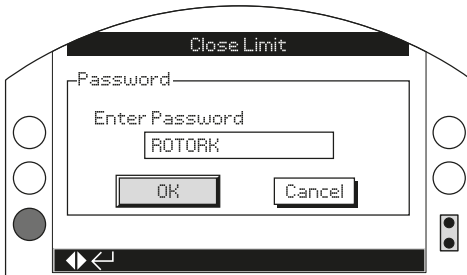

The factory set default password ROTORK is displayed and the OK button is highlighted.

Press . The setting page from which the function was selected will be displayed with the function highlighted.

If the user has set their own password the following screen will be displayed:

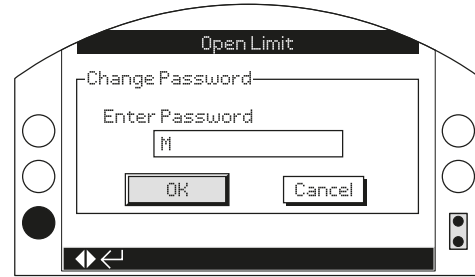

Enter user selected Password:

Use to highlight new password entry box and press .

Use to scroll through alphanumeric values to display required character.

Use to move to the next character.

Use to delete the highlighted character.

Use when selected password is complete.

Navigate to the OK button using . Press .



2. Settings menu	Page
2.1 Limits	8
2.2 Indication	11
2.2.1 Contacts	11
2.2.2 Local Display	12
2.2.3 Analogue	14
2.3 Control	14
2.3.1 Local	15
2.3.2 Remote	16
2.3.3 Interrupter Timer	32
2.3.4 Shutdown Battery	33
2.4 ESD	35
2.5 Security	37
2.6 Defaults	38

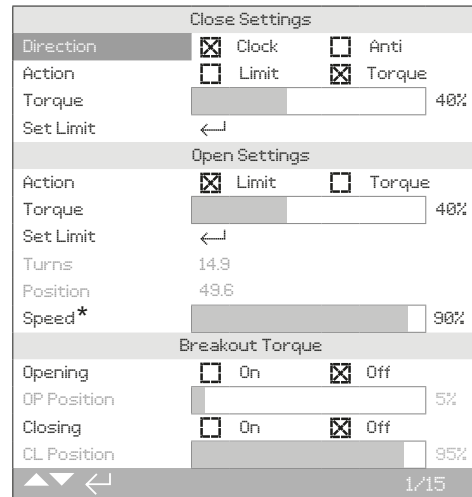

* IQT builds only

The Limits page is shown above with the default settings.

For SET enabled actuators, refer to PUB002-039 for correct setup procedure.





Close Settings

1/15 Close Direction

Sets the output rotation direction required to close the valve. Using the handwheel, manually operate the actuator to establish valve closing direction.

Clock (default) – clockwise rotation of the actuator closes the valve.

Anti – anti-clockwise (counter clockwise) rotation of the actuator closes the valve.

To change,    . The checkbox will indicate the set closing direction.

2/15 Close Action

The actuator can be configured to close on torque for seating valve types or limit for non-seating valve types.





Refer to Valve manufacturer for recommended setting. In the absence of valvemaking instruction refer to the following table:

2.1 Settings – Limits *continued*

Valve Type	Close Action	Open Action
Wedge gate	Torque	Limit
Globe	Torque	Limit
Butterfly	Limit	Limit
Through conduit	Limit	Limit
Ball	Limit	Limit
Plug	Limit	Limit
Sluice gate	Limit	Limit
Penstock	Limit	Limit
Parallel slide	Limit	Limit

Limit (default) – The actuator will move the valve to the set Closed Limit position and stop.

Torque – The actuator will move the valve to the set Closed Limit position and then apply the set torque (3/15) to seat the valve.

To change,    . The checkbox will indicate the set closing action.





3/15 Close Torque

The value of torque available to close the valve can be limited between 40% and 100% of its nameplate rated torque. If the actuator experiences the set torque when closing between the limits, it will stop and must then be reversed before it will move closed again. Operational torque can be monitored using the data log (refer to 4) and using the torque-position home screen (refer to 2.2.2).

The default setting for closed torque limit is 40%. If a value of torque was specified at time of order, the % value equating to the specified torque will have been set by Rotork.

If the actuator was delivered complete with valve, the valvemaking may have set the closed torque limit based on testing and/or design requirements.

In the absence of valvemaking instruction, set the minimum value required to close the valve under process conditions.

To change,    . The slider will indicate the set closing torque value.

4/15 Close Limit

Limits must only be set when the actuator is coupled to the valve.

The minimum number of output turns between set Closed and Open Limits is 2.5 or 30° (IQT). A Closed Limit position cannot be set if the actuator is at its set Open Limit or within 2.5 (30°) turns of an Open Limit position. Should a condition arise where this occurs, for example where an actuator at its Closed Limit position is coupled to a valve at its open position, refer to 2.6 Defaults - Limits.

If the actuator was delivered complete with valve, the valvemaking should have set the Closed and Open limit position, refer to testing below.

The Closed Limit position must be set by moving the actuator to the valve Closed Limit position and pressing .

The actuator will display the following Instruction:

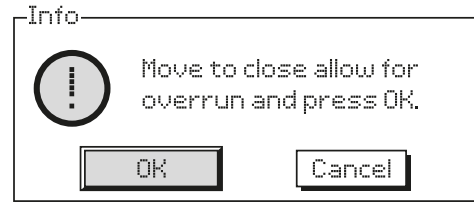

Move the actuator and valve to the close position. Allow for overrun by winding open by ½ to 1 output turn.

Press  to select OK.

The Closed Limit will be set at the current valve position. If not previously illuminated, the closed indication LED (default green, refer to 2.2.2) will be turned on.

Testing: The limit position can be confirmed by opening the actuator until the indication LED changes colour and then moving closed until the Closed Limit indication LED colour is turned on at the set Closed Limit position.

Open Settings





5/15 Open Action

The actuator can be configured to open on torque for back-seating valve types or limit for non back-seating valve types.

 **Refer to valve manufacturer for recommended setting. In the absence of valvemaking instruction set open action to Limit.**

Limit (default) – The actuator will move the valve to the set Open Limit position and stop.

Torque – The actuator will move the valve to the set Open Limit position and then apply the set torque (6/15) to back-seat the valve.

To change,    . The checkbox will indicate the set opening action.

6/15 Open Torque

The value of torque available to open the valve can be limited between 40% and 100% of its nameplate rated torque. If the actuator experiences the set torque when opening between the limits, it will stop and must then be reversed before it will move open again. Operational torque can be monitored using the data log (refer to 4) and using the torque-position home screen (refer to 2.2.2).

The default setting for open torque limit is 40%. If a value of torque was specified at time of order, the % value equating to the specified torque will have been set by Rotork.

If the actuator was delivered complete with valve, the valvemaking may have set the closed torque limit based on testing and/or design requirements.

In the absence of valvemaking instruction, set the minimum value required to open the valve under process conditions but higher than that set for closed torque.

To change,    . The slider will indicate the set limit of opening torque value.

7/15 Set Open Limit

Limits must only be set when the actuator is coupled to the valve.

The minimum number of output turns between set Open and Closed Limits is 2.5. An Open Limit position cannot be set if the actuator is at a set Closed Limit position or within 2.5 turns of a Closed Limit position. Should a condition arise where this occurs, for example where an actuator at its Open Limit position is coupled to a valve at its closed position, refer to 2.6 Defaults - Limits.

If the actuator was delivered complete with valve, the valvemaker should have set the Closed and Open limit positions, refer to testing below.

The Open Limit position must be set by moving the actuator to the valve Open Limit position and pressing .

The actuator will display the following Instruction:

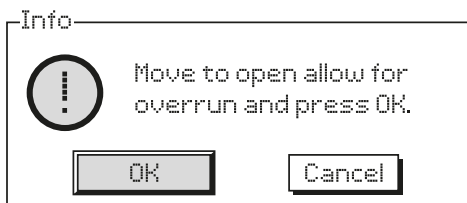

Move the actuator and valve to the open position. Allow for overrun by winding closed by ½ to 1 output turn.

Press  to select OK.

The Open Limit will be set at the current valve position. If not previously illuminated, the open indication LED (default red, refer to 2.2.2) will be turned on.

Testing: The limit position can be confirmed by closing the actuator until the indication LED changes colour and then moving open until the Open Limit indication LED is turned on at the set Open Limit position.

8/15 Turns



Shows the actuator output turns between the set Closed and Open Limit positions.

9/15 Position (non-editable)

Shows the actuator current position on 0-100%.

10/15 Speed (IQT only)

The default speed for a standard IQT is 100% (rated) or 50% for IQTM. Speed can be adjusted to suit operation/process needs.

To change,    . The slider will indicate the current set speed.





Breakout Torque

The default setting for opening and closing breakout torque is Off (torque protection active at all times). Bypassing the torque protection allows torque up to approximately 150% of rated to be available.

The valve maker or integrator should be consulted to confirm the valve structure and interface components can withstand the additional torque/thrust.

11/15 Opening





Opening torque limit protection can be bypassed over a portion of the opening stroke, refer to 12/15. When set to On, torque of up to approximately 150% of rated is available for opening "sticky" valves.

To change,    . The checkbox will indicate the set opening breakout torque status.

12/15 Opening Position





When opening breakout torque is set to On (refer to 11/15), the position over the opening stroke where torque limit protection is bypassed can be set. If breakout torque open is set to Off, the opening bypass position control will be greyed out.

The available position range over which torque limit protection is bypassed is 0% (Closed Limit) to 95% open. Outside the set bypass position, torque switch protection will revert to that set for 6/15.

To change,    . The slider will indicate the set position range over which opening torque limit is bypassed.

13/15 Closing





Closing torque limit protection can be bypassed over a portion of the closing stroke, refer to 14/15. When set to On, torque of up to approximately 150% of rated is available for closing the valve.

To change,    . The checkbox will indicate the set closing breakout torque status.

14/15 Closing Position

When closing breakout torque is set to On (refer to 13/15), the position over the closing stroke where torque limit protection is bypassed can be set. If breakout torque closed is set to Off, the closing bypass position control will be greyed out.

The available position range over which torque limit protection is bypassed is 100% (Open Limit) to 5% open. Outside the set bypass position, torque switch protection will revert to that set for 3/15.

To change,    . The slider will indicate the set position range over which closing torque limit is bypassed.

15/15 Auto Limit Setting

Sets the open and close limits automatically. Then end of travel for the lower and upper limits is established when 40% torque has been reached in each direction. The Actuator must be in Local to complete this function.



Instruction is provided on:

- 2.2.1 Contacts
- 2.2.2 Local display
- 2.3.3 Analogue

2.2.1 Indication – Contacts

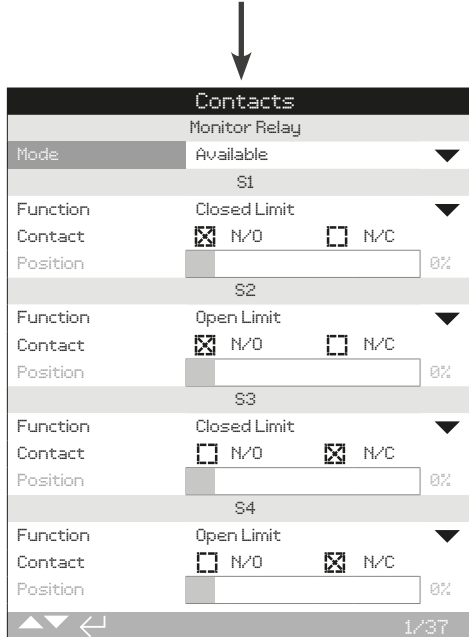
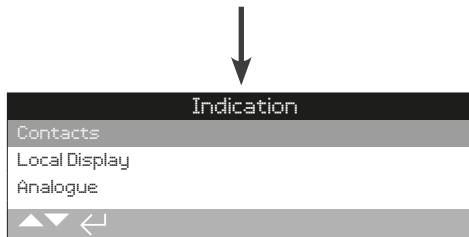

The Monitor Relay and S contact settings page is shown in their default setting.

Refer to actuator wiring diagram for available contacts.

1/37 Monitor Relay – Mode

The monitor relay provides remote indication of actuator status. It provides a volt free change over contact, refer to actuator circuit diagram. There are 2 modes that can be set:

Available (default) – Actuator available for remote control. Monitors power supplies, motor thermostat, detected internal fault and remote control selected. A loss in one or more will cause the monitor relay to de-energise indicating "not available" for remote control.

Fault – Actuator fault. Monitors power supplies, motor thermostat and detected internal fault. A loss in one or more will cause the monitor relay to de-energise indicating "actuator fault".

To change the mode, . The drop down list box will close and the selected mode will be shown:

S Contact function, contact type and position

Each relay contact can be set to one of the functions shown in the table below and its contact type can be set as Normally Open (NO) or Normally Closed (NC). If Pos % Open function is selected, the position at which the relay operates can be set. For all other functions the position control slider will be greyed out.

Standard Contacts S1-S4, Option S5-S8 and S9-S12
Contacts when fitted

The method for setting all S contacts is the same. S1 to S4 are fitted as standard. A further 8 extra contacts are available as options grouped: S5 to S8 and S9 to S12, refer to actuator wiring diagram. If extra contacts are fitted their configuration screens are accessed by scrolling down. If not fitted their configuration settings will be greyed out.

2/37 Contact Function

The available contact functions included in the drop down list box are shown below.

To change the contact function, . The drop down list box will close and the selected function will be shown:

Function	Indication:
Disabled	Contact disabled
Closed Limit	Closed limit position (exact)
Open Limit	Open limit position (exact)
End Position	Both Closed and Open Limit positions
Pos % open	Set position mid-travel – opening and closing
Mid Travel	Not at Closed or Open Limits
Motor Running	Motor running
Closing	Travelling in the close direction - motor or handwheel
Opening	Travelling in the open direction - motor or handwheel
Moving	Travelling – motor or handwheel
Handwheel	During handwheel operation
Blinker	Travelling (make/break at 1 second intervals)
Valve Alarm	On torque trip mid-travel or motor stall condition
Torque Trip CL	Torque trip closing - any position
Torque Trip OP	Torque trip opening - any position

Continued over page

Function	Indication:
Torque Trip	Torque trip closing or opening - any position
Torque Trip Mid	Torque trip mid-travel, closing or opening
Motor Stall	At limit, motor energised – no output movement detected
Mid Travel Stall	Not at limit, motor energised – no output movement detected
Stop Selected	Red selector set to STOP
Local Selected	Red selector set to Local
Remote Selected	Red selector set to Remote
Control Alarm	ESD signal and/or interlock active
Monitor	Monitor relay de-energised
ESD Active	ESD signal applied
OP Interlock Active	Open Interlock active
CL Interlock Active	Close interlock active
Interlock Active	Open and/or closed interlock active
Actuator Alarm	Internal fault detected
Motor Over Temp	Motor thermostat has tripped
Lost Phase	3-phase only: monitored phase 3 lost
24 V Supply Fail	Internal 24 VDC supply failed (Terminals 4 & 5)
P Stroke Active	Partial stroke underway
P Stroke Fail	Partial stroke not completed
P Stroke Pass	Partial stroke completed
Bluetooth	Bluetooth communication in progress
Battery Low	Battery low
Battery Discharged	Battery discharged or missing
Digital Output	Network option controlled
Maintenance	Scheduled maintenance due
Hi Torque Alarm	Set Hi torque value reached
Hi Hi Torque Alarm	Set Hi-Hi torque value reached
Src 1 Coms Loss	Communication failure with option 1 card
Src 2 Coms Loss	Communication failure with option 2 card
NAMUR Maint.	A NAMUR maintenance condition is active
NAMUR Out Of Spec.	A NAMUR out of specification condition is active
NAMUR Func. Check	A NAMUR function check condition is active
NAMUR Failure	A NAMUR failure condition is active
Over Modulation	Starts per hour has been exceeded
Motor Enable	Active when motor enable is inhibiting electrical operation
Maintain Enabled	Open/Close signals are maintained
HMI Loss	HMI will not be lit up
General alarm	Anything which constitutes an alarm from the 'function' list triggers this alarm
Bat Backup Avail	Checks availability of battery, checks if battery is charged
Bat Backup Ctrl	Checks if the battery is in control





If NAMUR 107 relay functions are used, refer to 5.6 for NAMUR 107 condition settings.

3/37 Contact

Each relay contact output can be configured as normally open (make on condition) or normally closed (break on condition).

N/O - The contact will complete the circuit when the set function is present, normally open, refer to 2/37 Contact Function.





N/C - The contact will break the relay circuit when the set function is present, normally closed, refer to 2/37 Contact Function.

To change use    . **The checkbox will indicate the selected contact type.**

2.2.2 Indication – Local Display

4/37 Position

If the relay function relates to an actuator position, for example Pos % Open, this setting will become available to edit. Range 0% - 100%.

To change use    . **The slider control will indicate the set position value.**

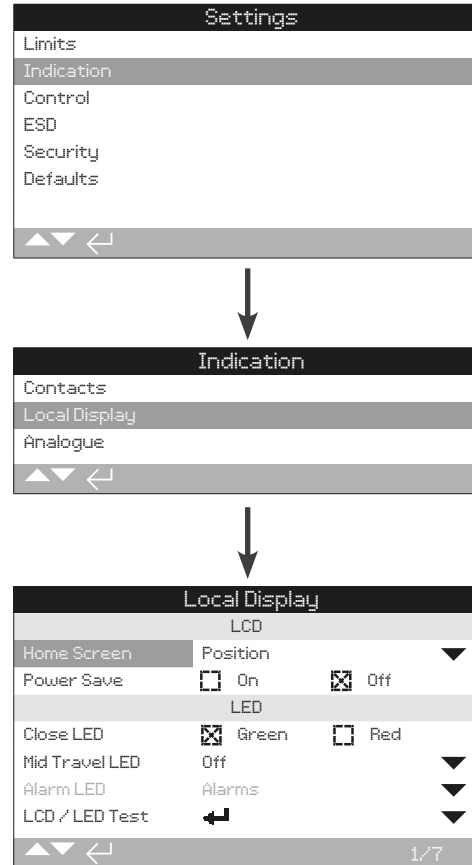

The Local Display settings page is shown in its default setting.



LCD

The displayed home screen language can be selected and power save mode can be activated.

1/7 Home Screen

Refer also to PUB002-039 (IQ) or PUB002-065 (IQT)

Available Home screens included in the drop down list box:

Position (default) - Display indicates the current valve position to one decimal place. Icons are used for closed  and open  limit positions.

Torque (A) + Pos – Display indicates current valve position to one decimal place as Position (above) plus analogue torque indication scaled 0% to 100% of rated torque, shown at the top of the display.

Torque (D) + Pos – Display indicates current valve position to one decimal place as Position (above) plus digital torque indication scaled 0% to 99% of rated torque. If the actuator develops torque greater than 99% then "Hi" will be displayed.

2.2.2 Indication – Local Display *continued*

Positioner – Used only with analogue or network position control. Display indicates current valve position (▼) to one decimal place plus the position equating to the applied demand signal (▽). In addition, an analogue indication of demand and position is provided scaled 0% to 100% of valve position.





To set the home screen,    . The drop down list box will close and the selected home screen will be indicated.

2/7 Power Save

The LCD has a white backlight to maximise contrast of the segment display and matrix characters. It may be switched off when not required if a bright display is disruptive within its environment.

Off (default) - The display backlight is permanently illuminated when the actuator is powered up.

On - The display backlight automatically switches off when the actuator is not operating. The segments/matrix remain on. The display backlight will switch on when the local control selectors are moved, electrical or handwheel operation takes place or when the Setting Tool is communicating with the actuator. The backlight will switch off again approximately 30 seconds after the above events have taken place.

To change the power save mode,    . The checkbox will indicate the selected mode.





LED

The function of the display green, red and yellow LED lights can be set.

3/7 Close Colour

Green (default) – The green lights illuminate at the Closed Limit position, red at open.

Red – The red lights illuminate at the Closed Limit position, green at open.

To change the Closed Limit position indication light,    . The checkbox will indicate the selected closed colour.

4/7 Mid Travel LED

On (default) – The yellow lights are on when mid-travel.





Off – The yellow lights are off when mid-travel.

Blinker – The yellow lights flash at approximately 0.5 second intervals when travelling in mid-travel (electric or handwheel operation). When stationary, the lights will remain on.

On/Alarm – The yellow lights are on when mid-travel. If an alarm is active the yellow lights flash alternately at approximately 0.5 second intervals. Refer to 5/7 Alarm LED.

Off/Alarm – The yellow lights are off when mid-travel. If an alarm is active the yellow lights flash alternately at approximately 0.5 second intervals. Refer to 5/7 Alarm LED.

Information regarding the nature of the alarm(s) will be shown at the top of the display.

To change the mid-travel LED Mode,    . The drop down list box will close and the selected mode will be shown.

5/7 Alarm LED

Alarm LED Function will be greyed out unless 4/7 Mid Travel LED is set to On/Alarm or Off/Alarm.





Disabled (default) – The yellow lights do not indicate an active alarm.

Alarms – The yellow lights indicate active alarms.

Service – The yellow lights indicate active service alarms only. A service alarm indicates the actuator requires service due to set duty parameters being met. Refer to Section 5.5.

Service/Alarms – The yellow lights indicate active alarms and active service alarms. A service alarm indicates the actuator requires service due to set duty parameters being met. Refer to Section 5.5.

Information regarding the nature of the alarm(s) will be shown at the top of the display.

To change the Alarm LED Mode,    . The drop down list box will close and the selected mode will be shown.

6/7 LCD / LED Test





The LCD/LED test function operates a test procedure to check all of the local display functions. It will cycle periodically between screen and LED functions to provide visual indication that the display is in fully working order.

Press  to begin the test. The screen will return to the local display menu once the test is complete.

7/7 Language

The language used on the display can be selected.

English (default), French, German and Spanish are available as standard. Other available languages may be downloaded from the Rotork website, loaded into the Setting Tool using Insight 2 and uploaded into the actuator. Visit www.rotork.com

To change the display language,    . The drop down list box will close and the selected language will be active for all screens and pages.

Available for actuators with a build date after December 2013 (12/13).

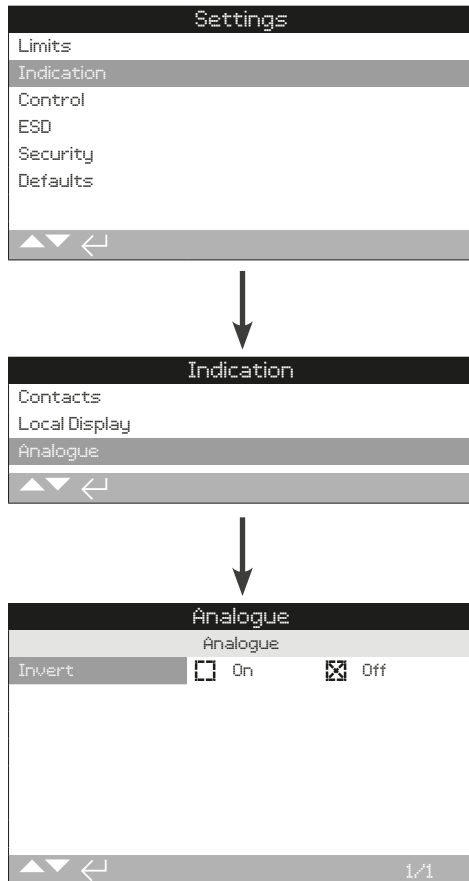

Analogue position indication screen is shown above with its default setting.



Analogue position indication (4-20 mA) is an optional extra, refer to circuit diagram for inclusion. If the option is not fitted the Analogue menu item will not be present in the Indication menu.

The analogue output signal auto ranges to the set limits and cannot be calibrated.

1/1 Invert

Off (default) – 4 mA output at Closed Limit position / 20 mA output at Open Limit position.

On – 4 mA output at Open Limit position / 20 mA output at Closed Limit position.

To change the analogue output mode,  . The checkbox will indicate the selected mode.



Instruction is provided on:

2.3.1 Local control

Settings for vandal resistant build, Setting Tool control, maintained local control, delay control and action on loss of actuator user interface.

2.3.2 Remote control

Settings for control source; hardwired, networks, analogue and partial stroke setup.

2.3.3 Interrupter Timer

The Interrupter Timer is an optional extra, check circuit diagram for inclusion. If it is not enabled it will not be included in the display menu. It is used to control closing and/or opening operating time under both local and remote control.

2.3.4 Shutdown Battery

The Shutdown Battery is an optional extra for IQT actuators. If it is not fitted, it will not be visible within the display menu. The Shutdown Battery provides fail-to-position functionality in the event of mains power loss.

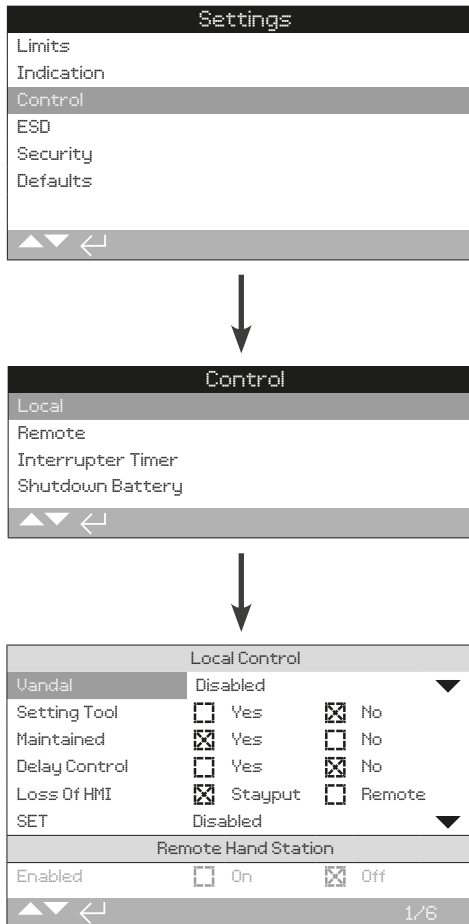

The local control configuration page is shown with the default settings.

1/7 Vandal

Actuators built as vandal resistant type 1 do not have the black and red control selectors fitted. Selection of Local control (using the Setting Tool open, close and stop keys) and Remote control is made using the vandal setting:

Disabled (default) – Actuator is not vandal resistant build and control selectors are present.

Local – Actuator selected for Local control using the Setting Tool (Bluetooth or infrared), refer to 1.1. Infrared local control has a range of approximately 0.25 m (10") and must be in direct line of site. Bluetooth Local control has a range up to approximately 10 m (30 ft) depending on environment.

Remote – Actuator selected for Remote control. Setting Tool control keys are inactive and the actuator responds only to remote control signals.

Switched – This option is available with an external PCB (i.e. DIO), the actuator uses the input to switch the vandal between local and remote.

To change, . The drop down list will close and the selected control mode will be indicated.

2/7 Setting Tool

With control selectors fitted to the actuator, the Setting Tool close, open and stop control keys can be used to operate the actuator:

Yes – Setting Tool control keys active, control is possible only when the red selector is set to Local, refer to 1.1 – using the Setting Tool. Infrared local control has a range of approximately 0.25 m (10") and must be in direct line of site. Bluetooth Local control has a range up to approximately 10 m (30 ft) depending on environment. The black close/open selector remains active.

No (default) – Setting Tool close, open and stop control keys disabled. Local control is by close/open/ stop selectors fitted to the actuator.

To change, . The checkbox will indicate the selected Setting Tool control mode.

3/7 Maintained

Sets the action as a response to local open or close control signals:

Yes (default) – The actuator will self-maintain as a response to a fleeting local open or close control signal. It will run until it receives a stop command, it reaches a travel limit or is reversed – Maintained control.

No – The actuator will run only while an open or close control signal is applied – Push to run local control.

To change, . The checkbox will indicate the selected action.

4/7 Delay Control

If there is a risk of a local close or open control signal being applied due to the selector moving inadvertently or by being hit momentarily, a delay can be set to help prevent an unintended operation:

Yes – A local close or open signal must be held for approximately 2 seconds before the actuator responds.

No (default) – The actuator responds immediately to a local close or open control signal.

To change, . The checkbox will indicate the selected local selector response.

5/7 Loss of HMI

The Human Machine Interface consists of the actuator display and red and black selectors. If for any reason the HMI stops responding, the response of the actuator can be set.

Stayput (default) – The actuator will stayput and alarm using the monitor relay. It will not respond to remote control signals.

Remote – The actuator will alarm using the monitor relay. It will continue to respond to remote control signals.

To change, . The checkbox will indicate the selected HMI failure response.

6/7 SET

For SET enabled actuators only, refer to PUB002-039 for details.

7/7 Remote Hand Station

When fitted, the Remote Hand Station (RHS) can be enabled by this setting.

Off (default) – RHS not activated and the sub-menus will be hidden.

On – RHS enabled and the sub-menus will appear in the main Control menu. Refer to PUB002-059 for full setup.

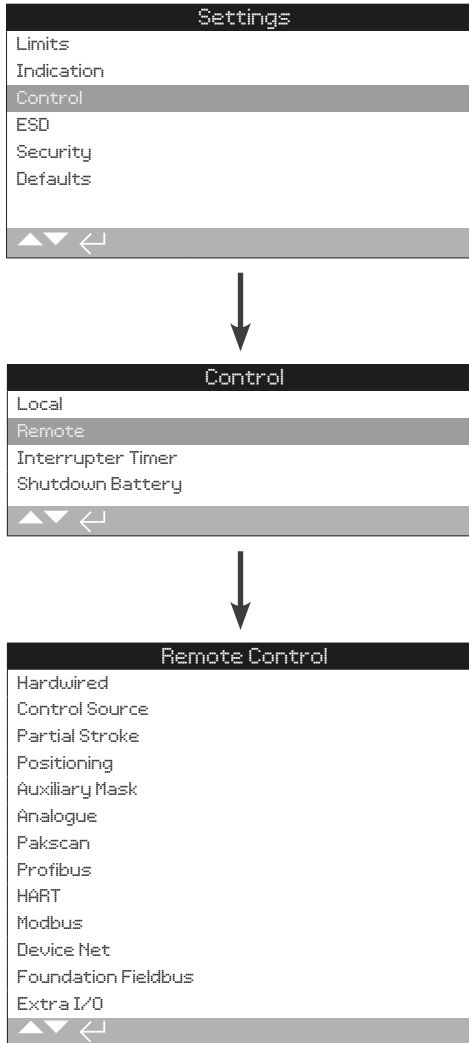

Instruction is provided on the setup of standard hardwired and remote control options.

The Remote Control menu is shown left listing all possible entries. Some menu items shown are optional remote control forms requiring additional hardware to be fitted in the actuator (see table below). **The menu list displayed on the actuator will show only the option(s) fitted.** Options not fitted will not be included in the menu list, check wiring diagram for option inclusion.

The table below lists the available standard and option remote control forms, their type and the section of this manual where instruction is provided.

Remote Control Form	Included as:	Type	Section
Hardwired	Standard	Hardwired	2.3.2-1
Control Source	Standard	Software	2.3.2-2
Partial Stroke	Standard	Hardwired	2.3.2-3
Positioning	Option	See Note	2.3.2-4
Auxiliary Mask	Option	See Note	2.3.2-5
Analogue	Option	Analogue	2.3.2-6
Pakscan	Option	Network	2.3.2-7
Profibus	Option	Network	2.3.2-8
HART	Option	Analogue	2.3.2-9
Modbus	Option	Network	2.3.2-10
Device Net	Option	Network	2.3.2-11
Foundation Fieldbus*	Option	Network	N/A
Extra I/O	Option	Hardwired	2.3.2-12

* When Foundation Fieldbus is fitted it will be included in the remote control menu for information only. The Foundation Fieldbus option is configured remotely over the Fieldbus network and therefore does not have a setup page. Control Source, Positioning and Auxiliary Mask pages will be included to allow associated setting to be made when Foundation Fieldbus is fitted.

Note: When any of the analogue or network remote control options are fitted, Auxiliary Mask and Positioning are automatically included in the remote control menu. These items allow access to settings that are common to all fitted options. See Examples below.

Example 1: For a basic actuator with no control options fitted, the remote control menu is shown below.



Example 2: For an actuator with a remote control option, the remote control menu will automatically display the appropriate items relating to that option. The example below shows the menu for an actuator including the Profibus option with the associated Positioning and Auxiliary Mask items.

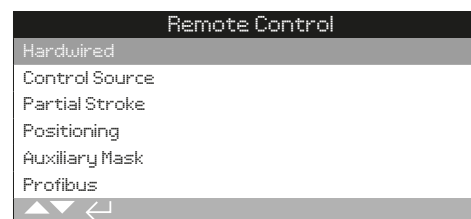

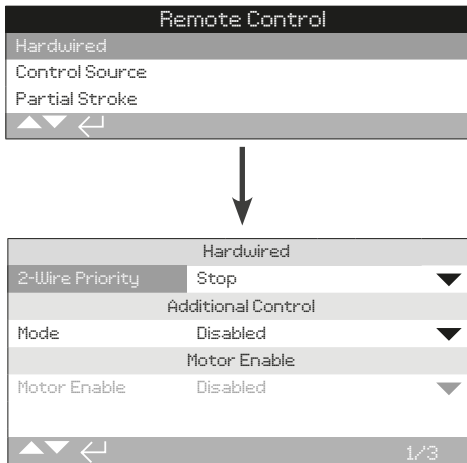

Hardwired Control is a standard feature. The default settings are shown above.





Hardwired Control is a standard remote control form available on all actuators. It allows settings for hardwired 2-wire priority control and interlocks.

1/3 2-Wire Priority

Sets the action the actuator perform when a close and open signal are applied simultaneously. Hardwired remote control form C uses the priority action (open or closed) to set the actuator response when 2 signals are applied. Refer to the wiring diagram and its referenced RWS control diagram.

On applying hardwired close and open signals together, the actuator will:

- Open** – The actuator will move open.
- Stop (default)** – The actuator will not move, or will stop if running.
- Close** – The actuator will move closed.

To change,    . The drop down list will close and the selected 2-wire control mode will be indicated.

2/3 Additional Control

Set the operating mode for the terminals marked as interlocks, refer to wiring diagram. External interlocks can be used to prevent operation of the actuator until a certain process condition is met. An example is a main and bypass valve system. The main valve is interlocked with the bypass valve such that it cannot be opened until the bypass valve is fully open.

Disabled (default) – The interlock inputs are disabled, interlocking is not available.

Interlocks – Open and close interlock inputs become active and provide traditional interlocking functionality. The actuator will not run in local or remote control unless an interlock signal is applied for the required operating direction. If only one interlock is required by the site process, the other interlock must be linked out to always permit operation.

Conditional – Open and close interlock inputs become active and provide permissive control for remote command signals. Remote control is conditional on two signals being applied simultaneously (e.g. close command and close interlock) and therefore integrity of operation due to spurious control signals is increased. Local control remains available.

Partial Stroke – Partial stroke testing demonstrates the operational integrity of the valve and actuator by moving them for a set portion of stroke. A remote "partial stroke" hardwired signal applied to the open interlock input is used to initiate a partial stroke test. For setting the partial stroke test parameters, refer to 2.3.2-3. When set to partial stroke, the closed interlock input is disabled. Partial stroke initiated via a network command (with a network option fitted), does not require the interlocks to be configured for partial stroke.

To change the settings use    . The drop down list will close and the selected interlock mode will be indicated.

3/3 Motor Enable

Sets the remote control maintain function when the motor enable feature is used. When using motor enable, the maintain line on terminal 34 becomes the permissive input.

Disabled (default) – Maintain function is controlled by applying a signal to terminal 34.

Push to Run – Remote controls are push to run. On removal of the remote open or close command, movement will stop.

Maintained – Remote controls are self maintained so only a pulse is required. Removal of the remote open or close signal will not stop operations. To stop movement, you must remove the motor enabled signal.

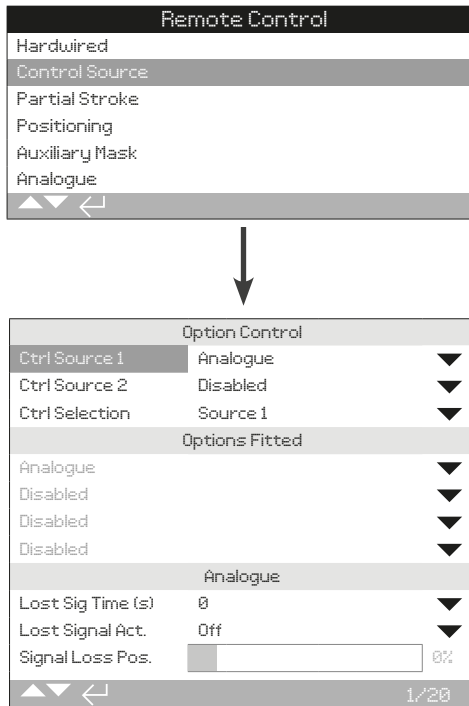

The Control Source setting page shown above is an example of an actuator with the Analogue remote control option.

The actuator display will indicate fitted options.

Refer to wiring diagram for options fitted.

Introduction

In addition to standard hardwired control, the actuator can have up to two remote control options fitted. For most remote control systems employed by end-users, only one control option is used.

For control systems using Analogue control only or where Analogue and Network (such as Modbus) control is used, control (Hardwired/Analogue or Analogue/ Network) can be switched by the user using the Manual/Auto input available with the analogue option and the settings made in Control Source. When Analogue and Network options are fitted and Analogue is switched to control, the Network option cannot control the actuator but will continue to report actuator status.

The control source will be set by Rotork to the defaults required for the option(s) fitted. Refer to Table: Control Source Settings.

For analogue control, if both Manual (hardwired control inputs) and Auto (analogue control) is to be used, the control selection will require re-setting. If only analogue control is required, the default settings for Control Source will be correct. Refer also to 2.3.2-6.

The control source is used to:

- Control Source 1/Source 2 - Associate fitted control option(s) to a source of control (source 1 or source 2).
- Control Selection - Set which control source (1 or 2) has priority when Manual/Auto input is used to switch between Analogue and Network option sources.
- Lost Signal - Determines the actuator response to a lost analogue signal or network communication.

Table: Control Source Settings

Options Control					
Settings	Hardwired (no options)	Analogue Only	Analogue and Hardwired	Network Only	Analogue and Network
Ctrl Source 1	Disabled	Analogue	Analogue	Network	Analogue
Ctrl Source 2	Disabled	Disabled	Disabled	Disabled	Network
Ctrl Selection	Hardwired	Source 1	Hardwired / Source 1	Source 1	Source 1 / Source 2
Options Fitted					
	Disabled	Analogue	Analogue	Network	Network
	Disabled	Disabled	Disabled	Disabled	Analogue
	Disabled	Disabled	Disabled	Disabled	Disabled
	Disabled	Disabled	Disabled	Disabled	Disabled

KEY: For "Network", display will indicate the fitted option(s): Pakscan/Profibus/Modbus/Foundation Fieldbus (FF)/HART/DeviceNet.

2.3.2-2 Control – Remote – Control Source *continued*

1/20 Control Source 1

Control Source 1 will be set by Rotork for the fitted remote Analogue or Network control option(s). Refer to Table: Control Source Settings.

2/20 Control Source 2





Control Source 2 will be set by Rotork for the fitted remote Analogue or Network control option(s). Refer to Table: Control Source Settings.

3/20 Ctrl Selection

Control Selection is used to select the control source and if required, for Analogue option or Analogue with Network options, allow hardwired switching between sources using the Manual/Auto input.





Disabled – All remote control disabled. The actuator can only be operated using the local controls.

Hardwired – Remote control by hardwired inputs only. This setting is the default for actuators with no option cards fitted.

If a Network option is fitted but is not required for control,     to select **Hardwired**.

Source1 – Control by the option listed for Control Source 1. If Control Source 1 is a Network option, control will be via its auxiliary mask inputs, refer to 2.3.2-5.

Hardwired / Source1 – Control available only when Analogue option is fitted. This mode enables the user to select between control by hardwired inputs or source 1 (Analogue) control by applying or removing a signal to the Manual/Auto input, refer to wiring diagram. Manual will enable hardwired control and Auto will enable Source1 control.

If an Analogue option is fitted and Manual/Auto switching is required,     to select **Hardwired/Source 1**.

Source 1 / Source 2 – Control by Analogue and a Network option only. This mode enables the user to select between Source 1 (Analogue) and Source 2 (Network) control, by applying or removing a signal to the Manual/Auto input available with the Analogue option, refer to wiring diagram. Manual will enable source 2 and Auto will enable source 1, refer to 2.3.2-6.

4/19 to 7/19 Options Fitted

Not editable. Factory set for the control options fitted. Up to 4 options can be fitted and will be indicated in the list. Unused allocations will be set to Disabled.

If a control option is fitted after manufacture, the allocation will be set to the fitted option type by Rotork Service. Where the user upgrades an actuator to include a new control option using a kit supplied by Rotork, this must be set before the control mode settings can be made. Contact Rotork for access.

8/20 to 19/20 Lost Signal





Sets the actuator response for when the analogue signal or Network communications of the control source are lost.

There are 3 settings for determining the actuator response on loss of signal and these are common for all option types fitted. Each group of 3 will be headed with the applicable option type - example Analogue. For actuators including one control option, settings 8/20 to 10/20 will be available and settings 11/20 to 20/20 will be greyed out. For 2 options fitted, 8/20 to 13/20 will be available and so on up to 4 options. This instruction is therefore common for as many options as are fitted.

8/19 Lost Signal Time

Sets the amount of time in seconds that a signal must be lost before the set lost signal action is performed. Range 0 to 65 seconds:

For the analogue option, time must be set to 0 seconds.

To change,    . **The time set after which the lost signal action will be implemented and indicated.**

9/19 Lost Signal Action

Sets the action performed when the signal is lost:





Off (default) – The lost signal feature is disabled. An actuator with Analogue control will run to the set low signal position. An actuator with Network Control will stay at its current position when communication is lost.

Stayput – If the actuator is not moving it will Stayput, if it is moving it will Stop.

Close – The actuator will run to the Close Limit.

Open – The actuator will run to the Open Limit.





Position – The actuator will run to the mid-travel position set for Signal Loss Position, refer to 10/19.

To change,    . **The drop down list will close and the selected action will be indicated.**

10/19 Lost Signal Position

When the lost signal action is set to Position the actuator will run to the mid-travel position set. Range is 0% (Closed Limit) to 100% (Open Limit). This control should be used if a lost signal position in mid-travel is required.

Whenever the actuator is running under positioning mode, the parameters in the Positioning menu will apply. Refer to 2.3.2-4.

To change,    . **The slider control will indicate the mid-travel position the actuator will move to when the control/network signal is lost.**

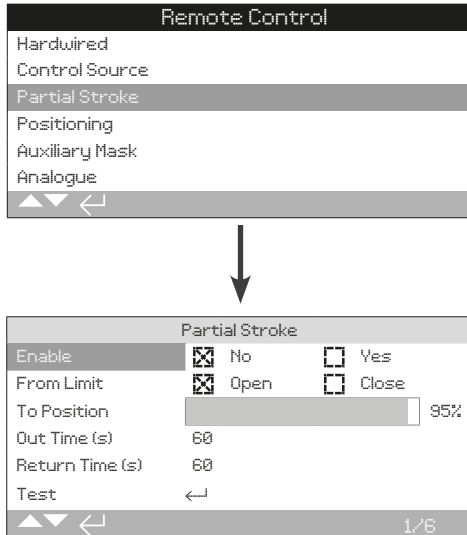

Partial Stroke is a standard feature. The default settings are shown above.

Partial stroke testing is used to demonstrate the operational integrity of the valve and actuator by moving over a set portion of valve stroke. In addition, partial stroking may be used to exercise infrequently operated valves to help keep them mechanically free. Partial stroke test can only be initiated when the actuator is at the set From Limit position.

A partial stroke test may be initiated by a remote partial stroke signal applied to the open interlock*, a network command (network option fitted) or using the test control on the partial stroke page.

*Interlocks must be set to partial stroke, refer to 2.3.2-1.





Partial stroke test results (torque and pass/ failure status) are captured by the data log.

Partial stroke operation, pass and failure can be indicated by the S contacts, refer to 2.2.1.

1/6 Enable

No (default) – Partial stroking testing is disabled

Yes – Partial stroke testing is enabled.





To change,     . The checkbox will indicate partial stroke test status.

2/6 From Limit

Selects the start/finish limit position for the partial stroke test.

Open (default) – The partial stroke test will start from the Open Limit position, move close to the position set for 3/6 To Position and then return to the Open Limit position.

Close – The partial stroke test will start from the Closed limit position, move open to the position set for 3/6 To Position and then return to the Close Limit position.





To change,    . The checkbox will indicate partial stroke start/finish position.

3/6 To Position

Range 0% (closed) to 97% Open

Selects the intermediate position for the partial stroke test.

Sets the position in valve stroke to where the actuator will move when a partial stroke test is initiated. For example a test starting at Open Limit with a To Position of 70% set, will move from Open Limit to 70% open and then return to the Open Limit. A minimum of 3% travel is required to adequately perform the partial stroke test.





To change,    . The slider control will indicate the position the actuator will move to for the partial stroke test.

4/6 - 5/6 Out Time - Return Time

Range 0 to 3600 seconds.

For IQ actuators, out time and return time must be set to the same value. They are used to ensure that the partial stroke test is completed in a quantified period of time. Alarms can be set to indicate a failure in meeting the set time, indicating a valve problem.

Measure or calculate the time to complete the set partial stroke test. Add 10% to this value then half it. The resulting time should be entered into both Out Time and Return Time.

To change,    . The set partial stroke out/return time will be indicated.

6/6 Test

To initiate a partial stroke test using the Setting Tool, the actuator must be set to Local control using the red selector and at the limit position set for 2/6 From Limit.

To initiate a partial stroke test, . The partial stroke test will be initiated as set.

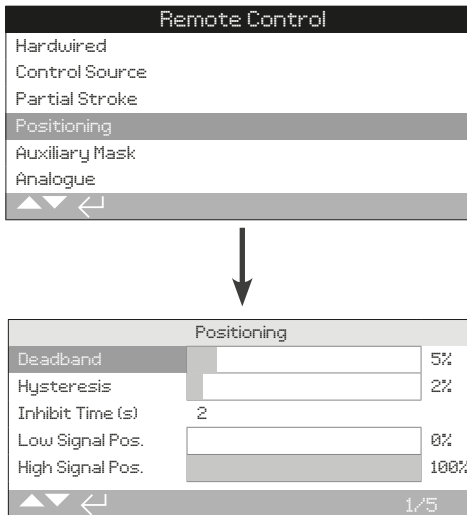

The Positioning option settings page with its default settings is shown above.

Applicable for Analogue and HART control options and for all Network control options where positioning control is required. Settings are used to tune the actuator positioning response.



- Deadband and Hysteresis are combined to set positioning accuracy.
- Inhibit Time is used to set a dwell in the actuators response.
- Low/High Signal Position sets the range of the valve stroke where positioning is required.

1/5 Deadband

Range 0% - 25.5%. Default setting: 5%.

Affects positioning accuracy as a response to the process control system desired value (DV) signal position. A smaller deadband increases accuracy, however the widest deadband should be set while maintaining good control in order to protect the mechanical valve from excessive wear and/or to keep the actuator within its electrical rating.

Deadband setting should be combined with 2/5 Hysteresis setting. The actuator will run towards the DV position until the actual position is within the set deadband minus the hysteresis setting. This has the effect of the actuator stopping nearer to the DV position. The actuator will not restart unless it overshoots and runs outside the deadband or a new command places the new desired position outside the deadband. Refer to figure 2.3-1.



To change,    . The slider control will indicate the deadband setting.

2/5 Hysteresis

Range 0% - 25.5%. Default setting: 2%.

Affects positioning accuracy as a response to the process control system desired value (DV) signal position. A larger Hysteresis setting will increase accuracy but the value set must not be greater than that set for Deadband.





Hysteresis setting should be combined with 1/5 Deadband setting. The actuator will run towards the DV position until the actual position is within the set deadband minus the hysteresis setting. This has the effect of the actuator stopping nearer to the DV position. The actuator will not restart unless it overshoots and runs outside the deadband or a new command places the new desired position outside the deadband. Refer to figure 2.3-1.

To change,    . The slider control will indicate the hysteresis setting.

3/5 Inhibit Time

Range 0 – 255 seconds. Default setting: 5 seconds.

Sets a delay after the actuator stops as a result of reaching a position consistent with a new DV position. For the period set, the actuator will not respond to a change in DV. Inhibit time is used to prevent unwanted operation as a result of a rapidly oscillating or fluctuating DV signal or to slow actuator response in order to protect the mechanical valve from excessive wear and/or maintain actuator within its electrical rating.

To change,    . The time set will be indicated.



4/5 Low Signal Pos

Range 0% to 100% open positions.

Used to set the position the actuator will move to when the low analogue signal is applied for Analogue control or for a 0% position command for Network options. Normally this will be set at Closed Limit position (0%), unless positioning is required over a reduced portion of full valve travel, for example, to prevent full closure where valve throttling is required.

To change, . The slider control will indicate the position the actuator will move to when the low signal is applied.

5/5 High Signal Pos

Range 0% to 100% open positions.

Used to set the position the actuator will move to when the High analogue signal is applied for Analogue control or for a 100% position command for Network options. Normally this will be set at Open Limit position (100%), unless positioning is required over a reduced portion of full valve travel, for example, to increase positioning resolution for a butterfly valve where positioning is required from Closed Limit position to 60% open position.

To change, . The slider control will indicate the position the actuator will move to when the high signal is applied.

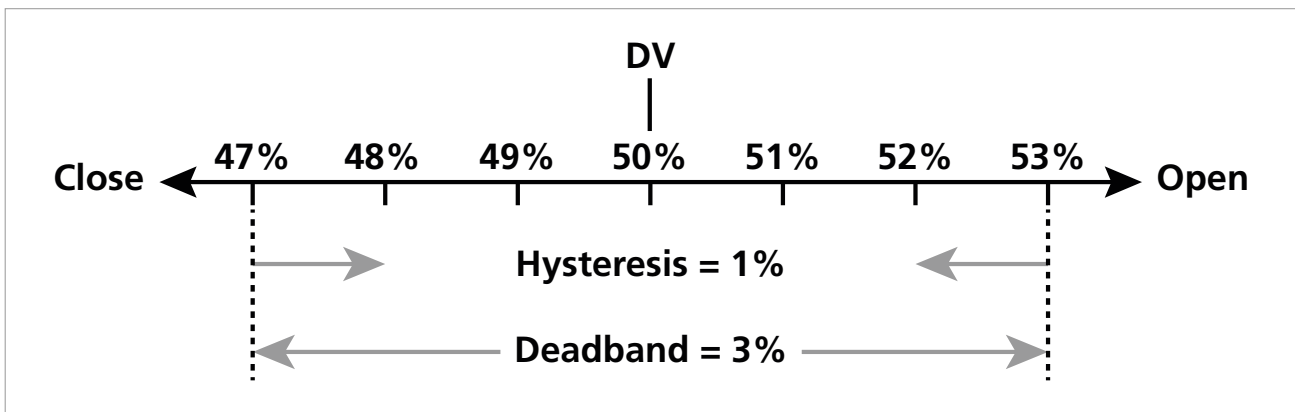
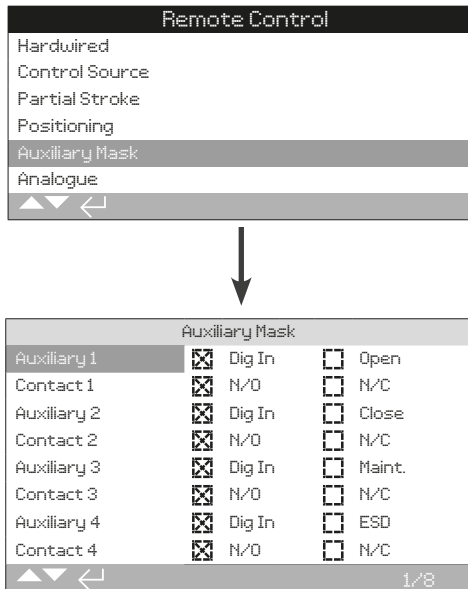

Figure 2.3-1 Example of Hysteresis and Deadband

Example: An actuator set with a 3% deadband and a 1% hysteresis and a control system new Desired Value (DV) of 50% will come to rest between 48% and 53% when moving from a position less than 47%, and between 52% and 47% when moving from a position greater than 53%.

The Deadband setting will be determined by the accuracy of control required and valve overrun. Overrun is a factor of valve and actuator inertia dependent on mass, speed, valve stiffness and friction



The Auxiliary Mask settings page is shown above with default settings visible.

Introduction

When a Network option is fitted (Pakscan/Profibus/Modbus/Foundation Fieldbus or HART) a facility to accept 4 Auxiliary inputs is available. Auxiliary inputs can be set as supplementary control for the actuator (open, close, stop/maintain or ESD) or as digital indication inputs whose status is reported over the option network. It is also possible to have a combination of both supplementary remote control and digital inputs to provide, for example, open and close control as well as a high and low tank level alarm indication from external level transducers.

Auxiliary inputs are in addition to the standard control and feedback features incorporated into a Network option. Auxiliary inputs are connected to the standard Open, Close, Stop/maintain and ESD inputs. Refer to wiring diagram.

NOTE: If an Analogue option and a Network option are fitted and hardwired ESD control is required (Auxiliary 4 set to ESD), ensure Auxiliary contact 4 setup is matched to the ESD configuration when signal setting. Refer to 2.4.

The Auxiliary Mask page allows the user to setup the 4 Auxiliary inputs as supplementary control, indication or a combination of both. Each Auxiliary input can be set for the type of contact connected. Refer to Auxiliary input setup.

Auxiliary Input Setup

Input	Auxiliary 1	Auxiliary 2	Auxiliary 3	Auxiliary 4
Control	Open	Close	Stop/Maintain	ESD
Indication	Digital Input	Digital Input	Digital Input	Digital Input
Contact type	Contact 1	Contact 2	Contact 3	Contact 4
Normally Open	N/O	N/O	N/O	N/O
Normally Closed	N/C	N/C	N/C	N/C

A normally open contact is considered to be in the active state when the contact is closed. A normally closed contact is considered to be in the active state when the contact is open.

Using Auxiliary 1 and Contact 1 as an example:

1/8 Auxiliary 1

Refer to Auxiliary input setup.

Dig in (default) – Network option will report digital input status: 1 or 0

Open – Hardwired open command signal is required. Use Auxiliary 2 to 4 for close, stop/maintain and ESD.

To change the settings use    . The checkbox will indicate the set Auxiliary 1 input function.

2/8 Contact 1

Refer to Auxiliary input setup.

N/O (default) – A normally open contact is used to derive input.

N/C – A normally closed contact is used to derive input.

To change the settings use    . The checkbox will indicate the set Contact 1 input type.

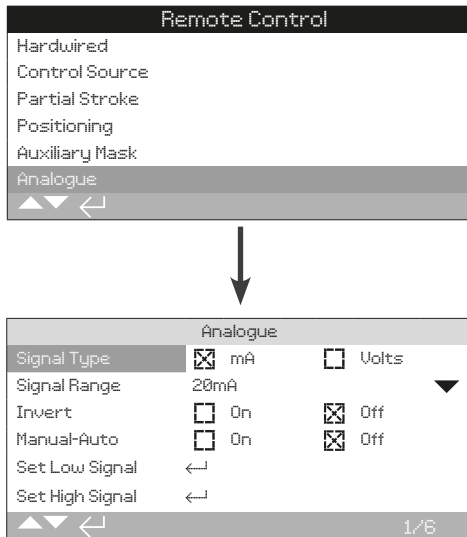

The Analogue option settings page is shown above with its default settings. Analogue is a control option.



The Analogue menu item and its associated settings page will only be shown when the Analogue option is fitted. Refer to wiring diagram. The Analogue option setting page allows the option to be set for the applied signal type and range. Signal low and high values can also be calibrated.

For Analogue option; deadband, hysteresis and positioning settings, refer to 2.3.2-4.

1/6 Signal Type



mA (default) – Set for current (mA) Analogue control signal.

Volts – Set for voltage Analogue control signal.

To change,   . The checkbox will indicate the set Analogue signal type.

2/6 Signal Range



Available ranges: 5 mA, 10 mA or 20 mA (default) or 5 V, 10 V or 20 V range for voltage control. For Analogue signal using a 4 mA to 20 mA range, set 20 mA.

To change,   . The drop down list will close and the selected range will be indicated.

3/6 Invert

Off (default) – Low Analogue signal will move the actuator in the close direction.

On - High Analogue signal will move the actuator in the close direction.

To change,   . The checkbox will indicate the set Analogue signal action.

4/6 Manual-Auto

With the Analogue control option it is possible to have Manual/Auto control by a user supplied remote switch selection:

	Analogue Option Fitted	Analogue and Network Options fitted
Manual	Hardwired	Network
Auto	Analogue	Analogue

When Analogue and Network options are fitted and Auto is selected, the Network option fitted will continue to report actuator status.

Hardwired ESD is available in both Manual and Auto. When applied, ESD will override all other control signals. Refer to 2.4 ESD.

For Manual Auto control, refer to wiring diagram and referenced RWS diagram.

OFF (default) – Manual/Auto control is not used. Actuator will be controlled by the Analogue signal. Where a Network option is also fitted, the Network option will report actuator status only.

On – Actuator can be controlled by hardwired contacts or the Network (as applicable) or by the Analogue signal.

To change the settings use,   . The checkbox will indicate the set Manual/Auto mode.

5/6 Set Low Signal

The actuator must be calibrated to the Low Analogue signal value. By measuring this signal it will then be able to control the actuator by moving it to the Set Low Signal position, refer to 2.3.2-4.

APPLY THE LOW ANALOGUE SIGNAL and select . The signal will be measured and set as the Low signal position value.

6/6 Set High Signal

The actuator must be calibrated to the High Analogue signal value. By measuring this signal it will then be able to control the actuator by moving it to the Set High Signal position, refer to 2.3.2-4.

APPLY THE HIGH ANALOGUE SIGNAL and select . The signal will be measured and set as the High signal position value.

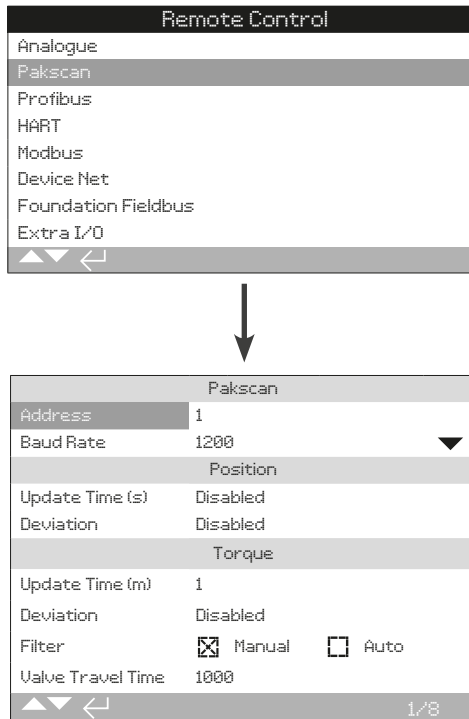

The Pakscan Control option settings page is shown above with its default settings. Pakscan is a control option, refer to wiring diagram.

Depending on the Pakscan control scheme, other related settings may be required, refer also to:

2.3.2-4 Positioning

2.3.2-5 Auxiliary Mask

1/8 Address

The Pakscan Field Control Unit option must be allocated a unique loop node address. Changes made to the address will take effect immediately. The range of address is 1 – 240.

To change, . The set address will be indicated.

2/8 Baud rate

The actuator Pakscan Field Control Unit option must be set to the loop baud rate. For a Pakscan 2-wire control loop the selected baud rate must be common in the master station and all the field units included in the loop. Changes made to baud rate will take effect immediately. The baud rate is selectable using the drop down list box are 110, 300, 600, 1200, 2400.

To change, . The drop down list will close and the selected baud rate will be indicated.

Position

3/8 Update Time(s)

Range 0 (Disabled) to 255 seconds.

Set when mid-travel positioning control is required. Update Time in seconds is the set period for updating the master station with position data. Refer also to 4/8 Deviation. The valve position will be reported at time intervals equating to the set Update Time. If the FCU updates on deviation whilst the valve is moving then the update time should be set to approximately 10 times the loop scan time. If the actuator is not used for mid-travel positioning (i.e. isolating duty), then the Update Time should be turned off by setting it to zero (Disabled).

To change, . The set Position Update time in seconds will be indicated.

4/8 Deviation (%)

Range 1% to 99%. Setting below 1% will indicate Disabled.

Set when mid-travel positioning control is required. Deviation is the set amount of change that has to occur before the position data is reported to the master station. Whilst the valve is in motion, reports about its position will be made each time the position changes by more than the Deviation setting. The recommended value is 5% where positioning data is required. If the actuator is not used for mid-travel positioning (i.e. isolating duty), then the Deviation should be turned off by setting it to zero (Disabled).

To change, . The set Position Deviation % will be indicated.



Torque

5/8 Update Time (m)

Range 5 to 255 minutes. Setting below 5 will indicate Disabled.

Torque update time (minutes) value is refreshed from a stationary actuator. If torque data is not required then its update time should be disabled.

To change, . The set Torque Update time in minutes will be indicated.

6/8 Deviation

Range 1% to 99%. Setting below 1% will indicate Disabled.

Set for the amount of change in actuator measured torque that has to occur before torque data is reported to the master station. During valve travel, torque reporting will be made each time the torque changes by more than the Deviation setting. Where continuous torque data is required the recommended value is 5%. If torque data is not being used then the deviation should be set to Disabled.

To change, . The set Torque Deviation % will be indicated.

7/8 Filter

Set to enable or disable auto reporting of the historical torque logs.

Auto - The Pakscan option will automatically report the 6 historical torque logs for each direction once the actuator has stopped at a limit. The historical log will contain the instantaneous value of torque for both closing and opening torque logs.

Manual – The historical torque logs are not automatically updated. Historical logs are read on demand using a master station command. In Manual, the historical logs will contain the averaged (or filtered) torque logs i.e. the data from the actuator average torque logs.

To change, . The checkbox will indicate the set Torque Log Filter mode.

8/8 Valve Travel Time

Range 0 to 18000 seconds.

Valve travel Time should be set to a value 10% greater than the actual valve travel stroke time (i.e. open to close). If the valve travel time is exceeded, an alarm will be raised via the Pakscan Network.

To change, . The set Valve Travel Time will be indicated.

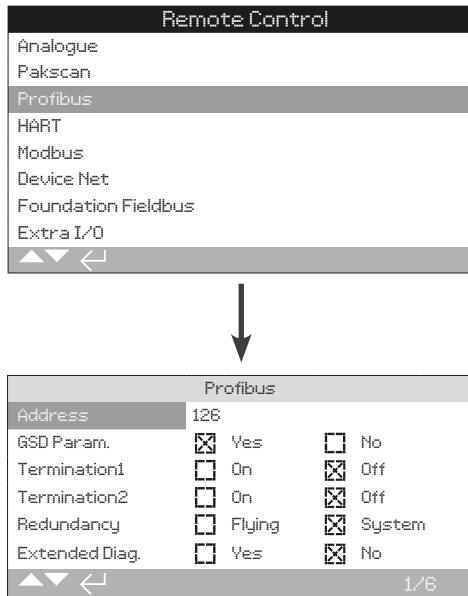

The Profibus Control option settings page is shown above with its default settings. Profibus is a control option and is available in single or dual versions, refer to wiring diagram.

Depending on the Profibus control scheme, other related settings may be required, refer also to:

2.3.2-4 Positioning

2.3.2-5 Auxiliary Mask

1/6 Address

The actuator Profibus module must be allocated a unique address in the Profibus system. Changes made to the address will take effect immediately. The range of address is 1 – 126 (default 126). Refer also to 5/6 Redundancy.

To change, . The set address will be indicated.

2/6 GSD Parameter

If the user parameterisation data is to be setup using FDT, EDDL or the actuators menu, setting this menu item to No will ensure that the user parameterisation data sent to the Profibus card during the parameterisation of the Profibus network with the GSD file will be ignored. The settings previously made will not be overwritten. As default this is Yes to ensure that the Profibus card will be parameterised by the GSD user parameterisation data.

Yes (default) – Parameterisation by GSD file is enabled.

No – Parameterisation by GSD file is disabled.

3/6 - 4/6 Termination 1 - Termination 2

Profibus networks require active termination at each end of the highway. Profibus option has active termination (2 sets for dual) built in, which can be switched in or out of the circuit.

Off (default) - Termination resistors switched out.

On – Termination resistors switched in.

To change, . The checkbox will indicate the set termination mode.

5/6 Redundancy

Used for dual Profibus option (redundant) only. Refer to wiring diagram.

System (default) - System redundancy means that there are 2 completely separate Profibus highways in the network system and that each highway is connected to one of the Profibus channels. In this mode the address of both Profibus channels are identical.

Flying - Flying redundancy means that there is 1 highway that is connected to both channels, in this mode the addresses of the channels must be different to avoid both channels responding to the same message. In flying redundancy channel 2 address will be channel 1 address plus 64.

If flying redundancy is used, the address for 1/6 must not be set higher than 62.

To change, . The checkbox will indicate the set redundancy.

6/6 Extended Diagnostics

Used for dual Profibus option (redundant) only. Refer to wiring diagram.

The slave redundancy specification from the PNO describes extended diagnostics that are available in the redundant card. These messages describe, for example, the state of the backup channel. Diagnostics messages can be turned on and off depending on the capabilities of the PLC to which the module is connected.

No (default) - Diagnostic messages turned off.

Yes - Diagnostic messaging turned on.

To change, . The checkbox will indicate the set extended diagnostic mode.

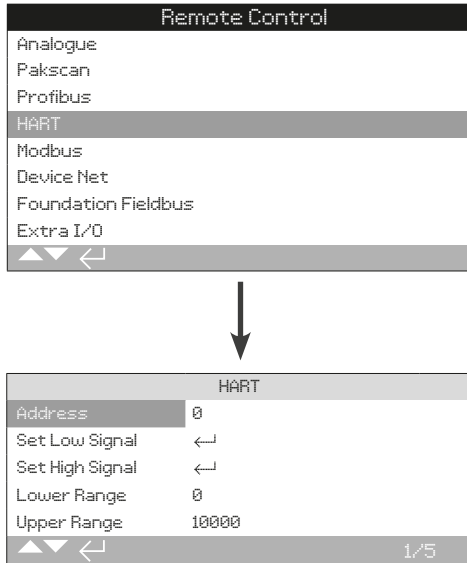

The HART Control option settings page is shown above with its default settings. HART is a control option, refer to wiring diagram.

For HART control option, other related settings are required, refer also to:

2.3.2-4 Positioning

2.3.2-5 Auxiliary Mask

1/5 Address

The HART option must be allocated a unique address in the HART system. Changes made to this parameter will take effect immediately. The range of address is 0 – 63 (default 0).

To change, . The set address will be indicated.

2/5 Set Low Signal

The actuator must be calibrated to the Low analogue signal value. By measuring this signal it will then be able to control the actuator by moving it to the Set Low Signal position, refer to 2.3.2-4 Positioning.

APPLY THE LOW ANALOGUE SIGNAL and select  the signal will be measured and used to send the actuator to the set Low signal position.

3/5 Set High Signal

The actuator must be calibrated to the High analogue signal value. By measuring this signal it will then be able to control the actuator by moving it to the Set High Signal position, refer to 2.3.2-4 Positioning.

APPLY THE HIGH ANALOGUE SIGNAL and select  the signal will be measured and used to send the actuator to the set High signal position.

4/5 Lower range

Range 0% to 100% open positions.

Used to set the position the actuator will move to when the low analogue signal is applied for HART control. Normally this will be set at Closed Limit position (0%), unless positioning is required over a reduced portion of full valve travel, for example, to prevent full closure where valve throttling is required.

To change, . The slider control will indicate the position the actuator will move to when the HART low signal is applied.

5/5 Upper Range

Range 0% to 100% open positions.

Used to set the position the actuator will move to when the High analogue signal is applied for HART control. Normally this will be set at Open Limit position (100%), unless positioning is required over a reduced portion of full valve travel, for example, to increase positioning resolution for a butterfly valve where positioning is required from Closed Limit position to 60% open position.

To change, . The slider control will indicate the position the actuator will move to when the HART high signal is applied.

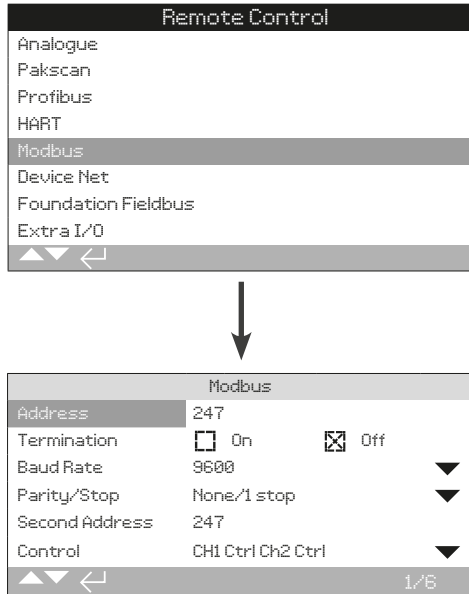





The Modbus Control option settings page is shown above with its default settings. Modbus is a control option and is available in single or dual channel versions, refer to wiring diagram.

Depending on the Modbus control scheme, other related settings may be required, refer also to:

- 2.3.2-4 Positioning
- 2.3.2-5 Auxiliary Mask

1/6 Address

The Modbus option must be allocated a unique address in the system to which it is attached. Changes made to this parameter will take effect immediately. The address range is 1 – 247 (default 247).





To change,    . The set address will be indicated.

2/6 Termination

Modbus networks require termination resistors at each end of the highway. The Modbus option has a passive (120 Ohm) termination resistor (2 for dual) built in, which can be switched in or out of the circuit.





Off (default) - Termination resistor(s) switched out.

On – Termination resistor(s) switched in. In a dual channel Modbus option, when On is selected the termination resistors will be switched in for both channels.

To change,    . The checkbox will indicate the set termination mode.





3/6 Baud Rate

The Modbus option must be set to the RS485 highway baud rate. Changes made to this parameter will take effect immediately. The baud rates selectable using the drop down box are 110, 300, 600, 1200, 2400, 4800, 9600, 19200, 38400, 57600, 115200.

To change,    . The drop down list will close and the selected baud rate will be indicated.

4/6 Parity/Stop





Where Modbus parity bit detection is used, the module must be set with the same parity settings as the host. The choices of parity are None, Even, Odd. This item also allows selection for the number of stop bits as 1 or 2. The drop down box requires selection of the parity and stop bits together.

To change,    . The drop down list will close and the selected parity and stop bit will be indicated.

5/6 Second Address

Used for dual Modbus option (redundant) only. Refer to wiring diagram.

A dual Modbus card has 2 channels available for connection to separate or the same highway(s). The second channel address is set up with this setting. It may be identical or different to the first channel depending on the requirement of the system.

To change,    . The set second address will be indicated.

6/6 Control

Configure the Modbus channels for control, monitoring or off.

Ch1 Ctrl Ch2 Ctrl – Channel 1 and channel 2 are controlling the actuator.

Ch1 Ctrl Ch2 On – Channel 1 is controlling the actuator and channel 2 is monitoring only.

Ch2 Ctrl Ch1 On – Channel 2 is controlling the actuator and channel 1 is monitoring only.

Ch1 On – Channel 1 is controlling the actuator and channel 2 is off.



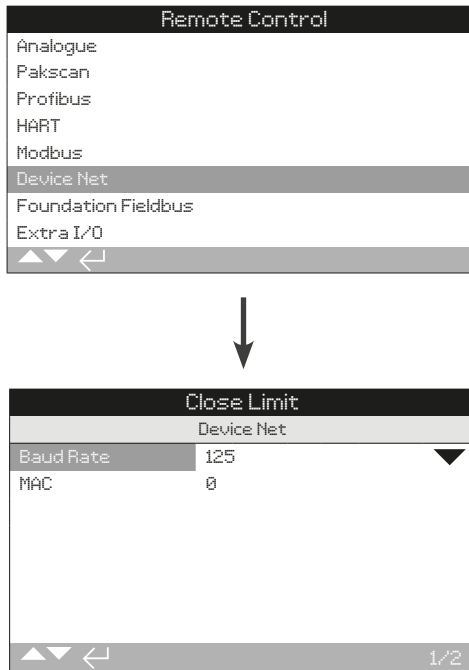

Ch2 On – Channel 2 is controlling the actuator and channel 1 is off.



The Device Net settings screen is shown above. Device Net is a control and feedback option, refer to wiring diagram.





1/2 Baud Rate

Configure the Device Net communication baud rate to 125, 250 or 500. This setting must match the connected network speed.

To change,    . The drop down list will close and indicate the set baud rate.

2/2 MAC (Address)

Configure the actuator MAC for communication on the network. The MAC setting can be 0 – 63 and must be a unique address for the connected network.

To change,    . The set MAC address will be shown.

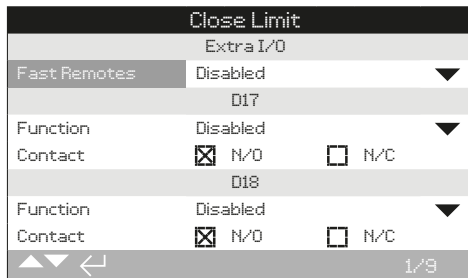
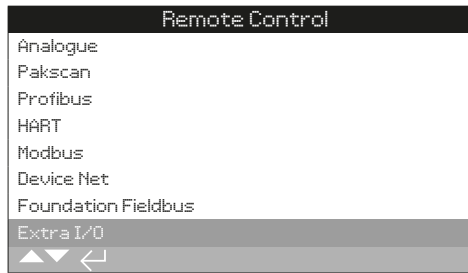

The DIO adds additional digital inputs and outputs to the actuator.

Fast Remotes

Fast remotes are for modulating applications (24 VDC signals only)

Disabled

Enabled

Functions

Below is a list of functions available for each I/O:

Disabled

Remote Open

Remote Closed

Remote Maintain

Remote ESD

Open Interlock

Close Interlock

Net Disable

Partial Stroke

HandAuto

VelanReset

ConditionalOpen

ConditionalClose

Contacts

These are the default positions for the contacts which the user can set

N/O – Normally Open Contact

N/C – Normally Closed Contact

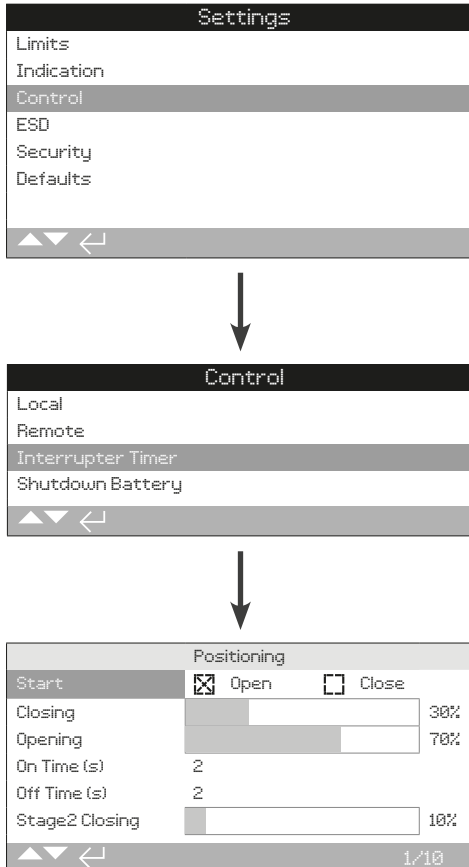

The Interrupter Timer is an optional extra. When enabled, it will be included in the control menu.

To enable the Interrupter Timer contact Rotork.

Introduction

The Interrupter Timer allows the valve operating time to be increased. This is used, for example, to prevent hydraulic shock ("water hammer") when closing or to prevent surges when opening a valve. The Interrupter Timer is active in both local and remote control. It may be overridden during an ESD operation, refer to 2.4

The IQ is a single speed machine so to increase the valve operating time the timer stops and starts the actuator automatically – timed operation. The timer can be set to operate over all, or a portion of the closing and/or opening strokes and across two stages for increased control.

1/10 Start

Timed operation start position. Applies to stage 1 and stage 2 timers.

Close (Default) – Timed operation to and from the Closed Limit. The Interrupter Timer will start timed operation, in the close direction, at the position set for Closing (2/10, 6/10). It will stop timed operation, in the open direction, at the position set for Opening (3/10, 7/10).

Open – Timed operation to and from the Open Limit. The Interrupter Timer will start timed operation, in the open direction, at the position set for Opening (3/10, 7/10). It will stop timed operation, in the close direction, at the position set for Closing (2/10, 6/10).

To change, . The checkbox will indicate the selected Interrupter Timer start limit.

PLEASE NOTE the shaded area of the slider control for Closing and Opening will be the timed section. If timed operation is no longer required, Closing (2/10, 6/10) and Opening (3/10, 7/10) positions should both be set to 0% or 100% depending on the Start (1/10) setting value.

2/10 Closing

The position where the Interrupter Timer will start/stop stage 1 timed operation in the close direction. If timed operation is not required in the close direction (actuator runs at normal speed), set to 0% (1/10 = Close) or 100% (1/10 = Open).

To change, . The slider will indicate the configured start/stop position.

3/10 Opening

The position where the Interrupter Timer will start/stop stage 1 timed operation in the open direction. If timed operation is not required in the open direction (actuator runs at normal speed), set to 0% (1/10 = Close) or 100% (1/10 = Open).

To change, . The slider will indicate the configured start/stop position.

4/10 On Time (s)

Set the actuator run time during stage 1 timed operation. Stage 1 timed operation is active in the closing direction from 2/10 to 6/10 and in the opening direction from 3/10 to 7/10. Range 2 to 100 seconds.

To change, . The set On time will be indicated.

5/10 Off Time (s)

Set the actuator pause time during stage 1 timed operation. Stage 1 timed operation is active in the closing direction from 2/10 to 6/10 and in the opening direction from 3/10 to 7/10. Range 2 to 3,600 seconds.

To change, . The set Off time will be indicated.

WARNING! To minimise actuator wear, it is advisable to limit the number of start/stops set with the Interrupter Timer function. Using longer durations for On and Off times can achieve the specified valve operating time while reducing the number of starts required to achieve it.

6/10 Stage2 Closing

The position where the Interrupter Timer will start/stop stage 2 timed operation in the close direction. If stage 2 timed operation is not required in the close direction (actuator runs at stage 1 speed), set to 0% (1/10 = Close) or 100% (1/10 = Open).

To change, . The slider will indicate the configured start/stop position.

2.3.3 Control – Interrupter Timer *continued*

7/10 Stage2 Opening

The position where the Interrupter Timer will start/stop stage 2 timed operation in the open direction. If stage 2 timed operation is not required in the open direction (actuator runs at stage 1 speed), set to 0% (1/10 = Close) or 100% (1/10 = Open).

To change, . The slider will indicate the configured start/stop position.

8/10 S2 On Time (s)

Set the actuator run time during stage 2 timed operation. Stage 2 timed operation is active in the closing direction from 6/10 to 1/10 limit position and in the opening direction from 7/10 to 1/10 limit position.

To change, . The set On time will be indicated.

9/10 S2 Off Time (s)

Set the actuator pause time during stage 2 timed operation. Stage 2 timed operation is active in the closing direction from 6/10 to 1/10 limit position and in the opening direction from 7/10 to 1/10 limit position.

To change, . The set Off time will be indicated.

WARNING! To minimise actuator wear, it is advisable to limit the number of start/stops set with the Interrupter Timer function. Using longer durations for On and Off times can achieve the specified valve operating time while reducing the number of starts required to achieve it.

10/10 Effective speed

Non-editable. Automatically indicates the effective speed of the actuator over the timed portion(s) for the set on and off times.

Example: To prevent hydraulic shock, the valve must be closed at a moderate speed from 50% open to 25% open, then a slower speed from 25% open to the Closed Limit. Timed operation is not required at all when opening, the actuator will run at normal speed for the complete opening valve stroke.

Correct settings are as follows:

1/10 Start = Close

Stage 1	Stage 2
2/10 Closing = 50%	6/10 Closing = 25%
3/10 Opening = 0%	7/10 Opening = 0%
4/10 On Time = 5 seconds	8/10 On Time = 2 seconds
5/10 Off Time = 5 seconds	9/10 Off Time = 8 seconds

Stage 1 operation has an effective speed of 50%.
Stage 2 operation has an effective speed of 20%.
Overall effective speed of the timed portions is 35%.

2.3.4 Control – Shutdown Battery

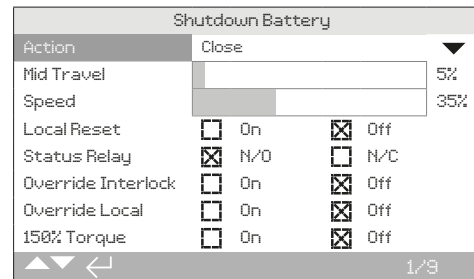

1/9 Action

The shutdown battery can be configured for one of the following actions. The actuator will power off after the shutdown action is complete (excludes UPS mode).

UPS mode – actuator will continue to respond to control commands until battery capacity is depleted.

ESD – actuator will perform the configured ESD action. Refer to section 2.4.

Open – actuator will operate to the open limit on loss of mains power.

Mid Position – actuator will travel to the preconfigured intermediate position (2/9).

Close – actuator will operate to the close limit on loss of mains power.

Stayput – actuator will stop and stay in position. Any control commands will be ignored.

To change, . The drop down list will close and the selected shutdown action will be indicated.

2/9 Mid Travel

Set the stop position for the Mid Position shutdown action. Only applicable for Mid Position shutdown action (1/9).

0 - 100% – configurable for any position at 1% increments.

To change, . The slider will indicate the configured travel position.



3/9 Speed

Set the operating speed for the shutdown action. Only applicable to ESD, Open, Mid Position or Close shutdown action.

Disabled – shutdown action will perform at the normal actuator operating speed. Refer to section 2.1.

25 - 100% – shutdown action will operate at the configured speed. Configurable at 1% increments. 100% is the actuator rated speed.

To change, . The slider will indicate the configured shutdown action speed.

4/9 Local Reset

The local reset requires an operator to interact with the actuator local controls after a power loss event.

On – actuator will not be operational until the local control selector is moved to STOP after a power loss.

Off – actuator will be fully operational after a power loss.

To change, . The checkbox will indicate the local reset setting.

5/9 Status Relay

Set the contact form for the status relay. The relay indicates remaining battery charge status.

N/O – Normally Open contact form. Relay will make if charge is high enough for one full stroke.

N/C – Normally Closed contact form. Relay will break if charge is high enough for one full stroke.

To change, . The checkbox will indicate the status relay setting.

6/9 Override Interlock

The shutdown action will only perform if certain interlock conditions are met. Override interlock allows the shutdown action to perform when an interlock signal is active.

On – the shutdown action will perform regardless of interlock status.

Off – the shutdown action will not perform if interlocks are active and inhibiting operation.

To change, . The checkbox will indicate the override interlock setting.

7/9 Override Local

The shutdown action will only perform if the actuator is in a suitable operating mode. Override local allows the shutdown action to perform when the actuator is selected to LOCAL.

On – the shutdown action will perform in REMOTE and LOCAL.

Off – the shutdown action will only perform in REMOTE.

To change, . The checkbox will indicate the override local setting.

8/9 Override Timer

The shutdown action will operate subject to the interrupter timer operating characteristics.

On – the shutdown action will ignore the interrupter timer settings.

Off – the shutdown action will conform to the interrupter timer settings. Refer to section 2.3.3.

To change, . The checkbox will indicate the override timer setting.

9/9 150% Torque

Set the torque protection level during the shutdown action. Only applicable to ESD, Open, Mid Position or Close shutdown action.

On – the shutdown action will perform with up to 150% torque.

Off – the shutdown action will perform with the set torque limit. Refer to section 2.1.

To change, . The checkbox will indicate the 150% torque setting.

WARNING: ESD shutdown action may override STOP if configured to override stop in the ESD setting menu. Always apply caution when working on or near IQT actuators with the Shutdown Battery option.

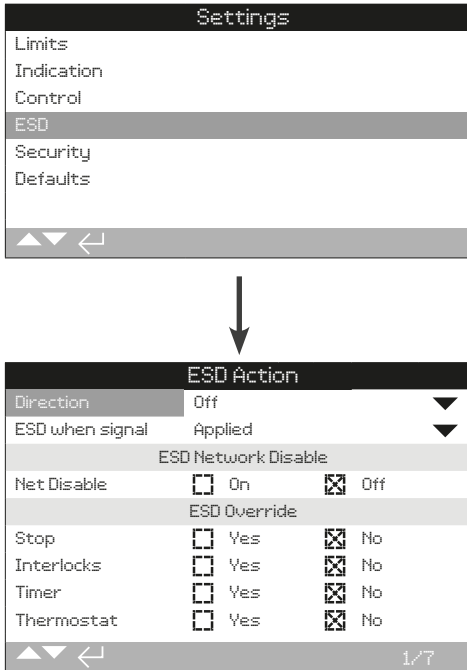

Emergency Shut Down (ESD) is a standard feature.

Refer to actuator wiring diagram.

Control under an ESD control signal has higher priority than local or remote open/closed signals. For ESD, the control signal must be maintained for the duration of the ESD action required.

ESD control will operate under both the Local and Remote control selection. ESD can also be set to operate an actuator selected to Local Stop, refer to ESD Override - 4/7.

ESD Action

1/7 Direction

Close – Under ESD control the actuator will close. It will not respond to local or remote open or closed signals.

Stayput (default) – Under ESD control the actuator will Stop if running or Stayput in its current position. It will not respond to local or remote open or closed signals.

Open – Under ESD control the actuator will open. It will not respond to local or remote open or closed signals.

Off – ESD input is disabled. ESD is not available

To change, . The drop down list will close and the selected ESD action will be indicated.

2/7 ESD when signal

Applied (default) – ESD will be active when the control signal is applied to the ESD input – Normally Open (N/O) contact making.

Removed – ESD will be active when the signal is removed from the ESD input - Normally Closed (N/C) contact breaking.

Note: If the analogue option and a Network option are fitted and hardwired ESD control is required, ensure the ESD when signal set matches that set for Auxiliary contact 4. Refer to 2.3.2-5.

ESD Network Disable

3/7 Net Disable

When a Network option is fitted, refer to 2.3.2, the ESD input can be set to disable Network control. The Network option fitted will report status only.

Off (default) – The ESD input is set for ESD control.

On – The ESD input is set for Network disable.

To change, . The checkbox will indicate ESD/ Network Disable status.

ESD Override

ESD can be set to override Local Stop selection, Active Interlocks, Interrupter Timer and Motor Thermostats.

4/7 Stop

ESD override Local Stop selection.

No (default) – ESD action is not available when the actuator is selected to stop using the local/stop/remote selector.

Yes – ESD action is available when the actuator is selected to stop on the local/stop/remote selector.

⚠ WARNING: In this mode, when under ESD control, setting Stop on the red selector will not prevent operation under ESD control. The valve and actuator can operate. Consideration should be given to providing warning signs and control system information. In all circumstances, Stop selection cannot be considered as a safety lockout – always isolate the electrical supply to the actuator during valve or actuator maintenance.

To change, . The checkbox will indicate ESD override Local Stop status.



5/7 Interlocks

External interlocks can be used to prevent operation of the actuator until a certain process condition is met. Refer to 2.3.2-1 If interlocks are being used, ESD can be set to override them.

No (default) – ESD action cannot override active interlocks.

Yes – ESD action will override active interlocks.

⚠ WARNING: In this mode, when under ESD control, the process or safety interlocks may be overridden. Consideration should be given to providing warning signs and control system information. In all circumstances, active interlocks cannot be considered as a safety lockout – always isolate the electrical supply to the actuator during valve or actuator maintenance.

To change, . The checkbox will indicate ESD override interlock status.

6/7 Timer

ESD will override the Interrupter Timer (if enabled).

The Interrupter Timer option allows the valve operating time to be increased. This is used, for example, to prevent hydraulic shock (water hammer) when closing or to prevent surges when opening a valve. The Interrupter Timer is active in both local and remote control, refer to 2.3.3.

No (default) – ESD action cannot override the Interrupter Timer. Under ESD control, the timer will remain active and the valve operating time, as controlled by the Interrupter Timer, is set.

Yes – ESD overrides the Interrupter Timer. Under ESD control, the timer will be overridden and the actuator will run continuously to the set ESD position at normal speed.

⚠ WARNING: In this mode when under ESD control, process conditions requiring slow operation may be compromised. Consideration should be given to providing warning signs and control system information.

To change, . The checkbox will indicate ESD override Interrupter Timer status.

7/7 Thermostat

The IQ motor includes two embedded thermostats. Should the duty cycle of the actuator be exceeded and the motor temperature rises to that of the thermostat trip temperature, the motor will be de-energised and the actuator will stop. On cooling, the thermostats will automatically reset and the actuator can be returned to operation.

⚠ WARNING - Actuators certified for use in Hazardous Areas. If the thermostats are bypassed during ESD, hazardous area certification is invalid. Users must carry out their own risk assessment. Due to this requirement, an internal physical link must also be set to bypass thermostats. Setting 7/7 alone to Yes will not bypass the thermostats. Contact Rotork.

ESD action can be set to override tripped thermostats providing an internal physical link is also set:

No (default) – ESD action cannot override the thermostats.

Yes – ESD overrides tripped thermostats. Under ESD control, should the motor temperature rise and trip the thermostats, ESD operation will continue.

To change, . The checkbox will indicate ESD override thermostats status.

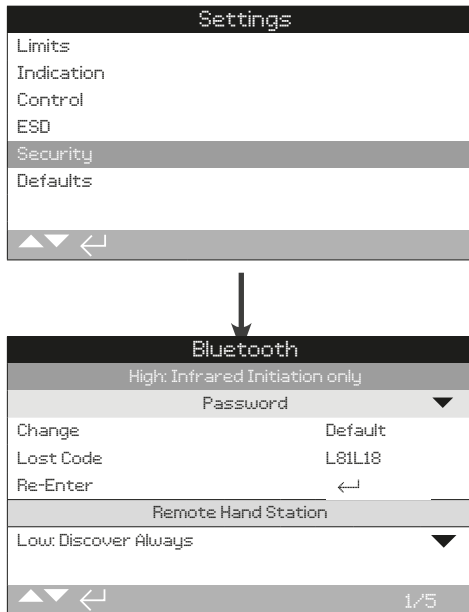

Sets Bluetooth communication and Password security levels. The default settings are shown above.

1/5 Bluetooth





Low: Discover always – The actuator is available for Bluetooth communication using a PC running Insight 2 at all times. This setting provides convenient connection when Insight 2 is used. Communication with the Bluetooth® Setting Tool Pro is available.

Medium: Discover in Local and Stop – The actuator is available for Bluetooth communication using a PC running Insight 2 when it is selected to Local or Stop using the red selector. Connection is unavailable in Remote. Communication with the Bluetooth® Setting Tool Pro is available.

High: Infrared Initiation only (default) – The actuator is not available for Bluetooth communication using a PC running Insight 2. Communication with the Bluetooth® Setting Tool Pro is available using the quick connect method. Refer to 1.2.

Very High: Disabled. Infrared only – All Bluetooth communication is disabled. Communication is by infrared commands from the Bluetooth® Setting Tool Pro only. Refer to 1.2.

If requested, the user required Bluetooth security level can be set and made non-editable by Rotork. Contact Rotork.

To change,    . The drop down list will close and indicate the set Bluetooth security level.

2/5 Change



The default password is **ROTORK** (User). Change (2/5) will indicate: Default.

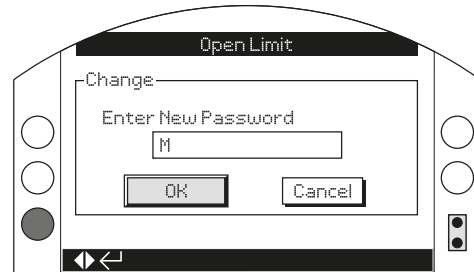

This can be changed to a new password selected by the user.

To set a user selected Password press . The Change password display will be shown.



Enter user selected Password:

Use  to highlight new password entry box and press .

Use   to scroll through alphanumerical values to display required character.

Use  to move to next character.

Use  to delete the previous character.

Use  when selected password is complete.

Navigate to the OK button using . Press .

The user selected password is now active. Refer to 1.3.

Change (2/5) will indicate User Defined.

The lost code (3/5) characters will change to reflect the new password.

3/5 Lost Code

Non editable. Lost Code is used if a user password has been set and then lost or forgotten.

Contact Rotork quoting the code as read from the display. After caller verification, Rotork can then provide the user set password.

4/5 Re-Enter

The Re-Enter password setting allows an operator to change permission level during the same communication session (such as entering a high level password).

Enter the different password, refer to 1.3.

Once correctly entered, access to high level settings as indicated in this manual will be made available.

Some settings are only available using a high level password. Contact Rotork for the user high level password.

5/5 Remote Hand Station

The Bluetooth security for the Remote Hand Station (if connected) is configurable to the same settings as the actuator Bluetooth security. The settings can be different to meet operating requirements. Refer to Bluetooth (1/5).

To change,    . The drop down list will close and indicate the set Remote Hand Station Bluetooth security.

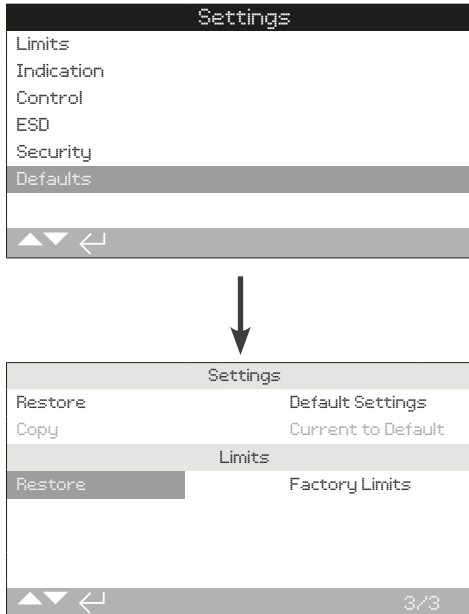

Allows default settings and factory set limits to be restored.

Settings



1/3 Restore

All IQ functions are configured to Rotork default settings before despatch. If requested at time of order, alternative user specified settings will be set.

When valve maker and site commissioning takes place, any settings entered will overwrite the factory default settings and will be the current settings used in operation along with the remaining unadjusted defaults.

Should difficulty be encountered during commissioning the default settings can be restored, returning the actuator configuration to its default settings.

Standard default settings are indicated in this manual.

To restore the default settings, press .
A warning will appear, press  to continue.



 All settings must then be checked/set as required for valve operation and process control/indication.

2/3 Copy

High level access only. Refer to 2.5 Security.

Once satisfactorily commissioned and tested, the current settings can be saved as the new defaults.

If Rotork commission the actuator, on completion and agreement, current settings will be saved as defaults.



After entering the high level password, press .
A warning will appear, press  to continue.

All current settings will be saved as the default settings.

Limits

3/3 Restore

This setting will restore the factory set limit positions and position the actuator at 50% open. Factory limits: 25 output turns (or quarter-turn for IQT) between Closed and Open Limit positions.

To restore the default limits, press .
A warning will appear, press  to continue.

 Closed and Open Limits must be reset to the valve. Refer to 2.1

3. Status

Status screens on the IQ range display are provided to assist diagnostics. The displayed information is live data taken from the main data log processor and can be used to view control signals, alarms, movement and internal diagnostic data.

Refer to section 1.2 for connecting to the actuator. Once connected, navigate to the main icon menu and select the Status icon:

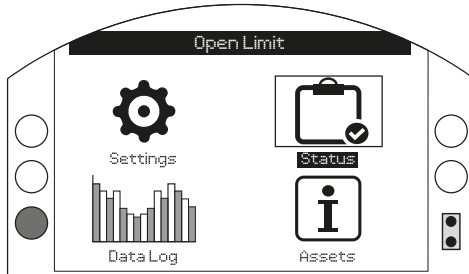

3. Status menu

Page

3.1	Control	39
3.1.1	Local	40
3.1.2	Remote Hardwired	41
3.1.3	Remote Source 1	42
3.1.4	Remote Source 2	42
3.1.5	Shutdown Battery	43
3.2	Alarms	44
3.3	Movement	45
3.4	Indication	46
3.5	Diagnostics	47

3.1 Status – Control

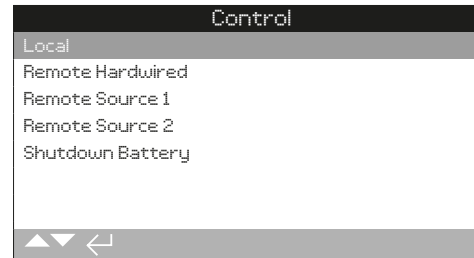
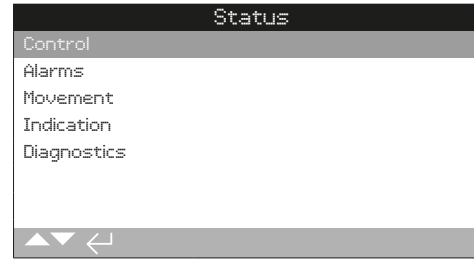



3.1.1 Control – Local

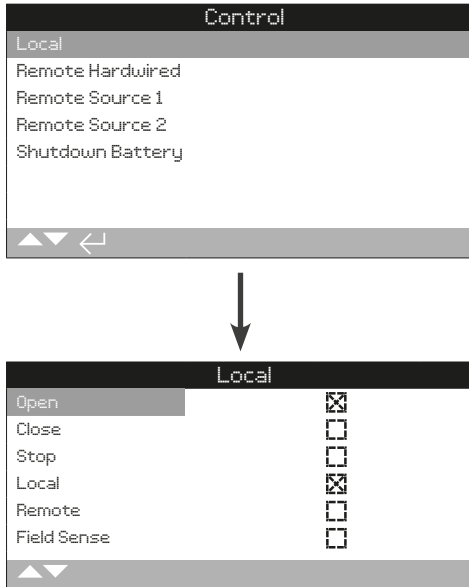

Local Control Status

View the signal status for each of the local selector inputs. As the local controls are operated, the corresponding checkbox will show an active signal. Confirming healthy local selector operation is useful when diagnosing fault conditions.

Movement may occur during testing of the local control selectors. To prevent movement, set the operating mode to STOP.

1/6 Open

Displays the current Local Open signal status. A check indicates the local Open/Close selector is in the Open position and the command is recognised.

2/6 Close

Displays the current Local Close signal status. A check indicates the local Open/Close selector is in the Close position and the command is recognised.

3/6 Stop

Displays the current Local Stop signal status. A check indicates the Local/Stop/Remote mode selector is in the Stop position and the command is recognised.

In Stop mode, the actuator will not move. All local and remote control signals will be ignored except for ESD if configured to override Stop, refer to 2.4.

4/6 Local

Displays the current Local signal status. A check indicates the Local/Stop/Remote mode selector is in the Local position and the command is recognised.

In Local mode, the Open/Close selector will operate the actuator in the selected direction. Remote control signals will be ignored except for ESD.

ESD will still operate the actuator in Local mode.

5/6 Remote

Displays the current Remote signal status. A check indicates the Local/Stop/Remote mode selector is in the Remote position and the command is recognised.

In Remote mode, the actuator will respond to signals from the hardwired inputs, control source 1 or control source 2. Local control signals will be ignored.

6/6 Field Sense

Field Sense is activated whenever an excessive magnetic field is detected in addition to the control selector magnets. This could indicate a high magnetic field in the near vicinity, which may affect local control operation.

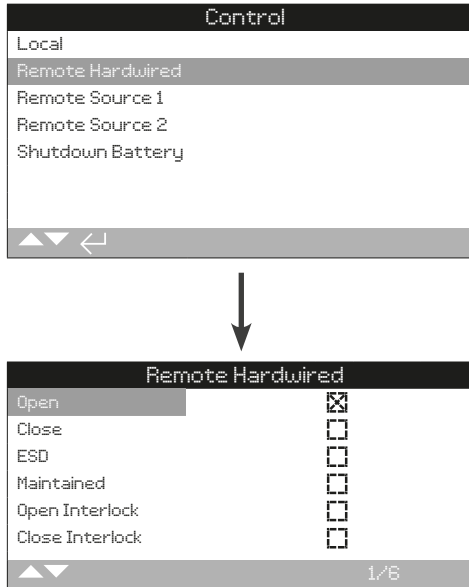

5/6 Open Interlock

Displays the current remote hardwired Open Interlock signal status. A check indicates a signal is applied to the Open Interlock hardwired input and the command is recognised.

When Interlocks are enabled, the actuator will prevent operation in the Open direction unless there is a signal applied to the Open Interlock hardwired input. Refer to 2.3.2-1.

6/6 Close Interlock

Displays the current Remote Hardwired Close Interlock signal status. A check indicates a signal is applied to the Close Interlock hardwired input and the command is recognised.

When Interlocks are enabled, the actuator will prevent operation in the Close direction unless there is a signal applied to the Close Interlock hardwired input. Refer to 2.3.2-1.

Remote Hardwired Status

View the signal status for each of the remote hardwired inputs. As remote signals are applied, the corresponding checkbox will show an active signal.

Movement may occur during testing of the remote hardwired inputs. To prevent movement, set the operating mode to STOP.

1/6 Open

Displays the current remote hardwired Open signal status. A check indicates a signal is applied to the Open hardwired input and the command is recognised.

2/6 Close

Displays the current remote hardwired Close signal status. A check indicates a signal is applied to the Close hardwired input and the command is recognised.

3/6 ESD

Displays the current remote hardwired ESD signal status. A check indicates a signal is applied to the ESD hardwired input and the command is recognised.

4/6 Maintained

Displays the current remote hardwired Maintained signal status. A check indicates a signal is applied to the Maintain hardwired input and the command is recognised.

When a Maintain signal is present, the actuator will self-maintain a fleeting Open or Close control signal. Operation will continue until the Maintain signal is removed, a limit position is reached or a command is issued to reverse direction.



3.1.3 Control – Remote Source 1

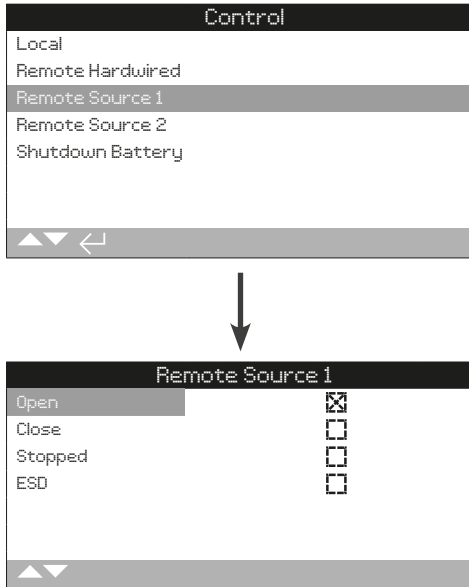

Remote Source 1 Status

View the signal status for Remote Source 1 inputs, refer to 2.3.2-2. As remote signals are applied, the corresponding checkbox will show an active signal.

Only digital remote control options will report a control status. Analogue control must be checked using the Positioner home screen, refer to 2.2.2.

Movement may occur during testing of the remote hardwired inputs. To prevent movement, set the operating mode to STOP.

1/4 Open

Displays the remote Source 1 Open signal status. A check indicates an Open Source 1 signal is present and the command is recognised.

2/4 Close

Displays the remote Source 1 Close signal status. A check indicates a Close Source 1 signal is present and the command is recognised.

3/4 Stopped

Displays the remote Source 1 Stopped signal status. A check indicates a Stop Source 1 signal is present and the command is recognised.

4/4 ESD

Displays the remote Source 1 ESD signal status. A check indicates an ESD Source 1 signal is present and the command is recognised.

3.1.4 Control – Remote Source 2

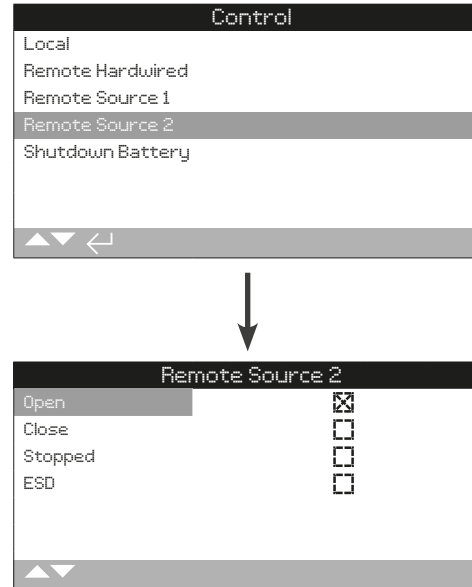

Remote Source 2 Status

View the signal status for Remote Source 2 inputs, refer to 2.3.2-2. As remote signals are applied, the corresponding checkbox will show an active signal.

Only digital remote control options will report a control status. Analogue control must be checked using the Positioner home screen, refer to 2.2.2.

Movement may occur during testing of the remote hardwired inputs. To prevent movement, set the operating mode to STOP.

1/4 Open

Displays the remote Source 2 Open signal status. A check indicates an Open Source 2 signal is present and the command is recognised.

2/4 Close

Displays the remote Source 2 Close signal status. A check indicates a Close Source 2 signal is present and the command is recognised.

3/4 Stopped

Displays the remote Source 2 Stopped signal status. A check indicates a Stop Source 2 signal is present and the command is recognised.

4/4 ESD

Displays the remote Source 2 ESD signal status. A check indicates an ESD Source 2 signal is present and the command is recognised.

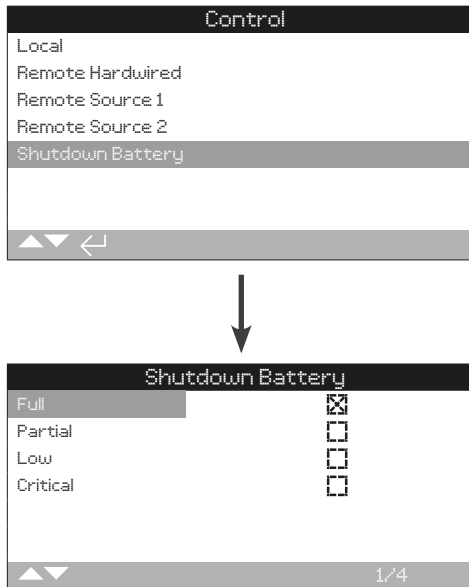

Shutdown Battery Status

This screen displays the charge status of the shutdown battery. The checkbox indicates the active state. Only one state should be active at a time.

1/4 Full

The shutdown battery is fully charged. Full is the expected status while mains power is supplied to the actuator.

2/4 Partial

The shutdown battery is partially charged. Partial should only be present during charging or discharging.

3/4 Low

The shutdown battery has low charge but still enough to perform the configured shutdown action. Low should only be present during charging or discharging.

4/4 Critical

The shutdown battery has critical charge and can no longer perform the configured shutdown action. The actuator will go to sleep if the battery status is critical and mains power is not present.



3.2 Status – Alarms

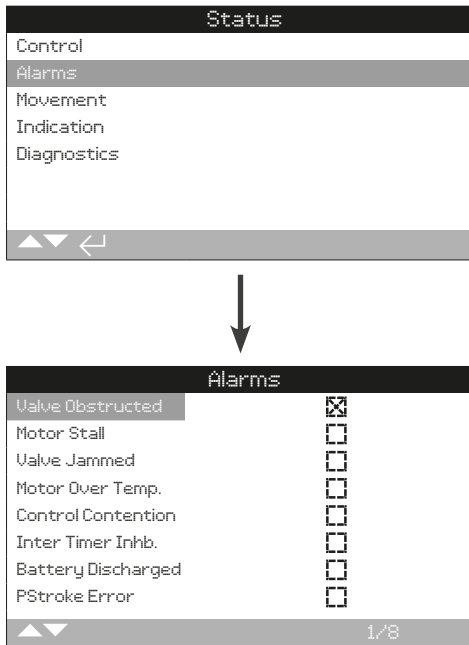

6/8 Inter Timer Inhb.

Displays the Interrupter Timer Inhibit alarm status. When active, this alarm indicates that the Interrupter Timer is actively inhibiting actuator movement.

The Interrupter Timer is used to increase the valve operating time, the timer stops and starts the actuator automatically. The timer can be set to operate over all, or a portion of the closing and/or opening strokes.

7/8 Battery Discharged

Displays the Battery Discharged alarm status. When active, this alarm indicates that the battery is fully discharged and needs to be replaced.

8/8 PStroke Error

Displays the Partial Stroke Error alarm status. When active, this alarm indicates that the partial stroke was unable to be completed in the specified time.

Actuator Alarms

This screen displays the current status of the actuator alarms; the checkbox indicates that the alarm is currently active.

To scroll through this information use .

1/8 Valve Obstructed

Displays the Valve Obstruction alarm status. When active, this alarm indicates that the valve is obstructed or has reached the torque limit set. Check that the valve is free of any obstruction and is operating correctly.

2/8 Motor Stall

Displays the Motor Stall alarm status. When active, this alarm indicates that the actuator has received a valid command, but has not detected any movement within 5 seconds.

3/8 Valve Jammed

Displays the Valve Jammed alarm status. When active, this alarm indicates that the valve has jammed in either the open or closed position. Check valve operation by hand.

4/8 Motor Over Temp.

Displays the Motor Over Temperature alarm status. When active, this alarm indicates that the motor is over temperature and the thermostat has tripped. Check that operating conditions are within specification.

5/8 Control Contention

Displays the Control Contention alarm status. When active, this alarm indicates that more than one control signal is being received. In this event the actuator will remain in position or stop if already travelling.

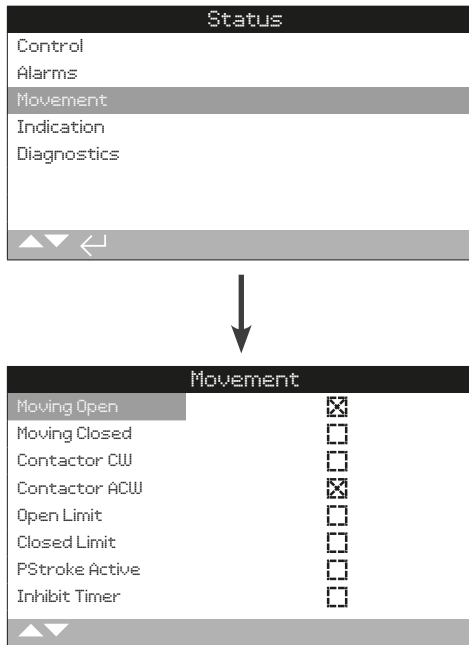

Movement status

This screen displays the current movement status of the actuator. The checkbox indicates that the status is active.

To scroll through this information use .

1/8 Moving Open

Displays the actuator Moving Open status. When active, this status indicates that the actuator is moving open.

2/8 Moving Closed

Displays the actuator Moving Closed status. When active, this status indicates that the actuator is moving closed.

3/8 Contactor CW

Displays the Clockwise Contactor energised status. When active, this status indicates that the clockwise contactor is energised.

4/8 Contactor ACW

Displays the Anticlockwise Contactor energised status. When active, this status indicates that the anticlockwise contactor is energised.

5/8 Open Limit

Displays the Open Limit status. When active, this status indicates that the actuator is at the open limit.

6/8 Closed Limit

Displays the Closed Limit status. When active, this status indicates that the actuator is at the closed limit.

7/8 PStroke Active

Displays the Partial Stroke status. When active, this status indicates that the actuator is carrying out partial stroke movements.

Partial Stroking is used to demonstrate the operational integrity of the valve and actuator by moving over a set portion of valve stroke. In addition, partial stroking may be used to exercise infrequently operated valves to help keep them mechanically free.

8/8 Inhibit Timer

Displays the Inhibit Timer status. When active, this status indicates that the inhibit timer is counting to the set time. Range 0-255 seconds, default 5 seconds.

The Inhibit Timer sets a delay after the actuator stops as a result of reaching a position consistent with a new desired value position. For the period set, the actuator will not respond to a change in the desired value. The inhibit timer is used to prevent unwanted operation as a result of rapidly oscillating or fluctuating desired position signal, or to slow actuator response in order to protect the mechanical valve from excessive wear and/or maintain actuator within its electrical rating. Refer to 2.3.2-4.



3.4 Status – Indication

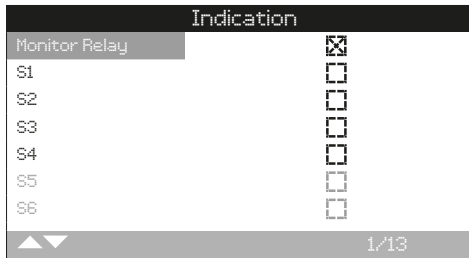
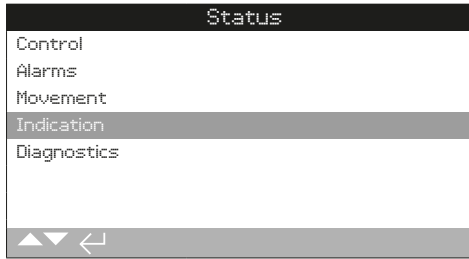

Indication status

This screen displays the indication relays statuses. The checkbox indicates that the relay is energised.

The Monitor Relay and relays S1-S4 are provided as standard, relays S5-S8 and relays S9-S12 are available options that are greyed out if the options are not present.

To scroll through this information use

1/13 Monitor Relay

Displays the Monitor Relay status. A checked checkbox shows the relay is active, whilst an unchecked checkbox represents inactive.

When the monitor relay is used in availability mode; an inactive relay status indicates that the actuator is set to remote control, there are no detected internal failures and the actuator is powered. An active relay status indicates the actuator is not available for remote control.

When the monitor relay is used in fault mode; an inactive relay status indicates that there are no detected internal failures and the actuator is powered. An active relay status indicates the actuator has a fault present and the actuator is not available for remote control.

For each relay function, please refer to 2.2.1.

2/13 S1

Displays the S1 relay status. When active, this indicates that relay S1 is energised.

3/13 S2

Displays the S2 relay status. When active, this indicates that relay S2 is energised.

4/13 S3

Displays the S3 relay status. When active, this indicates that relay S3 is energised.

5/13 S4

Displays the S4 relay status. When active, this indicates that relay S4 is energised.

6/13 S5

Displays the S5 relay status. When active, this indicates that relay S5 is energised.

7/13 S6

Displays the S6 relay status. When active, this indicates that relay S6 is energised.

8/13 S7

Displays the S7 relay status. When active, this indicates that relay S7 is energised.

9/13 S8

Displays the S8 relay status. When active, this indicates that relay S8 is energised.

10/13 S9

Displays the S9 relay status. When active, this indicates that relay S9 is energised.

11/13 S10

Displays the S10 relay status. When active, this indicates that relay S10 is energised.

12/13 S11

Displays the S11 relay status. When active, this indicates that relay S11 is energised.

13/13 S12

Displays the S12 relay status. When active, this indicates that relay S12 is energised.

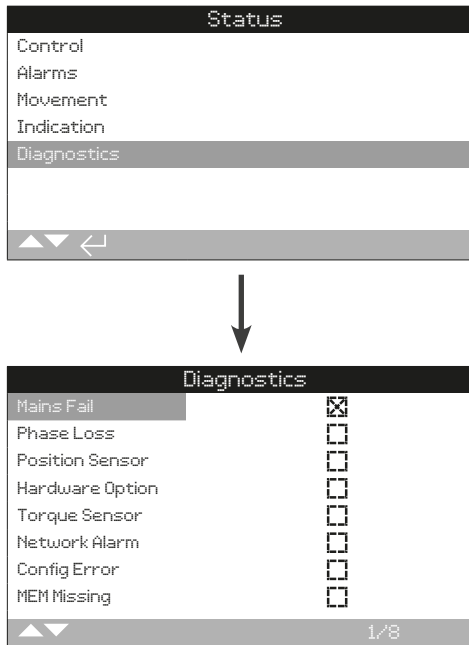

6/8 Network Alarm

Displays the network fault status. When active, this status indicates that a fault has occurred in the network. Check all field connections for continuity and correct connection.

7/8 Config Error

Displays the EEPROM fault status. When active, this status indicates that a fault with the EEPROM has occurred. Check all configuration settings.

8/8 MEM Missing

Displays the EEPROM missing status. When active, this status indicates that the EEPROM is missing. The EEPROM stores all the actuators settings and calibration. If the EEPROM is physically missing, please contact Rotork for further advice.

Diagnostics status

This screen displays the actuators diagnostics status. The checkbox indicates that the fault is present.

To scroll through this information use .

1/8 Mains Fail

Displays the power supply failure status. When active, this status indicates a power supply failure has occurred. If the backlight is still present it is likely that the third phase has been lost. Check all incoming phases.

2/8 Phase Loss

Displays the Phase Loss status. When active, this status indicates that one or more phases have been lost. Only the third phase is monitored so if the backlight is present then check the third phase is present. If the backlight is not present, check all phases.

3/8 Position Sensor

Displays the absolute encoder fault status. When active, this status indicates that a fault with the absolute encoder has occurred. Check the encoder operation and loom.

4/8 Hardware Option

Displays the communication fault status between the main control board and the option board. When active, this status indicates that a communication error has occurred. Check all connections between the option PCB and the main controller PCB.

5/8 Torque Sensor

Displays the fault status of the Torque Sensor. When active, this status indicates that a fault has occurred with the torque sensor. Check the torque sensor and loom.

Data logs, which are able to store vast amounts of operational and environmental information, are provided as standard on the IQ. Due to the nature of the graphical display, information can be displayed locally at the actuator using the supplied Rotork Bluetooth® Setting Tool *Pro*.

The stored information can be used to view, diagnose and trend any type of operational condition that may affect the valve, actuator or process. With asset management becoming preferred, the data log helps to achieve goals set out by process conditions.

Refer to section 1.2 for connecting to the actuator. Once connected, use the four directional arrows to navigate to the main icon menu. From here you can highlight and select the Data log icon:

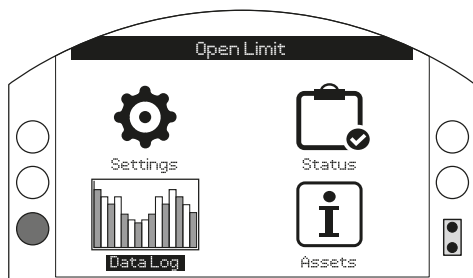

Main Menu

The first time you enter the data log menu, you will be given the opportunity to set the current time and date. This time and date is ONLY for the local display and does not affect the dates when you download the data log for viewing in Insight 2. If you want to set the current time and date, please refer to section 4.6 for details.

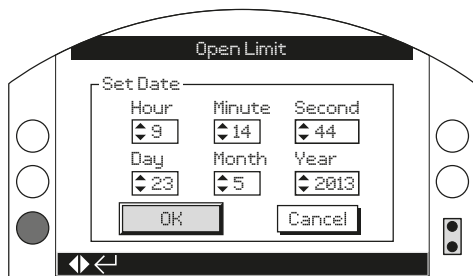

Check the current time and press enter . You will now be shown the main Data log menu below:

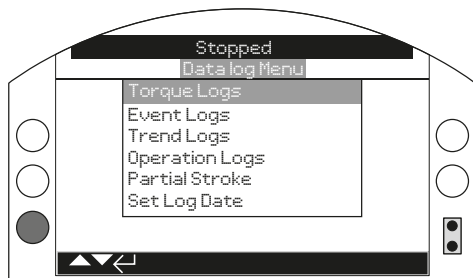

4 Data Log menu	Page
4.1 Torque Logs	49
4.1.1 Graph	49
4.1.2 Valve Torque Profile	50
4.1.3 Valve Torque Reference	50
4.2 Event Logs	51
4.2.1 Control Event Log	51
4.2.2 EError Event Log	55
4.3 Trend Logs	55
4.3.1 Temperature	56
4.3.2 Battery	56
4.3.3 Vibration Average	57
4.3.4 Vibration Peak	57
4.4 Operation Logs	58
4.4.1 Starts Profile	58
4.4.2 Statistics	59
4.4.3 Service Log	60
4.4.4 Bluetooth Log	61
4.5 Partial Stroke Logs	62
4.5.1 Partial Stroke Results	62
4.5.2 Partial Stroke Torque	63
4.6 Set Log Date	63

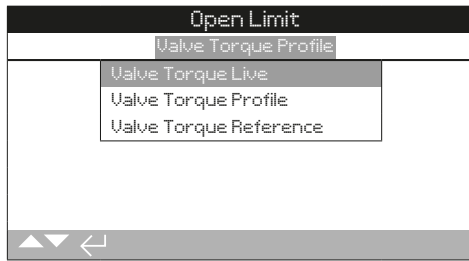

Torque Menu

Press  to view the selected Valve Torque graph.

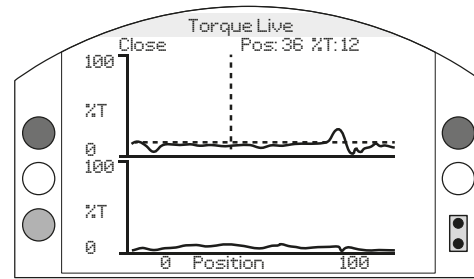



Pos = Position, T = Torque

Valve Torque Live

This screen displays two torque graphs, showing live torque percentage output against the actuator position for open and close directions.

Pressing the  and  arrows moves the cursor between the open and close graphs.

Pressing the  and  arrows moves the cursor along at 1% position increments.

The torque graph will update as the actuator is moving so that the profile can be viewed live during the actuator stroke. Each time the actuator moves from limit to limit the graph will be overwritten with the new data. No data is permanently stored on this page.

4.1.2 Torque Logs – Valve Torque Profile

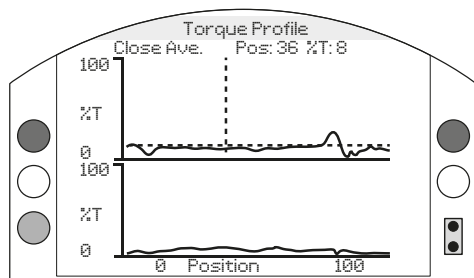

Pos = Position, T = Torque

Valve Torque Profile

The graph displays two torque profiles detailing the average opening and closing torque as a percentage of rated torque by valve position. The data is averaged from the beginning of the log time to the last operation. It is overlaid with a torque graph of the last operation (solid line) for comparison with the average (shaded area).

The Torque Profile graph is useful when determining the amount of torque required to operate the valve throughout stroke. Excess valve torque and tight spots can be diagnosed using this graph to allow for relevant action to be taken.

Key presses

Pressing the and arrows cycles the cursor through the following graphs:

- **Open** - Selects the percentage torque graph in the open direction.
- **Close** - Selects the percentage torque graph in the close direction.
- **Open Ave.** - Selects the average torque graph in the open direction.
- **Close Ave.** - Selects the average torque graph in the close direction.

Pressing the and arrows moves the cursor along at each 1% position increments.

Pressing the key allows you to zoom in on an area to see further detail. Pressing the key cycles through: 0 – 100%, -14 – 10%, and 90 – 115% position views.

4.1.3 Torque Logs – Valve Torque Reference

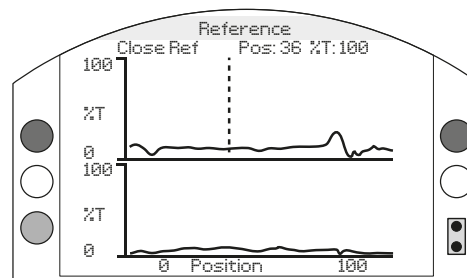

Pos = Position, T = Torque

Valve Torque Reference

The graph displays two torque profiles detailing the opening and closing torque as a percentage of rated torque by valve position. The data is derived from a previously saved valve torque reference (shaded area) and is overlaid with the torque profile (solid line) from the last operation for comparison.

To save a torque profile as a torque reference, first make sure you commission the actuator and valve as per section 2.1. Once commissioned and with full operating conditions present, stroke the valve using either local or remote control through its full limits to collect the data. Once this has been done, navigate to the Torque Reference screen and press . The following message will appear:

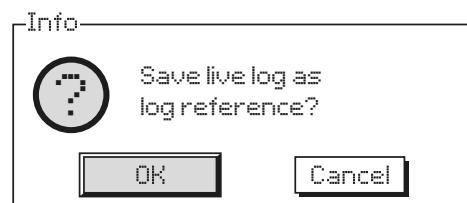

If the reference is required press when OK is selected. The profile will now be stored.

Key presses

Pressing the and arrows cycles through the following:

- **Open** - Selects the percentage torque graph in the open direction.
- **Close** - Selects the percentage torque graph in the close direction.
- **Open Ref** - Selects the previously saved torque profile graph in the open direction.
- **Close Ref** - Selects the previously saved torque profile graph in the close direction.

Pressing the and arrows moves the cursor along at each 1% position increments.

Pressing the key allows you to zoom in on an area to see further detail. Pressing the key cycles through: 0 – 100%, -14 – 10%, and 90 – 115% position views.

To save the valve torque reference, press the key. A prompt will appear asking to confirm OK / Cancel. Use and to select a response and press .

4.2 Data Log – Event Logs

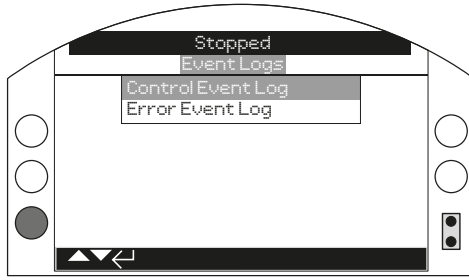

4.2.1 Event Logs – Control Event Log



Event Logs

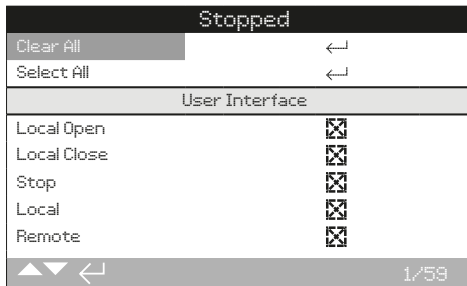

Press  to view the selected Event Log.



Event Log Filter

This screen contains a list of all the possible control parameters that can be shown in the Control Event log. In order to make viewing easier, the user can select the parameters they are interested in viewing. Once selected, these parameters will be listed in the Control Event Log screen.

The checkbox indicates the parameter will be displayed.

To scroll and highlight the control parameters use  and  arrows.

To toggle between show/hide parameter press    .

List of Control parameters

1/59 Clear All - Clears all selected options.

2/59 Select All - Selects all options.

User Interface

3/59 Local Open - Shows/hides local open events.

4/59 Local Close - Shows/hides local close events.

5/59 Stop - Shows/hides stop events.

6/59 Local - Shows/hides local events.

7/59 Remote - Shows/hides remote events.

Remote Hardwired Control

8/59 Open - Shows/hides remote hardwired control open events.

9/59 Close - Shows/hides remote hardwired control close events.

10/59 ESD - Shows/hides remote hardwired control ESD events.

11/59 Maintained - Shows/hides remote hardwired control maintained events.

12/59 Close Interlock - Shows/hides remote hardwired control close interlock events.

13/59 Open Interlock - Shows/hides remote hardwired control open interlock events.

Remote Source 1 Control

14/59 Open - Shows/hides remote source 1 control open events.

15/59 Close - Shows/hides remote source 1 control close events.

16/59 ESD - Shows/hides remote source 1 control ESD events.

17/59 Maintained - Shows/hides remote source 1 control maintained events.

Remote Source 2 Control

18/59 Open - Shows/hides remote source 2 control open events.

19/59 Close - Shows/hides remote source 2 control close events.

20/59 ESD - Shows/hides remote source 2 control ESD events.

21/59 Maintained - Shows/hides remote source 2 control maintained events.

Alarms
22/59 Thermostat - Shows/hides thermostat alarm events.
23/59 Torque Trip OP - Shows/hides torque trip in the open direction alarm events.
24/59 Torque Trip CL - Shows/hides torque trip in the closing direction alarm events.
25/59 Int.Timer Active - Shows/hides Interrupter Timer alarm events.
26/59 Motor Stall - Shows/hides motor stall alarm events.
27/59 Inhibit Time - Shows/hides inhibit time alarm events.
28/59 Monitor Relay - Shows/hides monitor relay alarm events.
29/59 PStroke Fail - Shows/hides partial stroke failure alarm events.
30/59 ControlContention - Shows/hides control contention alarm events.
31/59 Comms Loss - Shows/hides communications loss alarm events.
32/59 Phase Loss - Shows/hides phase loss alarm events.
33/59 Mains Restart - Shows/hides mains restart alarm events.
34/59 Phase Rotation - Shows/hides phase rotation alarm events.

Status
35/59 Moving Open - Shows/hides moving open status events.
36/59 Moving Closed - Shows/hides moving closed status events.
37/59 Contactor CW - Shows/hides clockwise contactor energised status events.
38/59 Contactor ACW - Shows/hides anti-clockwise contactor energised status events.
39/59 Open Limit - Shows/hides actuator open limit status events.
40/59 Closed Limit - Shows/hides actuator closed limit status events.
41/59 Manual - Shows/hides manual engaged status events.
42/59 PStroke Active - Shows/hides partial stroke active status events.

Contacts (Checkbox indicates contact made)
43/59 S1 - Shows/hides contact S1 status.
44/59 S2 - Shows/hides contact S2 status.
45/59 S3 - Shows/hides contact S3 status.
46/59 S4 - Shows/hides contact S4 status.
47/59 S5 - Shows/hides contact S5 status.
48/59 S6 - Shows/hides contact S6 status.
49/59 S7 - Shows/hides contact S7 status.
50/59 S8 - Shows/hides contact S8 status.
51/59 S9 - Shows/hides contact S9 status.
52/59 S10 - Shows/hides contact S10 status.
53/59 S11 - Shows/hides contact S11 status.
54/59 S12 - Shows/hides contact S12 status.

Refer to PUB002-059 for information on the Remote Hand Station.

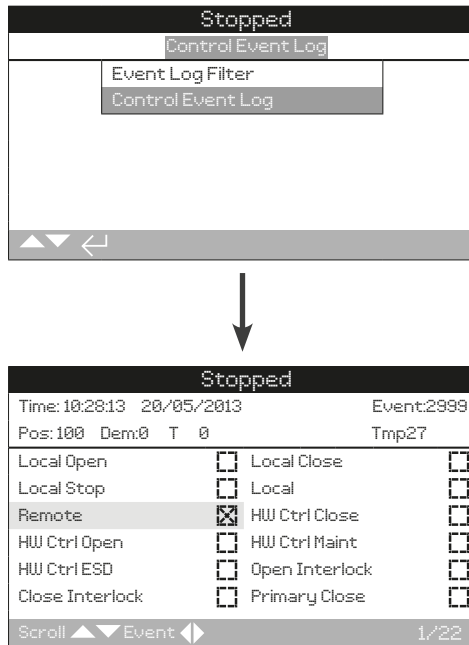

Control Event Log

This screen displays a date and time stamped log of actuator's control events. The parameters that are displayed in this screen are determined by the selections made in the control event filter. To view each event, first select the parameters that are required as per section 4.2.1-1 and then scroll through each event.

As each event is viewed, the parameters selected will report its status along with the current position, demand, torque and temperature:

Key	Parameter
Pos: xxx	= Position in %
Dem: xxx	= Demand in %
T: xxx	= Torque in %
Tmp: xxx	= Temperature in Deg C

The checkbox indicates the event has occurred.

To scroll through the control parameters use ▲ and ▼.

To scroll through the event logs use ◀ and ▶.

4.2.2 Event Logs – Error Event Log

Stopped		
Time: 20:21:20	22/05/2013	Event:150
Battery	<input type="checkbox"/>	Mains Fail <input checked="" type="checkbox"/>
Cust. Sup. Fail	<input checked="" type="checkbox"/>	Phase Loss <input type="checkbox"/>
TrqTrip Mid OP	<input type="checkbox"/>	TrqTrip Mid CL <input type="checkbox"/>
Trq Hi Alarm	<input type="checkbox"/>	Trq HiHi Alarm <input type="checkbox"/>
Motor Stall	<input type="checkbox"/>	Control Alarm <input type="checkbox"/>
Actuator Alarm	<input type="checkbox"/>	Valve Alarm <input type="checkbox"/>
Encoder Alarm	<input type="checkbox"/>	Network Alarm <input type="checkbox"/>
Scroll ▲▼ Event ◀▶		1/5

Error Event Log

This screen displays the parameters of any events classed as an error or alarm. The parameters are not selectable and are displayed by scrolling down. The parameters show both internal and external alarms related to power supplies, valve torque and motor stall events and can be used to diagnose a range of issues.

The checkbox indicates the condition or error has occurred.

To scroll through the error parameters use **▲** and **▼**.

To scroll through the error events use **◀** and **▶**.

- Battery** - Displays the battery status.
- Mains Fail** - Displays the mains power failure status.
- Cust. Sup. Fail** - Displays the customer supply status.
- Phase Loss** - Displays the phase loss status.
- TrqTrip Mid OP** - Displays the open torque trip status.
- TrqTrip Mid CL** - Displays the close torque trip status.
- Trq Hi Alarm** - Displays the Hi alarm status.
- Trq HiHi Alarm** - Displays the Hi-Hi alarm status.
- Motor Stall** - Displays the motor stall status.
- Control Alarm** - Displays the control alarm status.
- Actuator Alarm** - Displays the actuator alarm status.
- Valve Alarm** - Displays the valve alarm status.
- Encoder Alarm** - Displays the encoder alarm status.
- Network Alarm** - Displays the network alarm status.
- Hardwired Fail** - Displays the hardwired control status.
- Comms Loss** - Displays the communications loss status.
- ChkSum Err** - Displays the check sum error status.
- MEM Missing** - Displays the EEPROM missing status.
- Opt Not Detect** - Displays the option not detected status.
- Trq Sensor Fail** - Displays the torque sensor status.
- PStroke Fail** - Displays the partial stroke status.
- Warm Reset** - Displays the software reset status.
- Limp Home** - Displays the Limp Home Status.
- Status** - Internal use only.

4.3 Data Log – Trend Logs

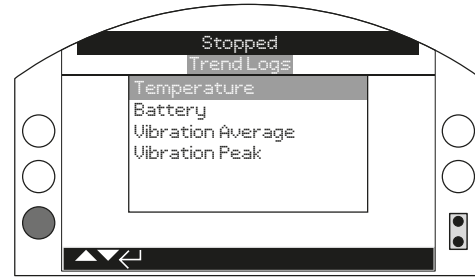

Trend Logs

Press **Ⓢ** to view the selected Trend Log.

4.3.1 Trend Logs – Temperature

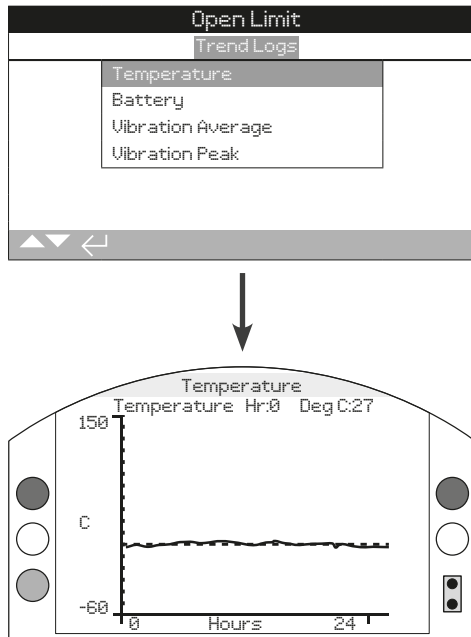

4.3.2 Trend Logs – Battery

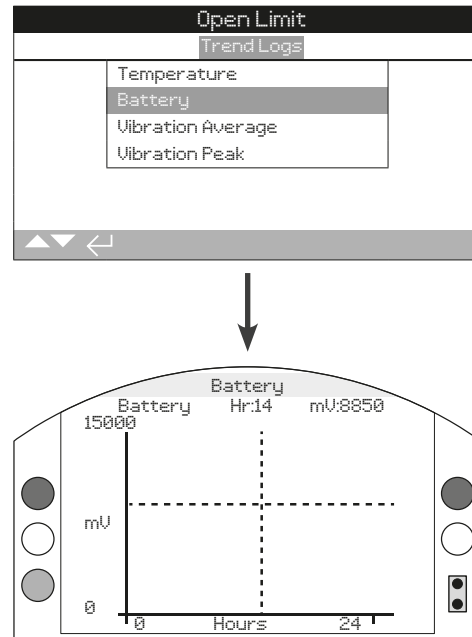

Actuator Temperature

This graph displays a temperature reading over the last 24 hours/30 days/12 months/10 years. The temperature is taken from an internal sensor on the circuit board and can be affected by the heating effect of internal components. It may not reflect external ambient temperature. It can be used to monitor changes in temperature which may have an effect on operational conditions.

Pressing the **←** or **→** arrows moves the cursor along the graph by 1 hour/1 day/1 month/1 year increments.

Pressing the **+** key cycles through the timescales of 24 hours/30 days/12 months/10 years.

Battery Charge

This screen displays a battery level graph in mV over the last 24 hours/30 days/12 months/10 years. Effects on battery life include environmental conditions and usage. Refer to PUB0020-39 for further details on battery types and replacement procedures.

Pressing the **←** or **→** arrows moves the cursor along the graph by 1 hour/1 day/1 month/1 year increments.

Pressing the **+** key cycles through the timescales of 24 hours/30 days/12 months/10 years.

4.3.3 Trend Logs – Vibration Average

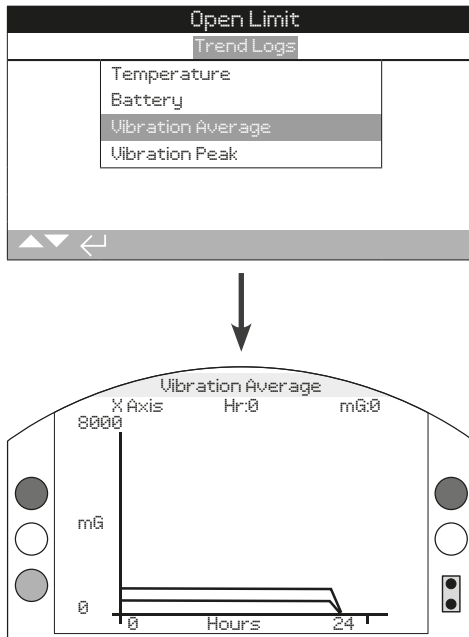

Vibration Average

This screen displays average vibration levels (in mG) over the last 24 hours/30 days/12 months/10 years. The sensor is located on the circuit board and can detect vibration (forces) in three axes. In normal mounting position (handwheel pointing up) you could expect to see around 980 mG constantly acting in the Y axis. With other mounting orientations, the forces measured (nominally) will be different*. Vibration analysis graphs may help the user understand how plant induced vibration affects actuator / valve operation.

* The average vibration graph is intended to measure the vibrational forces over time in order to assist in identifying problematic vibration and is not intended for accurate vibration analysis.

Pressing the **⬆** and **⬇** arrows cycles through the X, Y and Z axis.

Pressing the **⬅** or **➡** arrows moves the cursor along the graph by 1 hour/1 day/1 month/1 year increments.

Pressing the **⏪** key cycles through the timescales of 24 hours/30 days/12 months/10 years.

4.3.4 Trend Logs – Vibration Peak

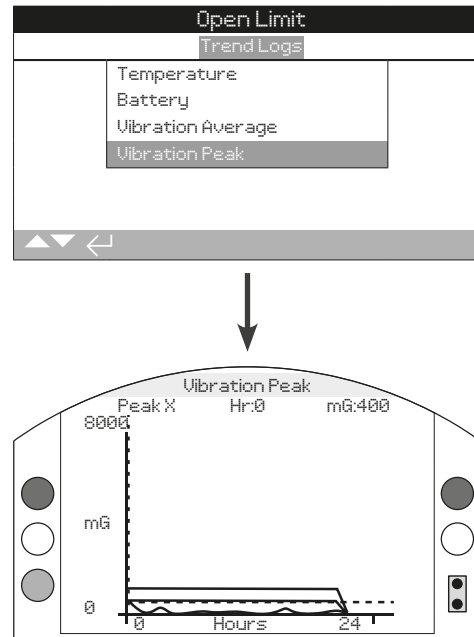

Peak Vibration

This screen displays peak vibration levels over the last 24 hours/30 days/12 months/10 years. The levels shown will be the highest recorded for that period*.

* The peak vibration graph is intended to measure the highest vibrational forces over time in order to assist in identifying problematic vibration and is not intended for accurate vibration analysis.

Pressing the **⬆** and **⬇** arrows cycles through the X, Y and Z axis.

Pressing the **⬅** or **➡** arrows moves the cursor along the graph by 1 hour/1 day/1 month/1 year increments.

Pressing the **⏪** key cycles through the timescales of 24 hours/30 days/12 months/10 years.

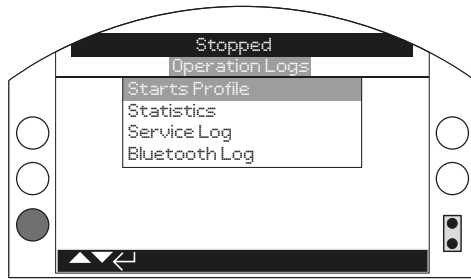

Operation Logs

Press **⏏** to view the selected Operation Logs.

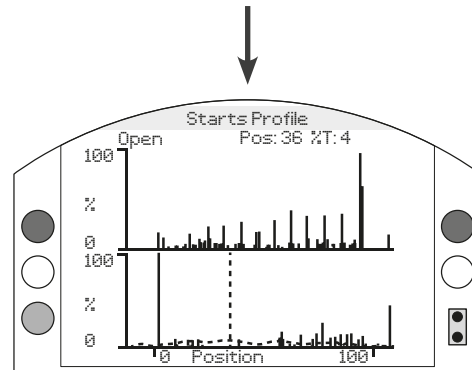
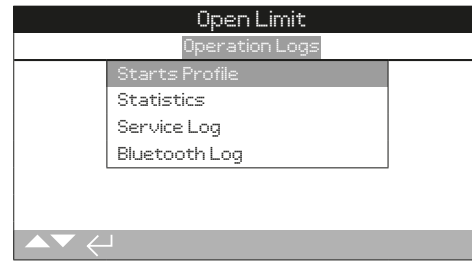

Starts Profile

This screen displays two graphs showing the percentage of total motor starts against the actuator position in the open and close directions. Due to the screen resolution, the percentages can only be displayed in 1% increments. For isolating duty it is normal to see 100% of starts at each end of travel but for modulating duty the graph will be spread as in the example above. To prevent the scaling of the display exceeding the LCD capability, all percentages of starts are referenced to the highest number of starts for any given position and all other positions will show a percentage of the peak. This means however, for repeated equal pulsing throughout travel (i.e. regulating 0%-25%-50%-75%-100%) the percentage of starts will be 100% for each position. The graph is designed to give the user a quick visual indication of the starts profile. For accurate number of starts, please refer to section 4.4.2 Statistics.

Pressing the **⏏** and **⏏** arrows moves the cursor between the open and close graphs.

Pressing the **⏏** and **⏏** arrows moves the cursor along at 1% position increments.

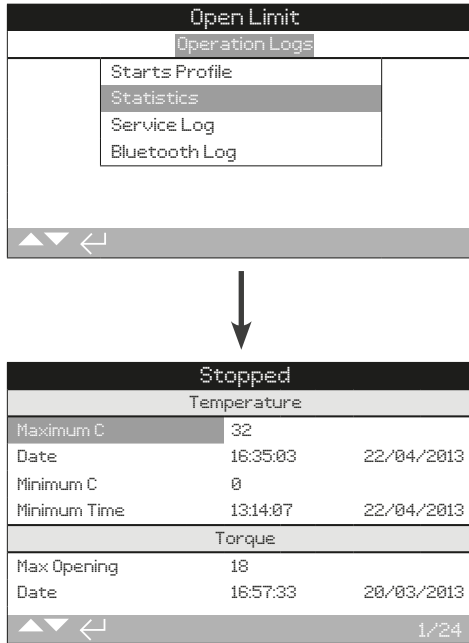

Statistics

This screen displays statistics of actuator operation. Date and times are only accurate if the date/time is set locally as per section 4.6.

To scroll through the statistics log use **⬆** and **⬇**.

Temperature

- 1/24 Maximum C** - Displays the maximum temperature the internal enclosure has reached in degrees Celsius.
- 2/24 Date** - Displays the date and time that the internal enclosure reached the maximum temperature.
- 3/24 Minimum C** - Displays the minimum temperature the internal enclosure has reached in degrees Celsius.
- 4/24 Date** - Displays the date and time that the internal enclosure reached the minimum temperature.

Torque

- 5/24 Max Opening** - Displays the maximum opening torque the actuator has reached.
- 6/24 Date** - Displays the date and time that the actuators maximum opening torque was reached.
- 7/24 Max Closing** - Displays the maximum closing torque the actuator has reached.
- 8/24 Date** - Displays the date and time that the actuators maximum closing torque was reached.
- 9/24 Ave. Torque %** - Displays the actuators average torque as a percentage.

Power

- 10/24 Motor Run Time** - Displays the total motor running time.
- 11/24 On Battery** - Displays the total time the actuator has been on battery power.
- 12/24 Max On Time** - Displays the maximum time the actuator has been powered on.
- 13/24 Max Off Time** - Displays the maximum time the actuator has been powered off.
- 14/24 Power Ups** - Displays the total number of times the actuator has been powered up.

Counts

- 15/24 Clock** - Displays the current date and time (if set locally as in section 4.6).
- 16/24 Total Turns** - Displays the total number of actuator turns.
- 17/24 Max Starts/Hr** - Displays the maximum number of motor starts that occurred in an hour.
- 18/24 Date** - Displays the date and time that the maximum number of motor starts occurred.
- 19/24 Open Starts** - Displays the total number of motor starts in the open direction.
- 20/24 Close Starts** - Displays the total number of motor starts in the closed direction.

Trips

- 21/24 Last Open Limit** - Displays the date and time the actuator last reached its open limit.
- 22/24 Last Close Limit** - Displays the date and time the actuator last reached its closed limit.
- 23/24 Open Reset Time** - Displays the date and time the actuator last moved away from the open limit.
- 24/24 Cls. Reset Time** - Displays the date and time the actuator last moved away from the closed limit.

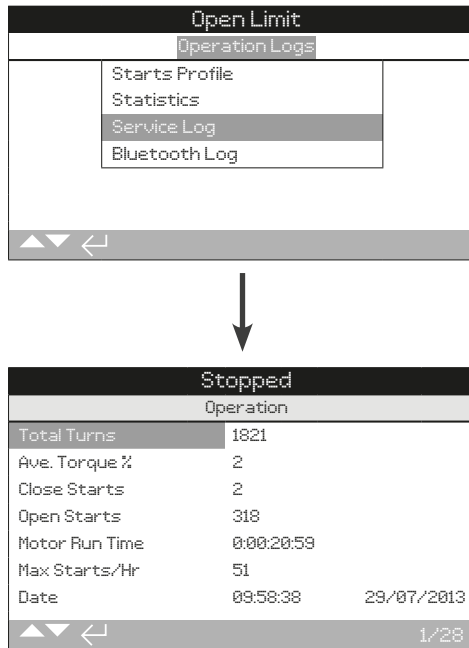

Actuator Service Log

This screen displays the operational data of the actuator. This section is primarily oriented towards operations that affect the servicing of the actuator; therefore some parameters may be repeated from the Statistics Log. Date and times are only accurate if set locally as per section 4.6.

To scroll through the statistics log use  and .

Operation

- 1/28 Total Turns** - Displays the total number of actuator turns.
- 2/28 Ave. Torque %** - Displays the average actuator torque as a percentage of rated torque.
- 3/28 Close Starts** - Displays the number of times the actuator has started to move in the close direction.
- 4/28 Open Starts** - Displays the number of times the actuator has started to move in the open direction.
- 5/28 Motor Run Time** - Displays the total motor run time. Days: Hours: Minutes: Seconds
- 6/28 Max Starts/Hr** - Displays the maximum number of motor starts that have occurred in an hour.
- 7/28 Date** - Displays the time and date that the maximum starts in an hour was recorded. Hours: Minutes: Seconds Day/Month/Year
- 8/28 Last Close Limit** - Displays the last time and date the actuator reached its closed limit. Hours: Minutes: Seconds Day/Month/Year
- 9/28 Last Open Limit** - Displays the last time and date the actuator reached its open limit. Hours: Minutes: Seconds Day/Month/Year.

Close Torque

- 10/28 Max Value %** - Displays the maximum applied close torque as a percentage of rated torque.
- 11/28 Date** - Displays the time and date that the maximum applied close torque percentage was recorded. Hours: Minutes: Seconds Day/Month/Year
- 12/28 Last Torque Trip** - Displays the time and date of the last instance the actuator"s torque trip was activated in the close direction. Hours: Minutes: Seconds Day/Month/Year
- 13/28 Hi Alarm Count** - Displays the number of times the Hi alarm has been triggered in the close direction.
- 14/28 HiHi Alarm Count** - Displays the number of times the Hi/Hi alarm has been triggered in the close direction.

Open Torque

- 15/28 Max Value %** - Displays the maximum applied open torque as a percentage of rated torque.
- 16/28 Date** - Displays the time and date that the maximum applied open torque percentage was recorded. Hours: Minutes: Seconds: Day/Month/Year
- 17/28 Last Torque Trip** - Displays the time and date of the last instance the actuator"s torque trip was activated in the open direction. Hours: Minutes: Seconds Day/Month/Year
- 18/28 Hi Alarm Count** - Displays the number of times the Hi alarm has been triggered in the open direction.
- 19/28 HiHi Alarm Count** - Displays the number of times the Hi/Hi alarm has been triggered in the open direction.

Temperature

- 20/28 Maximum C** - Displays the maximum internal actuator temperature in degrees Celsius.
- 21/28 Date** - Displays the time and date stamp when the maximum reached actuator temperature was recorded. Hours: Minutes: Seconds: Day/Month/Year
- 22/28 Minimum C** - Displays the minimum internal actuator temperature in degrees Celsius.
- 23/28 Date** - Displays the time and date stamp when the minimum reached actuator temperature was recorded. Hours: Minutes: Seconds: Day/Month/Year.

Power

- 24/28 On Battery** - Displays the total time the actuator has been awake on battery power. Days: Hours: Minutes: Seconds
- 25/28 Power Ups** - Displays the total number of actuator power ups.
- 26/28 Max On Time** - Displays the longest time that the actuator has been powered on in one instance. Days: Hours: Minutes: Seconds:
- 27/28 Max Off Time** - Displays the longest time that the actuator has been powered off in one instance. Days: Hours: Minutes: Seconds:

Service

- 28/28 Last Service** - Displays the time and date of the actuators last service. Hours: Minutes: Seconds: Day/Month/Year.

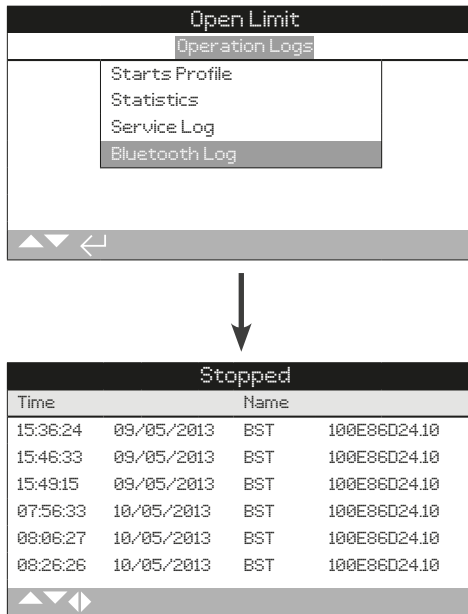

Bluetooth Log

This screen displays a log of all Bluetooth device connections. Each device that has successfully connected leaves a footprint of its device name, MAC address and access level, along with a time and date stamp (if set locally as per section 4.6).

To scroll through the Bluetooth log use   and  .

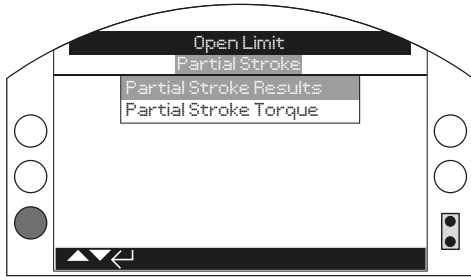

Partial Stroke Logs

Press **6** to view the selected Partial Stroke Log.

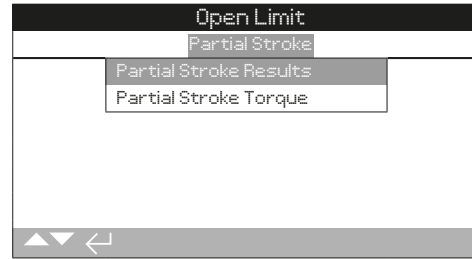

Stopped	
Time	Result
09:10:56	02/01/2013
10:05:02	14/02/2013
10:23:24	16/02/2013
12:24:43	19/03/2013
14:38:57	20/05/2013-
15:02:23	26/05-/2013

Partial Stroke Results

This screen displays the results of the Partial Stroke movements that have taken place. The results are displayed as a simple pass or fail next to the date and time stamp of each partial stroke (if set locally as per section 4.6).

To scroll through the Partial Stroke Logs use **6** **6** and **6** **6**.

4.5.2 Partial Stroke Logs – Partial Stroke Torque

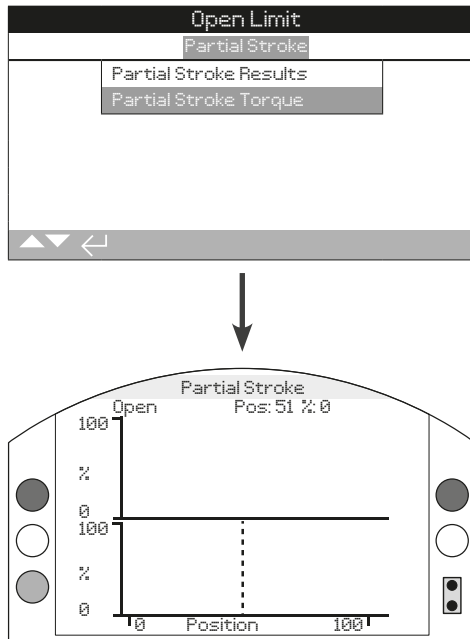

Partial Stroke Torque

This screen displays a torque graph of the last partial stroke movement. This graph is used to plot the torque required to operate the valve during the last partial stroke operation and may help to analyse problems with the valve and its condition.

Pressing the **↶** and **↷** arrows moves the cursor between the open and close graphs.

Pressing the **↶** and **↷** arrows moves the cursor along at 1% position increments.

4.6 Data Log – Set Log Date

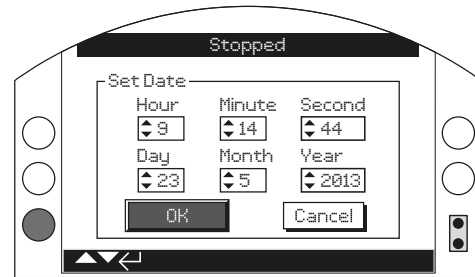

Set Log Date

This screen allows the user to locally set the current date and time for the data log. This time and date is **only** used for local indication and does not affect the stored data when downloaded to a PC device when viewing within Rotork Insight 2 software.

To select the date and time fields use **↶** and **↷** arrows.

To change the selected date and time fields use **↶** and **↷** arrows.

To confirm the changes select OK and press **↵**.

Asset management is an increasingly desirable requirement in process industries and can be used to manage valve asset performance, availability and maintenance schedules. Information regarding the process, valve and actuator can be stored in the IQ3. In addition, the installation and commissioning dates along with the service history of the actuator can be recorded. Asset management alarms can also be set to indicate possible maintenance required.

Stored asset information can be shown on the actuator display using the supplied Rotork Bluetooth® Setting Tool *Pro*. When the actuator configuration file is downloaded, using the Bluetooth® Setting Tool *Pro* or directly with a PC running Insight 2, asset data is appended along with the actuator build and configuration data. The actuator configuration and asset data can be exported as a CSV file from Insight 2.

It is important that data regarding the valve-actuator tag, valve details and process information are populated by the user or their agent. Rotork will populate actuator build data automatically. Other applicable data will be populated when contracted to commission or service the actuator.

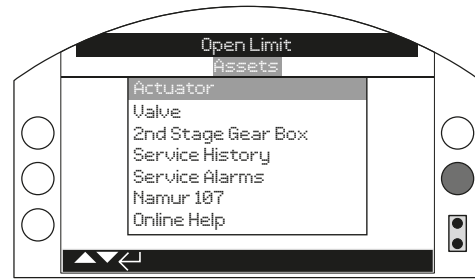
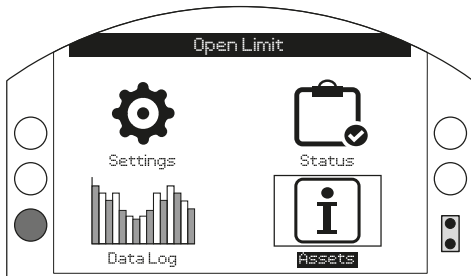

Main Menu

The asset menu is split into different categories for each type of data. The full assets menu structure is shown below:

5. Assets menu		Page
5.1	Actuator	65
5.1.1	Actuator Nameplate	65
5.1.2	Actuator Std Build	67
5.1.3	Actuator Opt Build	67
5.2	Valve	68
5.3	2nd Stage Gear Box	68
5.4	Service History	69
5.5	Service Alarms	69
5.6	NAMUR 107	70
5.7	Online Help	71

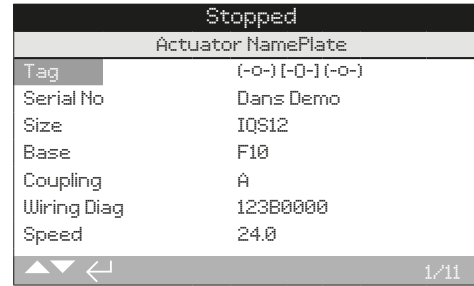
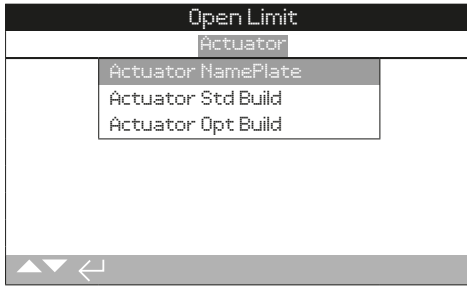

Actuator Assets

IQ range actuators are fully configurable with a large number of optional extras or build variants. Actuator information is split to improve visibility of relevant information to the operator.

- 5.1.1 Actuator Nameplate
- 5.1.2 Actuator Standard Build
- 5.1.3 Actuator Option Build

Actuator Name Plate Information

This screen displays the nameplate information of the actuator. Should the physical nameplate become damaged or lost, the information for the actuator will remain accessible. The information shown is read only with the exception of the actuator Tag which can be edited by the user after entering a valid password.

To change, press  to select the highlighted field.

Use  and  to scroll through alphabetic and numerical figures to display the required character.

Use  to move to the next character.

Use  to delete the previous character.

Use  to save the information.

1/11 Tag

The tag entry in Actuator Nameplate will be shown on the actuators set home screen display. The tag name entered should be the valve and/or actuator reference that identifies the asset within the site process control scheme. If the tag was supplied at time of order, Rotork will populate the entry automatically.

The user may edit the tag after a valid password has been entered.

2/11 Serial No

Displays the actuator serial number. This should always be quoted when making any enquiry to Rotork or our agents.

3/11 Size

Displays the actuator model and size, for example "IQ25" or "IQT125".

4/11 Base

Displays the actuator base size according to standard ISO 5210 / 5211 for metric bases and MSS SP-101 / SP-102 for imperial bases, for example "F14".

5/11 Coupling

Displays the actuator drive coupling type and designation according to standard ISO5210 / 5211. The drive couplings available are A, Z3*, B1, B3, B4 (B only for IQT).

*Z3 coupling is an extended length version of an "A" coupling but with the same stem acceptance dimension. It is a Rotork standard and is not referenced in standard ISO5210.



5.1.1 Actuator – Actuator Nameplate *continued*

6/11 WiringDiag

Displays the actuator Wiring Diagram number. Standard wiring diagrams can be downloaded from <http://wiring.rotork.com> using the wiring diagram selector link.

Wiring Diagrams prefixed "WD" are non-standard and user specific. For a copy, contact Rotork.

7/11 Speed

Displays the actuator output speed in RPM. If a 2nd stage gearbox is used in combination with the actuator, the combination output speed will be subject to the gearbox ratio. For multi-turn combinations (gearbox types prefixed "IB", "IS" or "MTW" refer to 5.3) divide the displayed speed by the gearbox ratio to obtain the combination output speed in rpm.

For quarter-turn combinations (gearbox types prefixed "IW", "IWD" or "MOW" refer to 5.3) divide the gearbox ratio by 4 then divide the result by the actuator speed (RPM) and multiply by 60 to get the 90° operating time in seconds.

For actuator types "IQL" or "IQML", the speed quoted is the linear output travel in mm/second.

For IQT builds, speed is quoted in seconds per 90° operation at maximum rated speed.

8/11 MaxTorque

Displays the actuator maximum (catalogue) rated torque in Newton metres (Nm). The maximum rated torque is that at 100% torque setting. The torque may be set in the range 40% to 100%, refer to 2.1. Unless specified with order, on despatch, the torque will be set at 40%.

9/11 Enclosure

Displays the actuator enclosure type. For full details, refer also to the actuator physical nameplate.

10/11 Supply

Displays the actuator power supply build voltage. The build voltage is that specified by the end user and must be used when operating the actuator at all times.

For actuators built with 3 phase AC power supplies, the voltage can be confirmed as three phase if IQ is shown in 3/11.

For actuators built with single phase AC power supplies, the voltage can be confirmed as single phase if IQS is shown in 3/11.

For actuators built with DC power supplies, the voltage can be confirmed as DC if IQD is shown in 3/11.

For any power supply queries please contact Rotork quoting the actuator serial number.

As standard, actuators are specified to operate at their stated catalogue torque performance with a tolerance of nominal voltage +/- 10%. Duty performance is specified at nominal voltage +/-0%.

Excess or insufficient voltage supply may cause increased motor heating.

For valve maker FAT purposes, where the actuator is built for a power supply different to that available at the valve maker's or integrator's site, contact Rotork prior to powering up the actuator.

11/11 Build Date

Displays the actuator production test date. YearMonthDay (YYYYMMDD).

5.1.2 Actuator – Actuator Std Build

Open Limit	
User Interface	
Serial No	SERIAL USER INTERFACE
Software Version	v104 (3708)
BT Mac	00:07:00:5a:80:43
FCC ID:	00QWT12
IC:	5123A-BGTWT12A
Telec R	205 WW 2010067
Control Board	
 1/22	

Actuator Standard Build Information

This screen allows the user to view the standard build details of the actuator. All information shown is read only.

To scroll through this information use  and .

User Interface

1/22 Serial No – Displays the serial number of the user interface module.

3/22 Software Version – Displays the software version of the user interface module.

4/22 BT Mac – Displays the Bluetooth MAC address of the user interface module.

5/22 FCC ID: – Displays the user interface modules Federal Communications Commission Bluetooth identification.

6/22 IC: – Displays the user interface modules Industry Canada Bluetooth identification.

7/22 Telec R – Displays the user interface modules Telecom Engineering Center Bluetooth identification.

Control Board

8/22 Serial No – Displays the serial number of the control board.

10/22 Software Version – Displays the software version of the control board.

11/22 SIL SW Version – Displays the software version of the control board for SIL actuators.

Position Sensor

12/22 Serial No – Displays the serial number of the position sensor.

14/22 Software Version – Displays the software version of the position sensor.

15/22 Hardware Version – Displays the hardware version of the position sensor of SIL actuators.

16/22 SIL SW Version – Displays the software version of the position sensor for SIL actuators.

Torque Sensor

17/22 Serial No – Displays the serial number of the torque sensor.

IQT3 Motor Control Board

19/22 Software Version – Displays the software version of the IQT3 Motor Control Board.

20/22 Serial No – Displays the serial number of the IQT3 Motor Control Board.

Battery Back Up

22/22 Software Version – Displays the software version of the Battery Back Up.

5.1.3 Actuator – Actuator Opt Build

Close Limit	
Option1	
Type	Analogue
Serial No	1227BX0160002901=10
Software Version	v105 (843)
Option2	
Type	Relays
Serial No	1216BX0250004802=12
Software Version	v102 (1919)
 1/16	

Actuator Option Build Information

This screen allows the user to view the details for any options fitted to the actuator. Up to four options can be fitted to the IQ3 (this is dependent on number of terminals available and inter-option compatibility).

To scroll through this information use  and .

Option 1

1/16 Type – Displays the type of option fitted.

2/16 Serial No – Displays the serial number of the option board fitted.

4/16 Software Version – Displays the software version of the option fitted.

Option 2

5/16 Type – Displays the type of option fitted.

6/16 Serial No – Displays the serial number of the option board fitted.

8/16 Software Version – Displays the software version of the option fitted.

Option 3

9/16 Type – Displays the type of option fitted.

10/16 Serial No – Displays the serial number of the option board fitted.

12/16 Software Version – Displays the software version of the option fitted.

Option 4

13/16 Type – Displays the type of option fitted.









14/16 Serial No – Displays the serial number of the option board fitted.

16/16 Software Version – Displays the software version of the option fitted.

Stopped	
Valve	
Tag	DN150-C
Serial No	BU278904
Type	Butterfly
Size / DN	4"
Manufacturer	Triumph
Service Fluid	ProcessOil
Service Temp	130C

Valve Information

This screen allows the user to view and edit information about the attached valve, once a valid password has been entered. This may be useful for displaying the valve details if the valve tag plate is missing, or for matching a valve to an actuator after valve/actuator repair.









- Press   to navigate through the settings.
- Press  to edit the selected setting.
- Press   to scroll through alphanumeric characters.
- Press  to move to the next character.
- Press  to delete the current character.
- Press  to save the new setting value.
- Press  to escape without saving.

- 1/10 Tag** – Displays the valve tag.
- 2/10 Serial No** – Displays the serial number of the valve.
- 3/10 Type** – Displays the valve type.
- 4/10 Size / DN** – Displays the valve size.
- 5/10 Pressure / DN** – Displays the pressure of the valve.
- 6/10 Manufacturer** – Displays the valve manufacturer.
- 7/10 Service Fluid** – Displays the valve service fluid.
- 8/10 Service Temp** – Displays the valve service temperature.
- 9/10 Location** – Displays the recorded location of the valve.
- 10/10 Installation Date** – Displays the installation date of the valve. YearMonthDay (YYYYMMDD).

Stopped	
2nd Stage Gear Box	
Serial No	Z123456789
Type	IB12
Ratio	6:1
MA	5.1

Gearbox Information

This screen allows the user to view information about the attached gearbox and edit this information once a valid password has been entered.

- To edit information, use  and  to select the highlighted field.**
- To change, press .**
- Use  and  to scroll through alphabetic and numerical figures to display the required character.**
- Use  to move to the next character.**
- Use  to delete the previous character.**
- Use  to save the information.**
- To escape without saving press .**

- 1/4 Serial No** – Displays the serial number of the gearbox.
- 2/4 Type** – Displays the gearbox type.
- 3/4 Ratio** – Displays the gearbox ratio. This is the number of actuator output turns required to output one full gearbox turn.
- 4/4 MA** – Displays the gearbox mechanical advantage. This is the factor that the actuator output torque is multiplied by to give the actuator/gearbox combination output torque.

Stopped	
Service History	
FAT Date	20130225
Commission Date	20130319
Inspection Date	20130621

Service History Information

This screen allows the user to view and edit information about the actuator’s service history, once a valid password has been entered.

To edit information, use **↶** and **↷** to select the highlighted field.

To change, press **↵** to select the field.

Use **↶** and **↷** to scroll through alphabetic and numerical figures to display the required character.

Use **→** to move to the next character.

Use **↶** to delete the previous character.

Use **↵** to save the information.

To escape without saving press **↵**.

1/3 FAT Date – Displays the actuator factory acceptance test date. YearMonthDay (YYYYMMDD).

2/3 Commission Date – Displays the actuator commission date. YearMonthDay (YYYYMMDD).

3/3 Inspection Date – Displays the actuator inspection date. YearMonthDay (YYYYMMDD).

Note: the date format for service history attributes may vary depending on user preference.



Stopped	
Open Torque	
Hi Alarm %	75%
HiHi Alarm %	80%
Close Torque	
Hi Alarm %	50%
HiHi Alarm %	85%
Misc Trip Levels	
Max Starts/Hr	1200

Service Alarms

This screen allows the user to set actuator service alarms if a valid high level password has been entered. Actuator service alarms are meant for indication only and will aid the user to schedule effective maintenance of the actuator/valve. Service torque alarms will only display a visual alarm and do not act in the same way as a torque trip alarm.

Alarms can be set to activate when a selected condition has occurred. This is a visual indication displayed locally at the actuator. The user can also set the Amber LED to flash when one or more of the set conditions are in an alarm state. Refer to 2.2.2. In addition, for remote monitoring, an output relay can be set to indicate when one or more service alarm conditions are active. Refer to 2.2.1.

Typical uses

Torque level detection: For example, if the application requires a torque trip level to be set at 80%, but the user wants to know when the valve torque demand reaches a high level, then the user can set the Hi Alarm to 70%. If the user also wants to know when a mid-travel torque trip is imminent, they can set the Hi Hi Alarm to 75%.

To prevent spurious torque level alarms being generated, the Hi and Hi Hi Alarms ignore valve seating torque trips. They are only generated if Mid-travel torque exceeds the levels set for the service alarms.

To edit the alarms use **↶** and **↷** to highlight the required field.

To change, press **↵** to select the field.

Use **↶** and **↷** to scroll through percentage torque or numbers to display required value.

Use **↵** to save the information.

To escape without saving press **↵**.



5.5 Assets – Service Alarms *continued*

Open Torque

1/10 Hi Alarm % - Allows the user to set a value for an open torque alarm. E.g. 70%.

2/10 HiHi Alarm % - Allows the user to set a value for a second open torque alarm. E.g. 75%.

Close Torque

3/10 Hi Alarm % - Allows the user to set a value for a close torque alarm. E.g. 70%.

4/10 HiHi Alarm % - Allows the user to set a value for a second close torque alarm. E.g. 75%.

Misc Trip Levels

5/10 Max Starts/Hr – Allows the user to set a value for the max starts per hour alarm. E.g. 50 starts.

6/10 Total Starts – Allows the user to set a value for the total starts alarm. E.g. 5000 starts.

7/10 Total Turns – Allows the user to set a value for the total turns alarm. E.g. 15,000 turns.

8/10 Vibration – If the vibration level, which is set by the customer, is reached the alarm will trigger. It can be set between 1000mG and 8000mG.

Service

9/10 Interval (Months) – Allows the user to set an alarm for the next service due. Displays number of months between each service.

Alarms

10/10 Clear Active Alarms – Clears all active alarms.

5.6 Assets – NAMUR 107

Close Limit				
NAMUR Level	MAN	OOS	FNC	FAI
Battery Low	<input checked="" type="checkbox"/>	<input type="checkbox"/>	<input type="checkbox"/>	<input type="checkbox"/>
Local Ctrl Fault	<input type="checkbox"/>	<input type="checkbox"/>	<input type="checkbox"/>	<input type="checkbox"/>
Mains Fail	<input type="checkbox"/>	<input type="checkbox"/>	<input type="checkbox"/>	<input type="checkbox"/>
Thermostat	<input type="checkbox"/>	<input type="checkbox"/>	<input type="checkbox"/>	<input type="checkbox"/>
Serv. Contactor	<input type="checkbox"/>	<input type="checkbox"/>	<input type="checkbox"/>	<input type="checkbox"/>
Service Due	<input type="checkbox"/>	<input type="checkbox"/>	<input type="checkbox"/>	<input type="checkbox"/>
Hi Hi Torq. Alarm	<input type="checkbox"/>	<input type="checkbox"/>	<input type="checkbox"/>	<input type="checkbox"/>

NAMUR 107 Settings

This screen allows the user to view alarms for NAMUR 107 recommendations and set these alarms once a valid password has been entered. The NAMUR 107 diagnostics framework splits actuator condition statuses into four groups. This is based on the outcome severity of an active condition or the type of condition shown. The four settings available for NAMUR 107 diagnostics are:

NAMUR Allocation	Description	Alarm
MAN	Maintenance required	N107 Maintenance
OOS	Out of specification	N107 Out of Specification
FNC	Function check	N107 Function Check
FAI	Failure	N107 Failure

NAMUR 107 alarms are meant for indication only and will alert the user to potential operational issues with the actuator/valve.

Alarms can be set to activate when a selected condition has occurred. For remote monitoring, an output relay can be set to indicate an N107 alarm type is active, refer to 2.2.1. The NAMUR 107 system enables multiple actuator conditions to be monitored through one relay output remotely. This will initiate further investigation into the root cause of the problem.

Typical uses

For example, a process controller requires detailed N107 diagnostics to integrate a new process into an existing NAMUR 107 system. Particular actuator conditions will be monitored and assigned to user specified N107 alarms for monitoring. Each N107 alarm can be allocated to a relay output to provide remote diagnostics for various actuator conditions, refer to 2.2.1.

The Battery Low, Service Due and Hi Torque Alarm conditions are assigned to the N107 Maintenance category. Should one of these conditions become active, an output relay, correctly configured for the N107 Maintenance alarm, will indicate a maintenance issue. The operator will then be able to check the status of the actuator to determine which of the three allocated conditions are active and find the appropriate solution.

Other conditions can be configured to the remaining NAMUR 107 categories and integrated into the system appropriately.

To edit information use and to highlight the required field.

To change, press to select /deselect the field.

- 1/24 Battery Low** – Allows the user to set NAMUR 107 diagnostics for battery charge low.
- 2/24 Local Ctrl Fault** – Allows the user to set NAMUR 107 diagnostics for a fault occurring with the local control.
- 3/24 Mains Fail** – Allows the user to set NAMUR 107 diagnostics for mains power failure.
- 4/24 Thermostat** – Allows the user to set NAMUR 107 diagnostics for a thermostat trip occurring.
- 5/24 Serv. Contactor** – Allows the user to set NAMUR 107 diagnostics for contactor service required.
- 6/24 Service Due** – Allows the user to set NAMUR 107 diagnostics for actuator service due. Refer to 5.5.
- 7/24 Hi Hi Torq. Alarm** – Allows the user to set NAMUR 107 diagnostics for the Hi Hi torque alarm. Refer to 5.5.
- 8/24 Hi Torque Alarm** – Allows the user to set NAMUR 107 diagnostics for the Hi torque alarm. Refer to 5.5.
- 9/24 Motor Starts** – Allows the user to set NAMUR 107 diagnostics for motor starts. Refer to 5.5.
- 10/24 Total Turns** – Allows the user to set NAMUR 107 diagnostics for total turns. Refer to 5.5.
- 11/24 Monitor Relay** – Allows the user to set NAMUR 107 diagnostics for monitor relay. Refer to 2.2.1.
- 12/24 Control Fail** – Allows the user to set NAMUR 107 diagnostics for control failure.
- 13/24 Actuator Fail** – Allows the user to set NAMUR 107 diagnostics for actuator failure.
- 14/24 Comms Loss** – Allows the user to set NAMUR 107 diagnostics for communications loss.
- 15/24 Opt Not Detect** – Allows the user to set NAMUR 107 diagnostics for option card not detected.
- 16/24 PStroke Fail** – Allows the user to set NAMUR 107 diagnostics for partial stroke failure. Refer to 2.3.2-3.
- 17/24 Valve Obstructed** – Allows the user to set NAMUR 107 diagnostics for valve obstructed.
- 18/24 Valve Jammed** – Allows the user to set NAMUR 107 diagnostics for valve jammed.
- 19/24 Pos. Limp Home** – Allows the user to set NAMUR 107 diagnostics for position sensor reduced functionality.
- 20/24 End Travel Mov.** – Allows the user to set NAMUR 107 diagnostics for actuator travel beyond set limits.
- 21/24 Net. Card Fault** – Allows the user to set NAMUR 107 diagnostics for network card fault.
- 22/24 Cust. Sup. Fail** – Allows the user to set NAMUR 107 diagnostics for customer supply failure.
- 23/24 Valve Travel Time** – Allows the user to set NAMUR 107 diagnostics for valve travel time.
- 24/24 Wrong Dir. Det.** – Allows the user to set NAMUR 107 diagnostics for wrong direction detected.

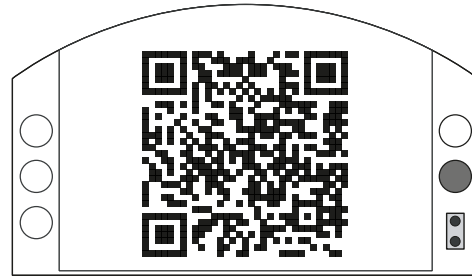

Rotork Support

This screen displays a QR code to direct users to the support section of the Rotork website. This page enables the user to source documentation, software and training resources for Rotork products.

rotork®



www.rotork.com

A full listing of our worldwide sales and service network is available on our website.

UK
Rotork plc
tel +44 (0)1225 733200
email mail@rotork.com

USA
Rotork Controls Inc.
tel +1 (585) 247 2304
email info@rotork.com

PUB002-040-00
Issue 02/22

Original instructions: English language version only. As part of a process of on-going product development, Rotork reserves the right to amend and change specifications without prior notice. Published data may be subject to change. For the very latest version release, visit our website at www.rotork.com

The name Rotork is a registered trademark. Rotork recognises all registered trademarks. The *Bluetooth*® word mark and logos are registered trademarks owned by Bluetooth SIG, Inc. and any use of such marks by Rotork is under license. Published and produced in the UK by Rotork. POLTG0222